

## Panel mounting appliance inlet, straight - flange 85x85, fixing centers 70x70

Product description	
BALS-Prd.-Nr	28106
EAN	4024941281065
Product category	Panel mounting appliance inlet, straight
Current	32A
Number of poles	4p
Arrangement of phases	3P+PE
Position of earth contact	6 h
Voltage	380 - 415V~
Frequency	50/60Hz
Protection degree	IP44
Colour code	red RAL 3000
Colour of appliance	Collar red RAL 3000, Enclosure grey RAL 7035
Connection design	with screw terminal
Maximum conductor size	6,0 qmm
Cable entry	other
Height	85mm
Width	85mm
Depth	86mm

Product description	
Flange size vertical in mm	85mm
Flange size horizontal in mm	85mm
Drill hole dist. vertical mm	70mm
Drill hole dist. horizontal mm	70mm
Material of enclosure	Polyamide
Contacts	The contact carrier is made of polyamide, The contacts are brass

Additional technical properties	
	A retaining device to match the hinged cover of the connector must be provided to ensure the latching feature

Logistics data	
Weight/pcs	0.215 kg / Piece
Packaging	Bag
Content amount	1 ST
EAN	4024941281065
Length	86 mm
Width	85 mm
Height	85 mm
Weight	0.216 kg
Volume	621.35 ccm
Packaging	Carton

Logistics data	
Content amount	10 ST
EAN	4024941834124
Length	245 mm
Width	177 mm
Height	185 mm
Weight	2.283 kg
Volume	7,140 ccm

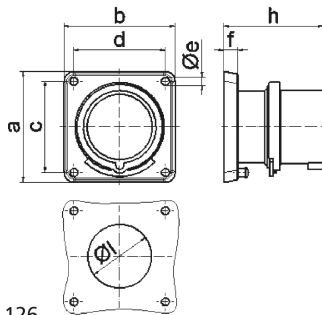

5 MB 126

Ampere Polzahl	16 3	16 4	16 5	32 3	32 4	32 5
a	85,0	85,0	85,0	85,0	85,0	85,0
b	85,0	85,0	85,0	85,0	85,0	85,0
c	70,0	70,0	70,0	70,0	70,0	70,0
d	70,0	70,0	70,0	70,0	70,0	70,0
e ø	6,3	6,3	6,3	6,3	6,3	6,3
f	11,0	11,0	11,0	11,0	11,0	11,0
h	75,5	75,0	76,5	85,0	85,0	85,0
l ø	49,0	49,0	49,0	49,0	49,0	49,0
Leiter mm <sup>2</sup> min	1	1	1	2,5	2,5	2,5
Leiter mm <sup>2</sup> max	2,5	2,5	2,5	6	6	6