

STRL 610.1125.840/DALI

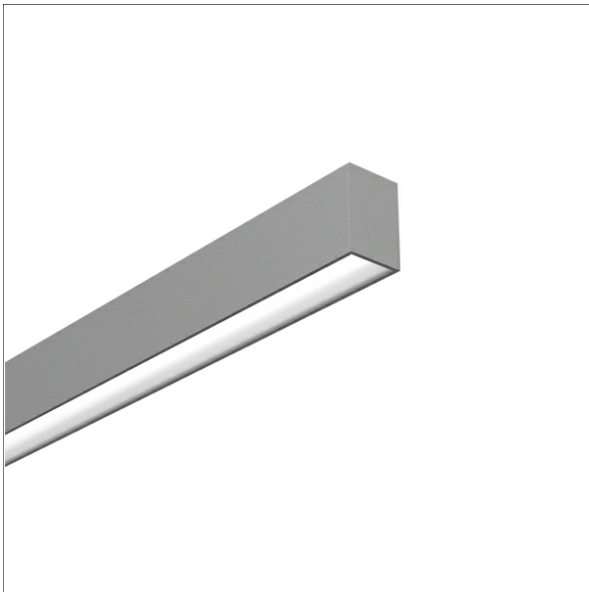

Farbe	Artikelnummer	EAN
silber eloxiert	667757	4043544771049
schwarz	667758	4043544771056
weiß	667759	4043544771063

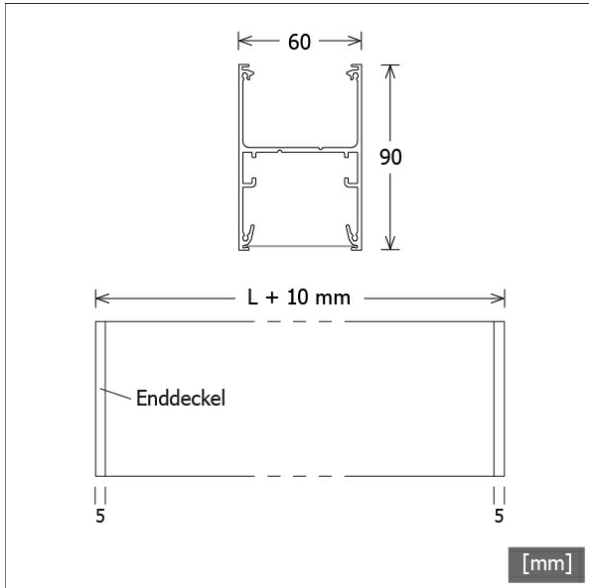

Beschreibung

- Lichtmodul als Fixlänge zur Realisierung von variablen Lichtbandsystemen
- für sehr große Längen geeignet
- hohe Wartungsfreundlichkeit
- keine UV- und Wärmestrahlung
- hochwertiges Aluminiumprofil für Decken- oder Pendelmontage
- integriertes LED-Lichtband mit gewölbtem PMMA-Diffusor für homogene Lichtverteilung
- erforderliche Systemkomponenten separat bestellen
- einschiebbare opale Diffusorfolien in verschiedenen Längen und Abstrahlcharakteristiken
- Montage über Anbauklammern oder Drahtseilabhängung
- steckerfertig für Durchgangsverdrahtung
- Betriebsgerät (LED-Konverter DALI, dimmbar) integriert

Hinweise

Die thermische Längenausdehnung des Aluminiumprofils beträgt bei $dT = 10$ Kelvin 0.3 mm pro Meter.

Standardoptionen



Sonderoptionen



Lichttechnik / Normen

Leuchtmittel	LED linear / CRI 80 / max. 4000 K
Lebensdauer	L90 B50 50.000 h L80 B50 100.000 h L80 B20 50.000 h
Systemleistung	29.6 W
Leuchten-Lichtstrom	max. 3520 lm
Systemeffizienz	105.06 lm/W
Moduleffizienz	164.17 lm/W
UGR 4H/8H 70/50/20	25.0/25.5 (C0/C90)
Versorgungsspannung	220 - 240 V / 50 Hz
Schutzklasse	I
Schutzart	IP20

Abmessungen / Gewichte

Länge	1125 mm
Breite	60 mm
Höhe	90 mm
Nettogewicht	3.33 kg
Bruttogewicht	3.64 kg

STRL 610.1125.840/DALI

STRL 610.1125.840/DALI

StraitLine | Light-Module (Opal Diffuse_si_wh, 1xLED 30W 840/4000K 3110lm)

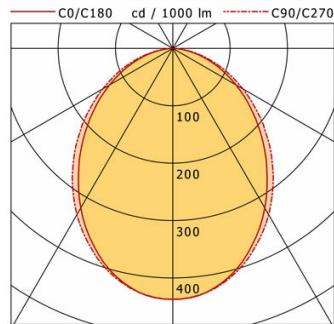

	C0	C90	C180	C270
0°	437	437	437	437
15°	405	409	405	409
30°	321	335	321	335
45°	220	239	220	239
60°	128	141	128	141
75°	51	57	51	57
90°	0	0	0	0
cd / 1000 lm				

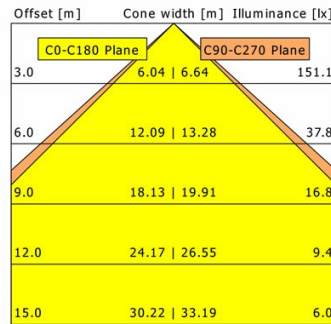

η	LED
Efficiency	104 lm/W
Direct/Indirect	↓ 100% / ↑ 0%
System Power	30 W
UGR	X=4H, Y=8H
Reflection factors	70/50/20
UGR C0/C180	25.0
UGR C90/C270	25.5
CIE Flux Codes	53 83 97 100 100
Ra/CRI	>80

LTS

STRL 610.1125.840/DALI

StraitLine | Light-Module (Deep Beam nanoOptix_si_wh, 1xLED 30W 840/4000K 3240lm)

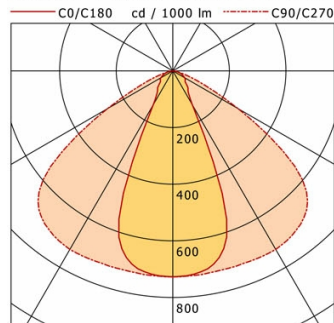

	C0	C90	C180	C270
0°	727	727	727	727
15°	667	724	667	724
30°	138	728	138	728
45°	69	673	69	673
60°	49	267	49	267
75°	23	33	23	33
90°	0	0	0	0
cd / 1000 lm				

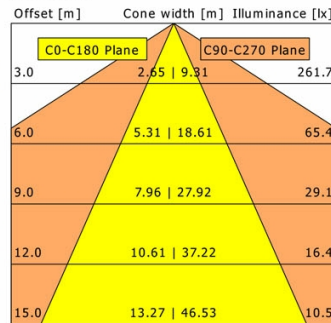

η	LED
Efficiency	108 lm/W
Direct/Indirect	↓ 100% / ↑ 0%
System Power	30 W
UGR	X=4H, Y=8H
Reflection factors	70/50/20
UGR C0/C180	19.0
UGR C90/C270	24.7
CIE Flux Codes	71 92 99 100 100
Ra/CRI	>80

LTS

STRL 610.1125.840/DALI

StraitLine | Light-Module (Batwing/Wide Beam nanoOptix_si_wh, 1xLED 30W 840/4000K 3520lm)

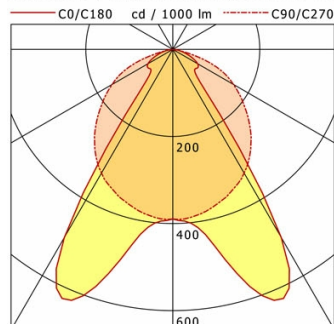

	C0	C90	C180	C270
0°	390	390	390	390
15°	516	372	516	372
30°	499	328	499	328
45°	71	251	71	251
60°	66	161	66	161
75°	25	46	25	46
90°	0	0	0	0
cd / 1000 lm				

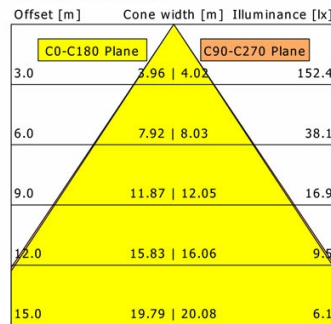

η	LED
Efficiency	117 lm/W
Direct/Indirect	↓ 100% / ↑ 0%
System Power	30 W
UGR	X=4H, Y=8H
Reflection factors	70/50/20
UGR C0/C180	20.9
UGR C90/C270	24.9
CIE Flux Codes	66 90 99 100 100
Ra/CRI	>80

LTS

STRL 610.1125.840/DALI

StraitLine | Light-Module (Opal Diffuse_bk, 1xLED 30W 840/4000K 2600lm)

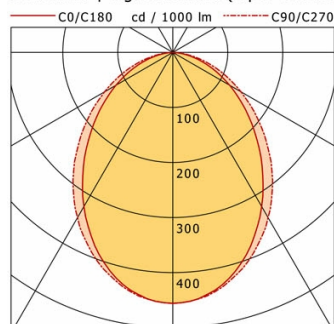

	C0	C90	C180	C270
0°	456	456	456	456
15°	418	424	418	424
30°	323	347	323	347
45°	213	245	213	245
60°	119	143	119	143
75°	45	57	45	57
90°	0	0	0	0
cd / 1000 lm				

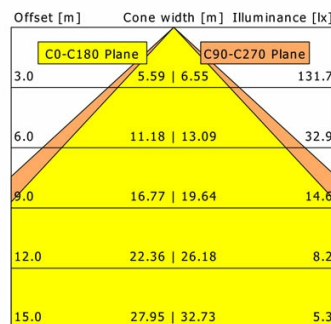

η	LED
Efficiency	87 lm/W
Direct/Indirect	↓ 100% / ↑ 0%
System Power	30 W
UGR	X=4H, Y=8H
Reflection factors	70/50/20
UGR C0/C180	23.8
UGR C90/C270	24.8
CIE Flux Codes	54 83 97 100 100
Ra/CRI	>80

LTS

STRL 610.1125.840/DALI

STRL 610.1125.840/DALI

StraitLine | Light-Module (Deep Beam nanoOptix_bk, 1xLED 30W 840/4000K 2780lm)

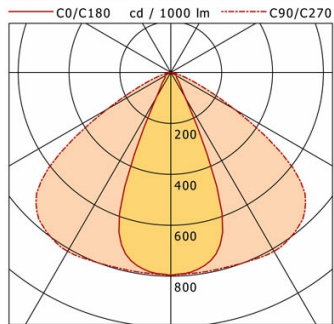

	C0	C90	C180	C270
0°	796	796	796	796
15°	721	795	721	795
30°	114	811	114	811
45°	35	748	35	748
60°	26	290	26	290
75°	10	33	10	33
90°	0	0	0	0

cd / 1000 lm

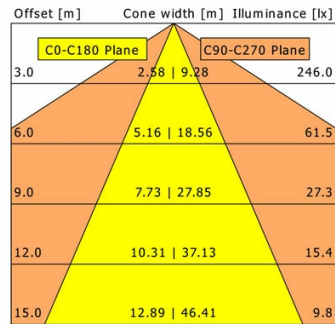

η	LED
Efficiency	93 lm/W
Direct/Indirect	↓ 100% / ↑ 0%
System Power	30 W
UGR	X=4H, Y=8H
Reflection factors	70/50/20
UGR C0/C180	13.8
UGR C90/C270	24.4
CIE Flux Codes	75 94 99 100 100
Ra/CRI	>80

LTS

STRL 610.1125.840/DALI

StraitLine | Light-Module (Batwing/Wide Beam nanoOptix_bk, 1xLED 30W 840/4000K 3040lm)

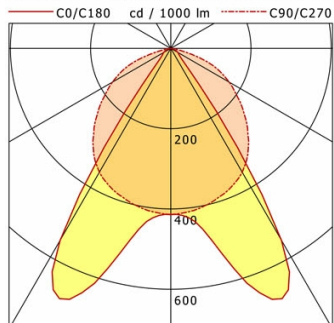

	C0	C90	C180	C270
0°	414	414	414	414
15°	548	396	548	396
30°	552	356	552	356
45°	41	269	41	269
60°	20	168	20	168
75°	8	46	8	46
90°	0	0	0	0

cd / 1000 lm

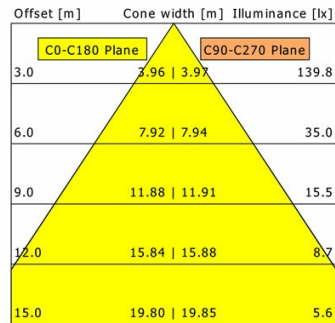

η	LED
Efficiency	101 lm/W
Direct/Indirect	↓ 100% / ↑ 0%
System Power	30 W
UGR	X=4H, Y=8H
Reflection factors	70/50/20
UGR C0/C180	16.5
UGR C90/C270	24.6
CIE Flux Codes	71 94 99 100 100
Ra/CRI	>80

LTS

STRL 610.1125.840/DALI

Zubehör



STRL-LK-Z070-060.102.00
Verbinder-Set linear



STRL-LK060-Z690.BW-WB.03
Lichtlenkungsfolie nanoOptix "Batwing und breitstrahlend"
(Länge: 3 m)



STRL-LK060-Z690.BW-WB.05
Lichtlenkungsfolie nanoOptix "Batwing und breitstrahlend"
(Länge: 5 m)



STRL-LK060-Z690.BW-WB.10
Lichtlenkungsfolie nanoOptix "Batwing und breitstrahlend"
(Länge: 10 m)



STRL-LK060-Z690.BW-WB.15
Lichtlenkungsfolie nanoOptix "Batwing und breitstrahlend"
(Länge: 15 m)



STRL-LK060-Z690.BW-WB.20
Lichtlenkungsfolie nanoOptix "Batwing und breitstrahlend"
(Länge: 20 m)



STRL-LK060-Z690.BW-WB.25
Lichtlenkungsfolie nanoOptix "Batwing und breitstrahlend"
(Länge: 25 m)



STRL-LK060-Z690.BW-WB.30
Lichtlenkungsfolie nanoOptix "Batwing und breitstrahlend"
(Länge: 30 m)



STRL-LK060-Z690.DB.03
Lichtlenkungsfolie nanoOptix "tiefstrahlend"
(Länge: 3 m)



STRL-LK060-Z690.DB.05
Lichtlenkungsfolie nanoOptix "tiefstrahlend"
(Länge: 5 m)



STRL-LK060-Z690.DB.10
Lichtlenkungsfolie nanoOptix "tiefstrahlend"
(Länge: 10 m)



STRL-LK060-Z690.DB.15
Lichtlenkungsfolie nanoOptix "tiefstrahlend"
(Länge: 15 m)



STRL-LK060-Z690.DB.20
Lichtlenkungsfolie nanoOptix "tiefstrahlend"
(Länge: 20 m)



STRL-LK060-Z690.DB.25
Lichtlenkungsfolie nanoOptix "tiefstrahlend"
(Länge: 25 m)



STRL-LK060-Z690.DB.30
Lichtlenkungsfolie nanoOptix "tiefstrahlend"
(Länge: 30 m)



STRL-LK060-Z690.OPDF.03
Lichtlenkungsfolie "opal diffus"
(Länge: 3 m)



STRL-LK060-Z690.OPDF.05
Lichtlenkungsfolie "opal diffus"
(Länge: 5 m)



STRL-LK060-Z690.OPDF.10
Lichtlenkungsfolie "opal diffus"
(Länge: 10 m)

STRL 610.1125.840/DALI

Zubehör



STRL-LK060-Z 690.OPDF.15
Lichtlenkungsfolie "opal diffus"
(Länge: 15 m)



STRL-LK060-Z 690.OPDF.20
Lichtlenkungsfolie "opal diffus"
(Länge: 20 m)



STRL-LK060-Z 690.OPDF.25
Lichtlenkungsfolie "opal diffus"
(Länge: 25 m)



STRL-LK060-Z 690.OPDF.30
Lichtlenkungsfolie "opal diffus"
(Länge: 30 m)



STRL-LKDI-Z 060.001
Enddeckel
(2 Stück)

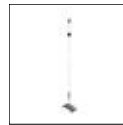

STRL-LKDI-Z 060.104.03
Drahtseil-Set ohne Einspeisung
(Länge: 3000 mm)

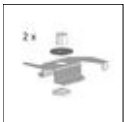

STRL-Z 104
Anbauklammern
(2 Stück)