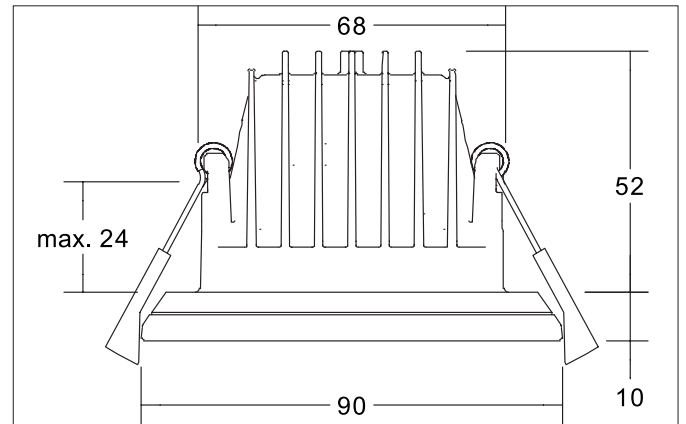

ZONDRA LED recessed downlight set, direct / indirect, trailing edge**phase dimmable**

Article no. 39338183

Light.
For Generations.**Tender**

LED recessed downlight set, direct / indirect, trailing edge phase dimmable, Round. Toolless ceiling installation by installation springs. Ceiling cut-out Ø 68 mm, Installation depth 52 mm, Outer diameter 90 mm, Weight 0,282 kg, Reflector silver with rotationssymmetrical, deep, wide distributed light intensity. optimal light distribution due to a plastic, structured cover. with max: 10 W, Delivery without bulb. Housing material: Aluminium / Plastic, Colour: White structure, Permissible ambient temperature (ta): -20 °C - +25 °C, Protection class (EN 61140): II, Degree of protection (DIN EN 60529): IP20. With electronic driver, Trailing-edge phase dimmable with integrated strain relief.

Article data	
Article no.	39338183
GTIN	4251433981527
Series name	ZONDRA
Short description	LED recessed downlight set, direct / indirect, trailing edge phase dimmable
Material	Aluminium / Plastic
Colour	White
Type of surface	Structure
Shape	Round
Outer diameter	90 mm
Built-in diameter	68 mm
Installation depth	52 mm
Height	10 mm
Weight	0.282 kg

**ZONDRA LED recessed downlight set, direct / indirect, trailing edge
phase dimmable**

Article no. 39338183

Light.
For Generations.

Lighting technology	
Colour temperature	3000 K
Light colour	White
Light output	Direct/Indirect
Luminous flux	660 lm
System efficiency	66 lm/W
Colour rendering	CRI > 80
Reflector	Matt
Reflektorfarbe	silver
Beam angle	24°
Light sharing	Symmetric

Operating technology of the luminaire	
System output	10 W
Voltage type	AC
AC nominal voltage max	230 V
Frequenz max.	50 Hz
Lamp	LED
Protection class	II
Degree of protection	IP20
Dimmable	Yes
Control	Trailing-edge phase
Bulb change possible	The light source of this luminaire may only be replaced by the manufacturer or a service technician commissioned by him or a similarly qualified person.

Mounting technology	
Mounting method	Recessed mounting
Place of installation	Ceiling-mounted
Adjustability	Not adjustable
Max. ceiling thickness	24 mm
Further references	No cover with thermal insulation material
Material cover	Plastic, structured
Circlip	Without circlip
Suitable for through-wiring	Yes, with optional accessories

Packing data	
Gross weight	0.339 kg
Length of packaging	140 mm
Packaging width	125 mm
Packaging height	85 mm
Disposal at end of life	This product must not be disposed of with household waste. You are obliged, to dispose of such electrical waste separately. By disposing of electrical waste and other old or defective electronics separately, you support recycling or other forms of re-use. In that way you help to take care and to avoid that harmful substances get into the environment.

Accessories	
-------------	--