

# FLIR 200.2027.50

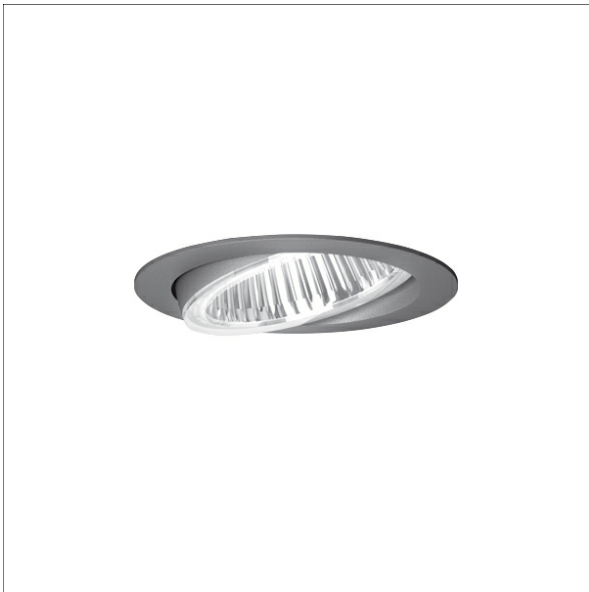

Farbe	Artikelnummer	EAN
schwarz	636613	4043544391957
silber	636614	4043544391964
weiß	636615	4043544391971

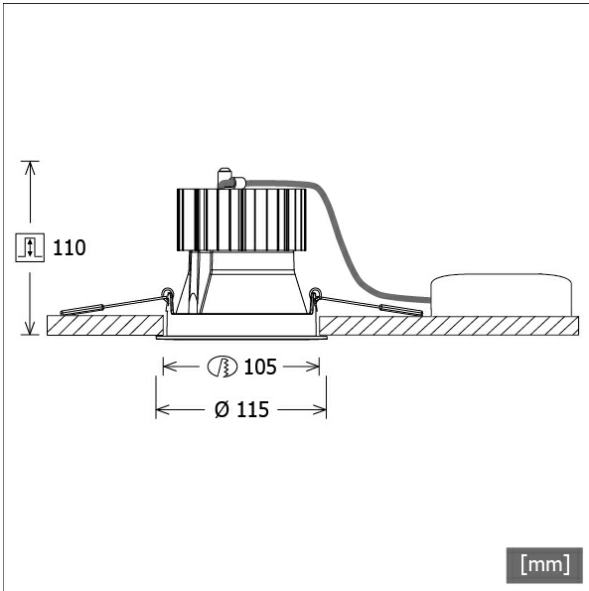

## Beschreibung

- Einbaustrahler mit optischen Designvarianten und breitem Anwendungsspektrum
- Lichtkopf 20° schwenkbar
- hohe Wartungsfreundlichkeit
- keine UV- und Wärmestrahlung
- Wärmemanagement mit Passivkühlung (Kühlkörper aus Aluminium)
- High-Performance Spiegelreflektor aus Aluminium mit präziser symmetrischer Abstrahlcharakteristik für maximale Lichtausbeute und optimale Entblendung
- Front-/Einbauring aus Zinkdruckguss mit Lichteffektring klar (weitere Dekor-/Lichteffektringe und Dekogläser sind als Option erhältlich)
- werkzeugloser Deckeneinbau mit Schnellspannfedern (automatische Anpassung der Deckenstärke)
- Anschluss an Betriebsgerät über Leuchtenkabel mit Mini-Clamp Steckverbindung
- Betriebsgerät (LED-Konverter) inklusive (Platzierung extern)

## Standardoptionen



## Sonderoptionen



## Lichttechnik / Normen

Leuchtmittel	LED Spot / CRI 80 / max. 2700 K
Lebensdauer	L90 B50 50.000 h L80 B50 100.000 h L80 B20 50.000 h
Systemleistung	27,0 W
Leuchten-Lichtstrom	max. 2740 lm
Systemeffizienz	101,48 lm/W
Moduleffizienz	157,68 lm/W
UGR 4H/8H 70/50/20	21,2/21,2 (C0/C90)
Abstrahlwinkel	50°
Versorgungsspannung	220 - 240 V / 50 Hz
Schutzklasse	III
Schutzart	IP20

## Abmessungen / Gewichte

Außendurchmesser	115 mm
Höhe	112 mm
Ausschnittsmaß (∅)	105 mm
Deckenstärke	1 - 25 mm
Einbautiefe	110 mm
Nettogewicht	0,87 kg
Bruttogewicht	0,95 kg

# FLIR 200.2027.50

## FLIR 200.2027.50

Flixx 200 Round (FLIRZ 200.05, 1xLED 27W 827/2700K 2740lm 50 °)

— C0/C180 cd / 1000 lm

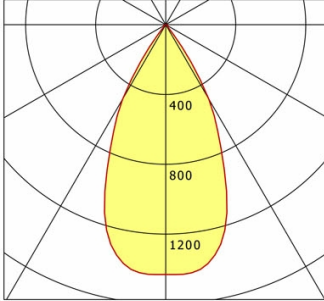

	C0	C90	C180	C270
0°	1431	1431	1431	1431
15°	1264	1264	1264	1264
30°	492	492	492	492
45°	17	17	17	17
60°	14	14	14	14
75°	6	6	6	6
90°	0	0	0	0
cd / 1000 lm				

Offset [m] Cone width [m] Illuminance [lx]

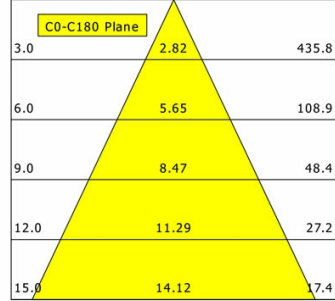

<b>η</b>	LED
Efficiency	102 lm/W
Direct/Indirect	↓ 100% / ↑ 0%
System Power	27 W
<b>UGR</b>	X=4H, Y=8H
Reflection factors	70/50/20
UGR C0/C180	21.2
UGR C90/C270	21.2
CIE Flux Codes	95 98 100 100 100
Ra/CRI	>80

LTS

## FLIR 200.2027.50

Flixx 200 Round (FLIRZ 200.25, 1xLED 27W 827/2700K 2660lm 50 °)

— C0/C180 cd / 1000 lm

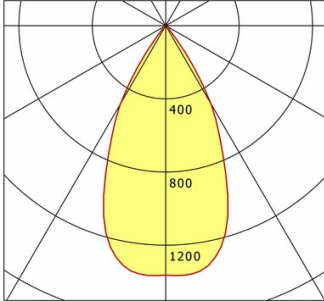

	C0	C90	C180	C270
0°	1364	1364	1364	1364
15°	1216	1216	1216	1216
30°	494	494	494	494
45°	27	27	27	27
60°	17	17	17	17
75°	6	6	6	6
90°	0	0	0	0
cd / 1000 lm				

Offset [m] Cone width [m] Illuminance [lx]

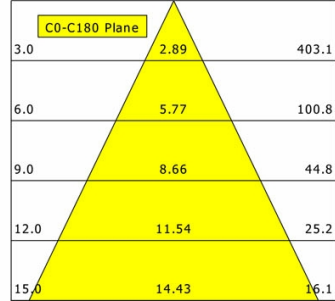

<b>η</b>	LED
Efficiency	99 lm/W
Direct/Indirect	↓ 100% / ↑ 0%
System Power	27 W
<b>UGR</b>	X=4H, Y=8H
Reflection factors	70/50/20
UGR C0/C180	21.5
UGR C90/C270	21.5
CIE Flux Codes	94 98 100 100 100
Ra/CRI	>80

LTS

## FLIR 200.2027.50

Flixx 200 Round (FLIRZ 200.24, 1xLED 27W 827/2700K 2580lm 50 °)

— C0/C180 cd / 1000 lm

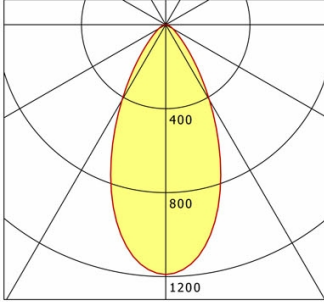

	C0	C90	C180	C270
0°	1190	1190	1190	1190
15°	936	936	936	936
30°	415	415	415	415
45°	116	116	116	116
60°	39	39	39	39
75°	16	16	16	16
90°	0	0	0	0
cd / 1000 lm				

Offset [m] Cone width [m] Illuminance [lx]

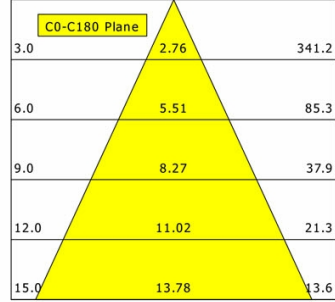

<b>η</b>	LED
Efficiency	96 lm/W
Direct/Indirect	↓ 100% / ↑ 0%
System Power	27 W
<b>UGR</b>	X=4H, Y=8H
Reflection factors	70/50/20
UGR C0/C180	26.2
UGR C90/C270	26.2
CIE Flux Codes	83 95 99 100 100
Ra/CRI	>80

LTS

# FLIRZ 200.2027.50

## Zubehör



**FLIRZ 200.01**  
Dekorring schwarz



**FLIRZ 200.02**  
Dekorring silber



**FLIRZ 200.03**  
Dekorring weiß



**FLIRZ 200.04**  
Lichteffektring opal



**FLIRZ 200.05**  
Lichteffektring klar



**FLIRZ 200.06**  
Lichteffektring rot matt



**FLIRZ 200.07**  
Lichteffektring gelb matt



**FLIRZ 200.08**  
Lichteffektring blau matt



**FLIRZ 200.16**  
Lichteffektring rot transluzent



**FLIRZ 200.17**  
Lichteffektring gelb transluzent



**FLIRZ 200.18**  
Lichteffektring blau transluzent

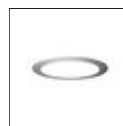

**FLIRZ 200.24**  
Dekoglas opal



**FLIRZ 200.25**  
Dekoglas klar