

# FLIQ 100.1040.01

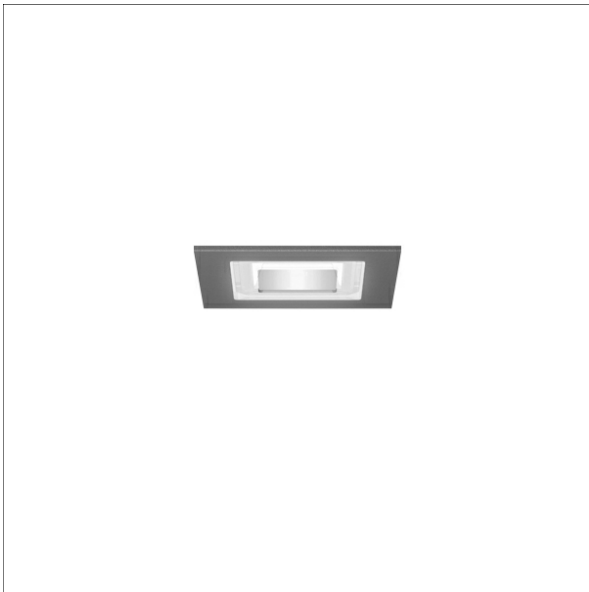

Farbe	Artikelnummer	EAN
schwarz	636414	4043544389947
silber	636415	4043544389954
weiß	636416	4043544389961

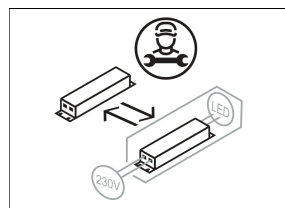
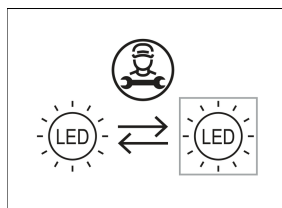
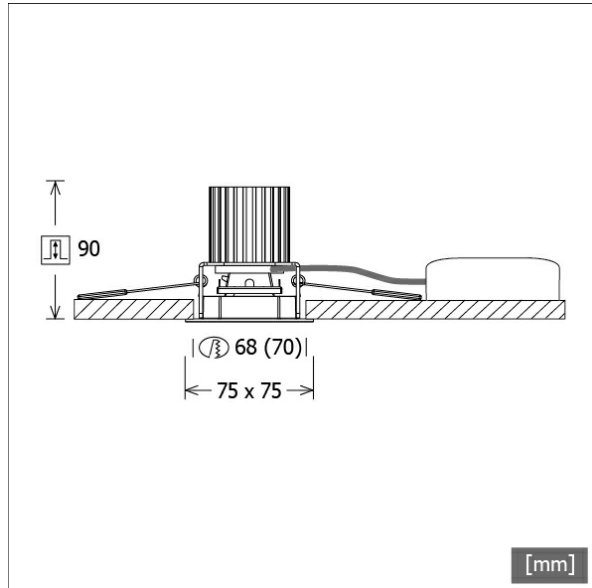

## Beschreibung

- Einbau-Downlight mit optischen Designvarianten für Allgemeinbeleuchtung
- hohe Wartungsfreundlichkeit
- keine UV- und Wärmestrahlung
- innovatives Wärmemanagement mit Passivkühlung (Kühlkörper aus Aluminium)
- entspiegelter Mattreflektor aus Aluminium für maximale Lichtausbeute und optimale Entblendung
- Front-/Einbaurahmen aus Zinkdruckguss mit Lichteffektrahmen klar (weitere Dekor-/Lichteffektrahmen und Dekogläser sind als Option erhältlich)
- werkzeugloser Deckeneinbau mit Schnellspannfedern (automatische Anpassung der Deckenstärke)
- Anschluss an Betriebsgerät über Leuchtenkabel mit Mini-Clamp Steckverbindung
- Betriebsgerät (LED-Konverter) inklusive (Platzierung extern)

## Hinweise

Das Aussägemeß = 68 mm gilt nur für Gipskartondecken. Für andere Deckenarten gilt das Aussägemeß = 70 mm.

## Standardoptionen

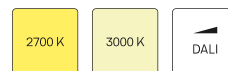

## Sonderoptionen



## Lichttechnik / Normen

Leuchtmittel	LED Spot / CRI 80 / max. 4000 K
Lebensdauer	L90 B50 50.000 h L80 B50 100.000 h L80 B20 50.000 h
Systemleistung	15,0 W
Leuchten-Lichtstrom	max. 1200 lm
Systemeffizienz	80,00 lm/W
Moduleffizienz	139,00 lm/W
UGR 4H/8H 70/50/20	29,7/29,9 (C0/C90)
Abstrahlwinkel	65°
Versorgungsspannung	220 - 240 V / 50 Hz
Schutzklasse	III
Schutzart	IP20

## Abmessungen / Gewichte

Länge	75 mm
Breite	75 mm
Höhe	92 mm
Ausschnittsmaß (∅)	68 mm
Deckenstärke	1 - 25 mm
Einbautiefe	90 mm
Nettogewicht	0,58 kg
Bruttogewicht	0,61 kg

# FLIQ 100.1040.01

## FLIQ 100.1040.01

Flixx 100 Square (FLIQZ 100.05, 1xLED 15W 840/4000K 1200lm 65 °)

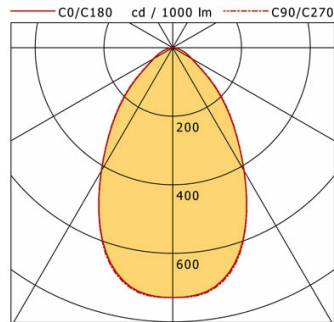

	C0	C90	C180	C270
0°	729	729	729	729
15°	666	670	666	670
30°	415	415	415	415
45°	193	199	193	199
60°	64	65	64	65
75°	23	24	23	24
90°	0	0	0	0
cd / 1000 lm				

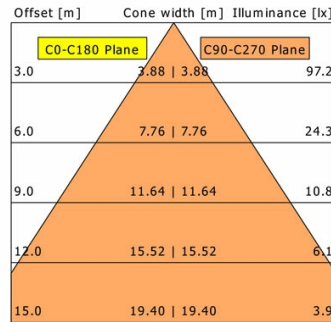

<b>η</b>	LED
Efficiency	80 lm/W
Direct/Indirect	↓ 100% / ↑ 0%
System Power	15 W
<b>UGR</b>	X=4H, Y=8H
Reflection factors	70/50/20
UGR C0/C180	29.7
UGR C90/C270	29.9
CIE Flux Codes	73 93 99 100 100
Ra/CRI	>80

LTS

## FLIQ 100.1040.01

Flixx 100 Square (FLIQZ 100.24, 1xLED 15W 840/4000K 1040lm 65 °)

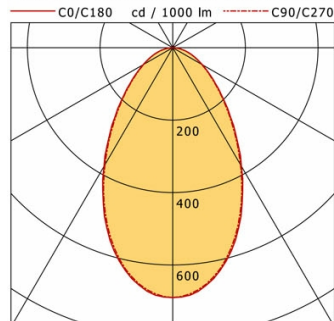

	C0	C90	C180	C270
0°	690	690	690	690
15°	596	591	596	591
30°	378	374	378	374
45°	194	191	194	191
60°	94	92	94	92
75°	39	37	39	37
90°	1	1	1	1
cd / 1000 lm				

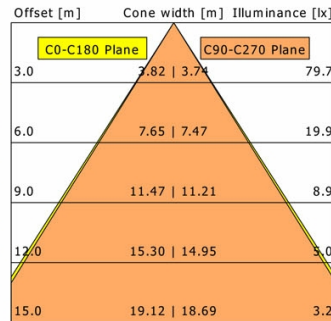

<b>η</b>	LED
Efficiency	69 lm/W
Direct/Indirect	↓ 100% / ↑ 0%
System Power	15 W
<b>UGR</b>	X=4H, Y=8H
Reflection factors	70/50/20
UGR C0/C180	31.7
UGR C90/C270	31.6
CIE Flux Codes	65 88 97 100 100
Ra/CRI	>80

LTS

## FLIQ 100.1040.01

Flixx 100 Square (FLIQZ 100.25, 1xLED 15W 840/4000K 1150lm 65 °)

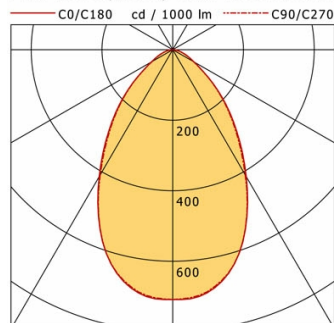

	C0	C90	C180	C270
0°	709	709	709	709
15°	643	642	643	642
30°	416	410	416	410
45°	205	201	205	201
60°	69	68	69	68
75°	24	24	24	24
90°	0	0	0	0
cd / 1000 lm				

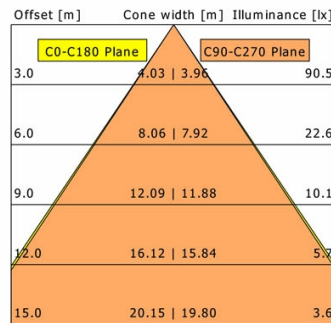

<b>η</b>	LED
Efficiency	77 lm/W
Direct/Indirect	↓ 100% / ↑ 0%
System Power	15 W
<b>UGR</b>	X=4H, Y=8H
Reflection factors	70/50/20
UGR C0/C180	29.9
UGR C90/C270	29.9
CIE Flux Codes	71 92 99 100 100
Ra/CRI	>80

LTS

# FLIQ 100.1040.01

## Zubehör



**FLIQ 100.01**  
Dekorrahmen schwarz



**FLIQ 100.02**  
Dekorrahmen silber



**FLIQ 100.03**  
Dekorrahmen weiß



**FLIQ 100.04**  
Lichteffektrahmen opal



**FLIQ 100.05**  
Lichteffektrahmen klar



**FLIQ 100.06**  
Lichteffektrahmen rot matt



**FLIQ 100.07**  
Lichteffektrahmen gelb matt



**FLIQ 100.08**  
Lichteffektrahmen blau matt



**FLIQ 100.16**  
Lichteffektrahmen rot transluzent



**FLIQ 100.17**  
Lichteffektrahmen gelb transluzent



**FLIQ 100.18**  
Lichteffektrahmen blau transluzent



**FLIQ 100.24**  
Dekoglas opal



**FLIQ 100.25**  
Dekoglas klar