

Wall mounting socket outlet - housing dimensions 80x70



Product description	
BALS-Prd.-Nr	4157
EAN	4024941041577
Product category	Wall mounting socket outlet, extra-low voltage
Current	32A
Number of poles	3p
Poles	3P
Position of earth contact	10 h
Voltage	20 up to 25 and 40 up to 50V
Frequency	direct current (DC)

Product description	
Protection degree	IP44
Colour code	gray RAL 7035
Colour of appliance	Hinged lid grey RAL 7035, Housing bottom grey RAL 7035, Housing top grey RAL 7035, Collar grey RAL 7035
Connection design	with screw terminal
Maximum conductor size	10,0 qmm
Cable entry	top entry M25
Height	113mm
Width	70mm
Depth	79mm
Dimension of enclosure	80x70 mm (HxW)
Material of enclosure	Polyamide
Contact	The contact carrier is made of polyamide, the contacts are brass nickel plated

Additional technical properties	
	The cable entry is one at top open

Logistics data	
Weight/pcs	0.2 kg / Piece
Packaging	Carton
Content amount	10 ST
EAN	4024941836531

Logistics data	
Length	245 mm
Width	177 mm
Height	185 mm
Weight	2.133 kg
Volume	7,140 ccm

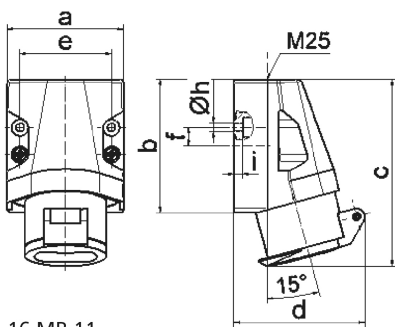

Ampere	16	16	32	32		
Polzahl	2	3	2	3		
a	70,0	70,0	70,0	70,0		
b	80,0	80,0	80,0	80,0		
c	113,0	113,0	113,0	113,0		
d	80,0	80,0	80,0	80,0		
e	55,0	55,0	55,0	55,0		
f	11,0	11,0	11,0	11,0		
h ø	5,2	5,2	5,2	5,2		
i	5,0	5,0	5,0	5,0		
Leiter mm ² min	4	4	4	4		
Leiter mm ² max	10	10	10	10		