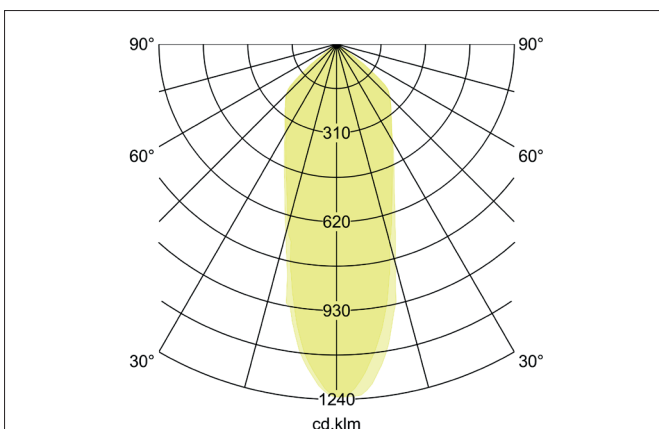
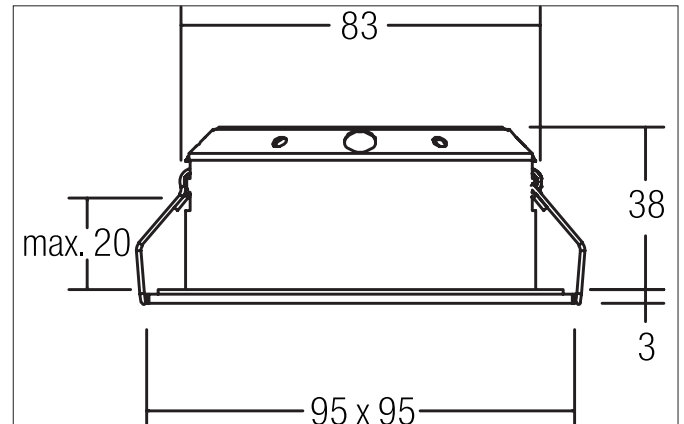

**INDIW083-S LED recessed spot, dim2warm**

Article no. 12486173

Light.  
For Generations.**Tender**

LED recessed spot, dim2warm, Square. Toolless ceiling installation by installation springs. Ceiling cut-out Ø 83 mm, Installation depth 38 mm, Length 95 mm, Width 95 mm, Weight 0,189 kg, Reflector silver with rotationssymmetrical, deep, wide distributed light intensity. optimal light distribution due to a plastic, transparent cover. Luminous flux 400 lm, Power 1 x 6 W, System Efficiency 67 lm/W, Light colour warm white to warm white, Correlated color temprature (CCT) 1.800 - 3.000 K, Colour rendering index CRI > 95, Housing material: Aluminium / Steel / PMMA, Colour: White structure, Permissible ambient temperature (ta): -20 °C - +25 °C, Protection class (EN 61140): III, Degree of protection (DIN EN 60529): IP20. For connection to an external driver, which is not included in the scope of delivery of the luminaire. Depending on driver dimmable.

**Product Benefits**

- Recessed spot in square design made of solid aluminum and protective cap for direct installation in thermal insulation material.
- Ceiling cutout 83 mm, length 95 mm, width 95 mm, installation depth 38 mm, luminous flux 400 lm, IP20.
- Version dim2warm (when the luminaire is dimmed, the color temperature is reduced to a minimum of 1,800 K).
- In the same surface structure and in the same colors also available in version 3.000 K and round.

**INDIWO83-S LED recessed spot, dim2warm**

Article no. 12486173

Light.  
For Generations.

Article data	
Article no.	12486173
GTIN	4251433916369
Series name	INDIWO83-S
Short description	LED recessed spot, dim2warm
Material	Aluminium / Steel / PMMA
Colour	White
Type of surface	Structure
Shape	Square
Built-in diameter	83 mm
Installation depth	38 mm
Length	95 mm
Width	95 mm
Height	3 mm
Weight	0.189 kg

Lighting technology	
Colour temperature	3.000 K - 1.800 K
Light colour	White
Light output	Direct
Luminous flux	400 lm
System efficiency	67 lm/W
Colour rendering	CRI > 95
Reflector	High-gloss
Reflektorfarbe	silver
Beam angle	36°
Light sharing	Symmetric

Operating technology of the luminaire	
Voltage type	DC
Current	350 mA
Lamp	LED
Lamp holder	Plug&Play
Protection class	III
Degree of protection	IP20
Dimmable	Depending on type of control gear
Control	Depending on driver
Bulb change possible	The light source of this luminaire may only be replaced by the manufacturer or a service technician commissioned by him or a similarly qualified person.











Mounting technology	
Mounting method	Recessed mounting
Place of installation	Ceiling-mounted
Adjustability	Pivoted
Swivel angle	25°
Max. ceiling thickness	20 mm
Material cover	Plastic, transparent

Packing data	
Gross weight	0.234 kg
Length of packaging	110 mm
Packaging width	110 mm
Packaging height	80 mm
Disposal at end of life	This product must not be disposed of with household waste. You are obliged, to dispose of such electrical waste separately. By disposing of electrical waste and other old or defective electronics separately, you support recycling or other forms of re-use. In that way you help to take care and to avoid that harmful substances get into the environment.

**INDIW083-S LED recessed spot, dim2warm**

Article no. 12486173

Light.  
For Generations.

Accessories	
	Article no.: 17663000 LED converter 350 mA, trailing-edge phase dimmable Power: 2,8 - 7 W Dimensions: 110 mm x 50 mm x 19 mm
	Article no.: 17663010 LED converter 350 mA, trailing-edge phase dimmable Power: 2,8 - 7 W Dimensions: 110 mm x 50 mm x 19 mm
	Article no.: 17663020 LED converter 350 mA, trailing-edge phase dimmable Power: 2,8 - 7 W Dimensions: 110 mm x 50 mm x 19 mm
	Article no.: 17652000 LED-round converter 350 mA, trailing-edge phase dimmer Power: 4,9 - 7 W Dimensions: 51 mm x 24 mm
	Article no.: 17652020 LED-round converter 350 mA, trailing-edge phase dimmer Power: 4,9 - 7 W Dimensions: 51 mm x 24 mm
	Article no.: 17640000 LED converter 350 mA, trailing-edge phase dimmable Power: 4,2 - 10 W Dimensions: 102 mm x 38 mm x 21 mm
	Article no.: 17640010 LED converter 350 mA, trailing-edge phase dimmable Power: 4,2 - 10 W Dimensions: 102 mm x 38 mm x 21 mm
	Article no.: 17640020 LED converter 350 mA, trailing-edge phase dimmable Power: 4,2 - 10 W Dimensions: 102 mm x 38 mm x 21 mm
	Article no.: 17657000 LED converter 350 mA, 1-10 V dimmable (analog) Power: 5,2 - 18 W Dimensions: 110 mm x 52 mm x 22 mm
	Article no.: 17657010 LED converter 350 mA, 1-10 V dimmable (analog) Power: 5,2 - 18 W Dimensions: 110 mm x 52 mm x 22 mm

**INDIW083-S LED recessed spot, dim2warm**

Article no. 12486173

Light.  
For Generations.

Accessories	
	Article no.: 17684000 LED converter 350 mA, DALI dimmable (digital) Power: 2,8 - 7 W Dimensions: 130 mm x 42 mm x 22 mm
	Article no.: 17684010 LED converter 350 mA, DALI dimmable (digital) Power: 2,8 - 7 W Dimensions: 130 mm x 42 mm x 22 mm
	Article no.: 17684020 LED converter 350 mA, DALI dimmable (digital) Power: 2,8 - 7 W Dimensions: 130 mm x 42 mm x 22 mm
	Article no.: 17658000 LED round converter 350 mA, DALI dimmable (digital) Power: 2,1 - 9 W Dimensions: 56 mm x 25 mm
	Article no.: 17658010 LED round converter 350 mA, DALI dimmable (digital) Power: 2,1 - 9 W Dimensions: 56 mm x 25 mm
	Article no.: 17658020 LED round converter 350 mA, DALI dimmable (digital) Power: 2,1 - 9 W Dimensions: 56 mm x 25 mm
	Article no.: 17683000 LED converter 350 mA, DALI dimmable (digital) Power: 3,5 - 17 W Dimensions: 110 mm x 52 mm x 22 mm
	Article no.: 17683010 LED converter 350 mA, DALI dimmable (digital) Power: 3,5 - 17 W Dimensions: 110 mm x 52 mm x 22 mm
	Article no.: 17683020 LED converter 350 mA, DALI dimmable (digital) Power: 3,5 - 17 W Dimensions: 110 mm x 52 mm x 22 mm
	Article no.: 17671000 LED converter 350mA, ZigBee dimmable Power: 3,5 - 18,5 W Dimensions: 146 mm x 44 mm x 30 mm
	Article no.: 17671010 LED converter 350mA, ZigBee dimmable Power: 3,5 - 18,5 W Dimensions: 146 mm x 44 mm x 30 mm

**INDIW083-S LED recessed spot, dim2warm**

Article no. 12486173

Light.  
For Generations.

Accessories	
	<p>Article no.: 17671020 LED converter 350mA, ZigBee dimmable Power: 3,5 - 18,5 W Dimensions: 146 mm x 44 mm x 30 mm</p>
	<p>Article no.: 17672000 LED converter 350mA, Casambi dimmable Power: 3,5 - 18 W Dimensions: 146 mm x 44 mm x 30 mm</p>
	<p>Article no.: 17672010 LED converter 350mA, Casambi dimmable Power: 3,5 - 18 W Dimensions: 146 mm x 44 mm x 30 mm</p>
	<p>Article no.: 17672020 LED converter 350mA, Casambi dimmable Power: 3,5 - 18 W Dimensions: 146 mm x 44 mm x 30 mm</p>
	<p>Article no.: 3835 Plug &amp; Play extension lead 350 mA Dimensions: 500 mm</p>
	<p>Article no.: 3836 Plug &amp; Play extension lead 350 mA Dimensions: 1,000 mm</p>
	<p>Article no.: 3837 Plug &amp; Play extension lead 350 mA Dimensions: 2,000 mm</p>