

FLIR 400.2030.01



Farbe	Artikelnummer	EAN
schwarz	636658	4043544392404
silber	636659	4043544392411
weiß	636660	4043544392428

Beschreibung

- Einbau-Downlight mit optischen Designvarianten für Allgemeinbeleuchtung
- hohe Wartungsfreundlichkeit
- keine UV- und Wärmestrahlung
- innovatives Wärmemanagement mit Passivkühlung (Kühlkörper aus Aluminiumdruckguss)
- High-Performance Spiegelreflektor aus Aluminium mit präziser symmetrischer Abstrahlcharakteristik für maximale Lichtausbeute und optimale Entblendung
- Front-/Einbauring aus Zinkdruckguss mit Lichteffektring klar (weitere Dekor-/Lichteffektringe und Dekogläser sind als Option erhältlich)
- werkzeugloser Deckeneinbau mit Schnellspannautomatik (automatische Anpassung der Deckenstärke)
- Anschluss an Betriebsgerät über vormontiertes Leuchtenkabel
- Betriebsgerät (LED-Konverter) inklusive (Platzierung extern)

Standardoptionen

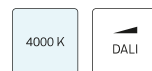

Sonderoptionen

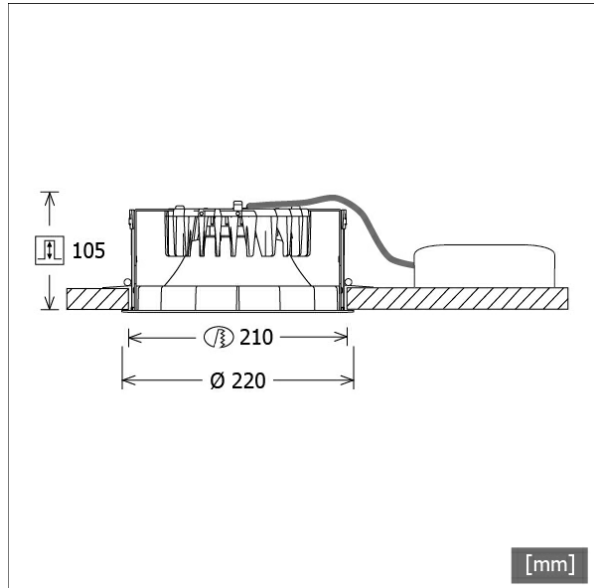

Lichttechnik / Normen

Leuchtmittel	LED Modul / CRI 80 / max. 3000 K
Lebensdauer	L90 B50 50.000 h L80 B50 100.000 h L80 B20 50.000 h
Systemleistung	21.0 W
Leuchten-Lichtstrom	max. 2170 lm
Systemeffizienz	99.04 lm/W
Moduleffizienz	130.00 lm/W
UGR 4H/8H 70/50/20	22.9/22.9 (C0/C90)
Abstrahlwinkel	75°
Versorgungsspannung	220 - 240 V / 50 Hz
Schutzklasse	III
Schutzart	IP20

Abmessungen / Gewichte

Außendurchmesser	220 mm
Höhe	107 mm
Ausschnittsmaß (∅)	210 mm
Deckenstärke	5 - 50 mm
Einbautiefe	105 mm
Nettogewicht	1.24 kg
Bruttogewicht	1.31 kg



FLIR 400.2030.01

FLIR 400.2030.01

Flixx 400 Round (FLIRZ 400.24, 1xLED 21W 830/3000K 2080lm 75 °)

— C0/C180 cd / 1000 lm

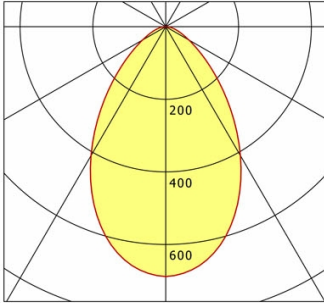

	C0	C90	C180	C270
0°	688	688	688	688
15°	610	610	610	610
30°	410	410	410	410
45°	197	197	197	197
60°	74	74	74	74
75°	26	26	26	26
90°	0	0	0	0
cd / 1000 lm				

Offset [m] Cone width [m] Illuminance [lx]

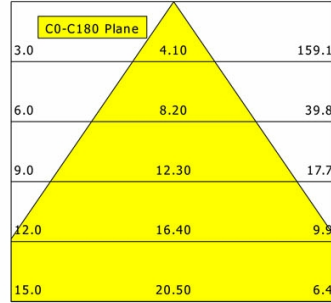

η	LED
Efficiency	99 lm/W
Direct/Indirect	↓ 100% / ↑ 0%
System Power	21 W
UGR	X=4H, Y=8H
Reflection factors	70/50/20
UGR C0/C180	22.9
UGR C90/C270	22.9
CIE Flux Codes	69 91 98 100 100
Ra/CRI	>80

LTS

FLIR 400.2030.01

Flixx 400 Round (FLIRZ 400.05, 1xLED 21W 830/3000K 2170lm 75 °)

— C0/C180 cd / 1000 lm

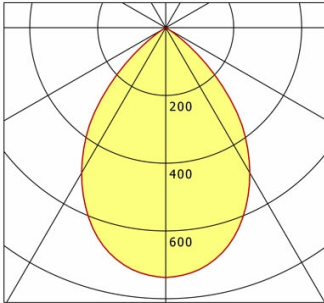

	C0	C90	C180	C270
0°	738	738	738	738
15°	677	677	677	677
30°	495	495	495	495
45°	221	221	221	221
60°	7	7	7	7
75°	4	4	4	4
90°	0	0	0	0
cd / 1000 lm				

Offset [m] Cone width [m] Illuminance [lx]

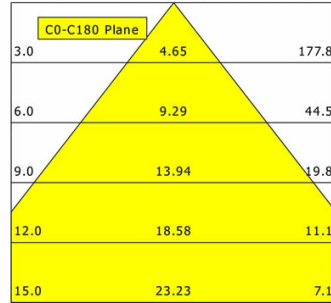

η	LED
Efficiency	103 lm/W
Direct/Indirect	↓ 100% / ↑ 0%
System Power	21 W
UGR	X=4H, Y=8H
Reflection factors	70/50/20
UGR C0/C180	19.6
UGR C90/C270	19.6
CIE Flux Codes	81 99 100 100 100
Ra/CRI	>80

LTS

FLIR 400.2030.01

Flixx 400 Round (FLIRZ 400.25, 1xLED 21W 830/3000K 2140lm 75 °)

— C0/C180 cd / 1000 lm

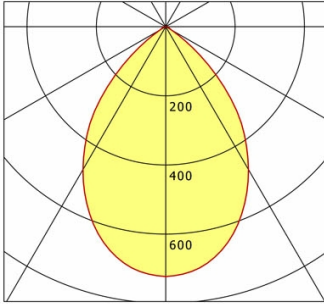

	C0	C90	C180	C270
0°	723	723	723	723
15°	658	658	658	658
30°	477	477	477	477
45°	223	223	223	223
60°	18	18	18	18
75°	8	8	8	8
90°	0	0	0	0
cd / 1000 lm				

Offset [m] Cone width [m] Illuminance [lx]

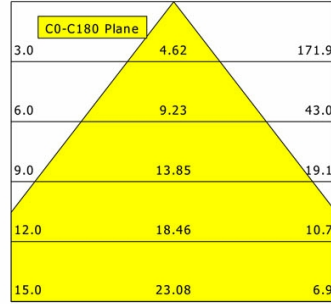

η	LED
Efficiency	102 lm/W
Direct/Indirect	↓ 100% / ↑ 0%
System Power	21 W
UGR	X=4H, Y=8H
Reflection factors	70/50/20
UGR C0/C180	19.9
UGR C90/C270	19.9
CIE Flux Codes	78 98 100 100 100
Ra/CRI	>80

LTS

FLIRZ 400.2030.01

Zubehör



FLIRZ 400.01
Dekorring schwarz



FLIRZ 400.02
Dekorring silber



FLIRZ 400.03
Dekorring weiß



FLIRZ 400.04
Lichteffektring opal



FLIRZ 400.05
Lichteffektring klar



FLIRZ 400.06
Lichteffektring rot matt



FLIRZ 400.07
Lichteffektring gelb matt



FLIRZ 400.08
Lichteffektring blau matt



FLIRZ 400.16
Lichteffektring rot transluzent



FLIRZ 400.17
Lichteffektring gelb transluzent



FLIRZ 400.18
Lichteffektring blau transluzent

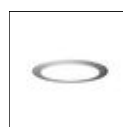

FLIRZ 400.24
Dekoglas opal



FLIRZ 400.25
Dekoglas klar



NOL 50B/3H/DALI
LED-Notlichteinheit



ZDAR 207.250-310
Ausgleichsring für Deckenausschnitte von 250 – 310 mm



ZVP 100
Universalverstärkungsrahmen
(Modul 625 x 625)