

Reduction ring 120 mm
Article no. 81004080

Light.
For Generations.

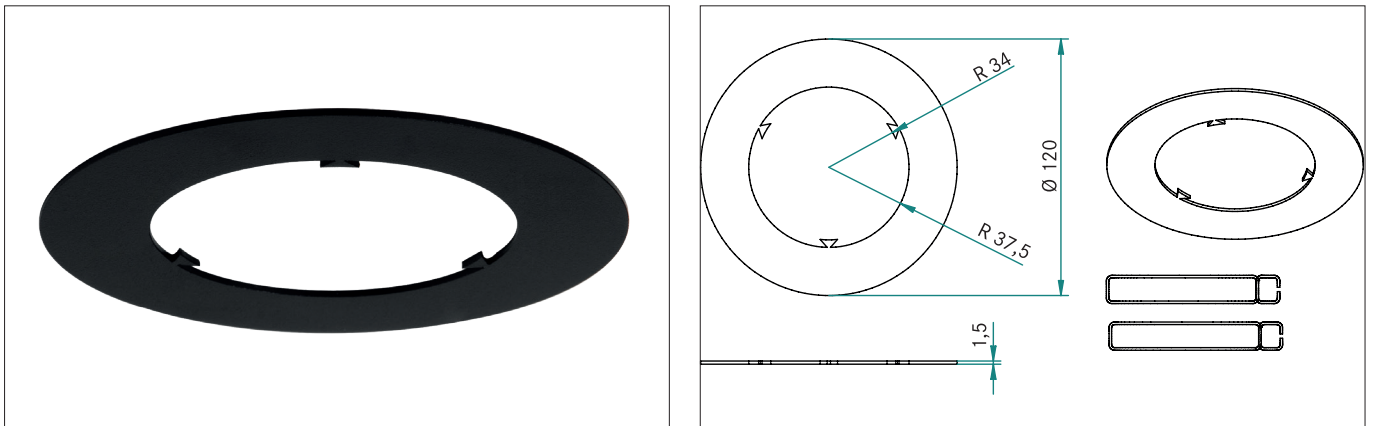

Tender

Reduction ring 120 mm, black, Round. Reduction ring is suitable for recessed spotlights with mounting springs. Outer diameter 120 mm (suitable for on-site ceiling cut-outs of up to 110 mm), inner diameter 68 or 74 mm (can be changed to 74 mm on the site), scope of delivery: 1 x reduction ring including 1 set of spring extension Material: Aluminium.

Article data	
Article no.	81004080
GTIN	4251433924913
Short description	Reduction ring 120 mm
Material	Aluminium
Colour	Black
Type of surface	Matt
Shape	Round
Outer diameter	120 mm
Hight	1.5 mm
Weight	0.034 kg

Packing data	
Gross weight	0.038 kg
Length of packaging	125 mm
Packaging width	125 mm
Packaging hight	10 mm
Disposal at end of life	This product must not be disposed of with household waste. You are obliged, to dispose of such electrical waste separately. By disposing of electrical waste and other old or defective electronics separately, you support recycling or other forms of re-use. In that way you help to take care and to avoid that harmful substances get into the environment.

Reduction ring 120 mm
Article no. 81004080

Light.
For Generations.