

GRK R 28/4 E



Kurzinformation

Radialgebläse aus Kunststoff mit rundem Ausblas, Baugröße 280, Wechselstrom, 4-Polig

Einsatzbeispiele

Industrieanwendung

Artikelnummer

0073.0508

Technische Daten

Fördervolumen	1.600 m ³ /h
Drehzahl	1.440 1/min
Lauftradtyp	radial
Drehzahlsteuerbar	–
Reversierbarkeit	–
Spannungsart	Wechselstrom
Bemessungsspannung	230 V
Netzfrequenz	50 Hz
Nennleistung	180 W
I _{Nenn}	1,6 A
Schutzart	IP 55
Wärmeklasse	F
Polumschaltbar	–
Einbauort	Rohranschluss
Einbaulage	horizontal
Material Gehäuse	Kunststoff, Polyethylen
Material Lauftrad	Kunststoff, Polyethylen
Farbe	hellgrau
Gewicht	33 kg
Gewicht mit Verpackung	56 kg
Breite	470 mm
Höhe	560 mm
Tiefe	515 mm
Breite mit Verpackung	1.200 mm
Höhe mit Verpackung	800 mm
Tiefe mit Verpackung	710 mm
Fördermitteltemperatur bei I _{Max}	-15 °C bis 70 °C
PTC DIN 44082	M 100
Verpackungseinheit	1 Stück

GRK R 28/4 E

Sortiment	C
GTIN (EAN)	4012799735083

Schallleistungspegel im Oktavspektrum

	63 Hz	125 Hz	250 Hz	500 Hz	1 kHz	2 kHz	4 kHz	8 kHz	Gesamt
L_{WA5, S5} (dB(A))	46,8	58,9	67,4	67,8	70	66,2	58	47,9	74

L_{WA5} = Freiansaug-Schallleistungspegel in dB

Kennlinie

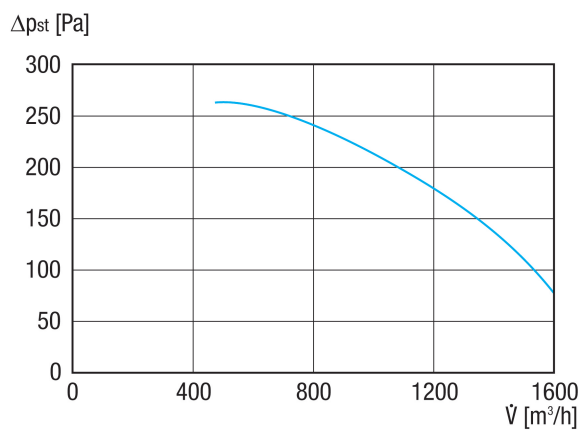

GRK R 28/4 E

Maßzeichnung [mm]

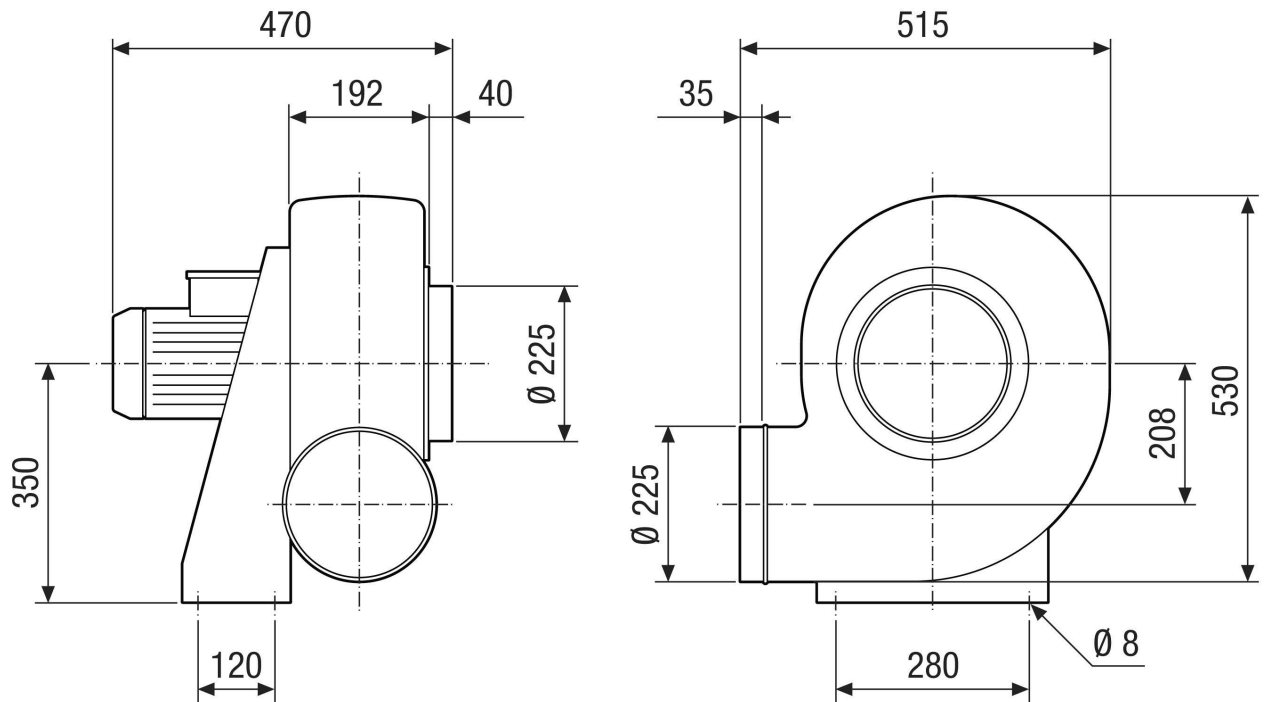

GRK R 28/4 E

Maßzeichnung Gehäuseausrichtung [mm]

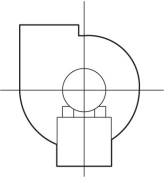
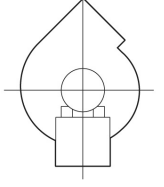
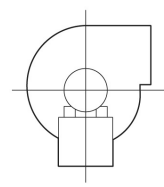
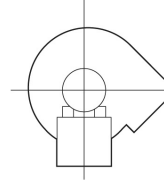
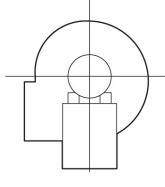
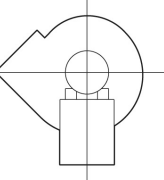
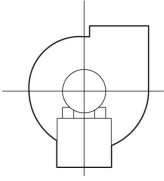
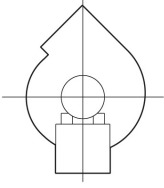
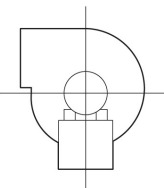
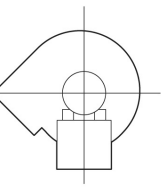
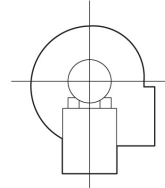
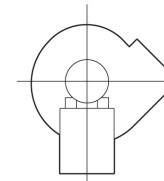
①						
	0°	45°	90°	135°	270°	315°
②						

- ① Rechtsausführung
- ② Linksausführung