

# Vision System FZ5-Series

## A range of processing items for positioning and inspection

- The High-precision Object Detection Required for Positioning
- Converting Measurement Results to Output User Units
- Easily Integrate Interfaces into the Machine
- Easy Setup with Program Scalability



## System configuration

### EtherNet/IP, No-protocol Ethernet and PLC Link Connections

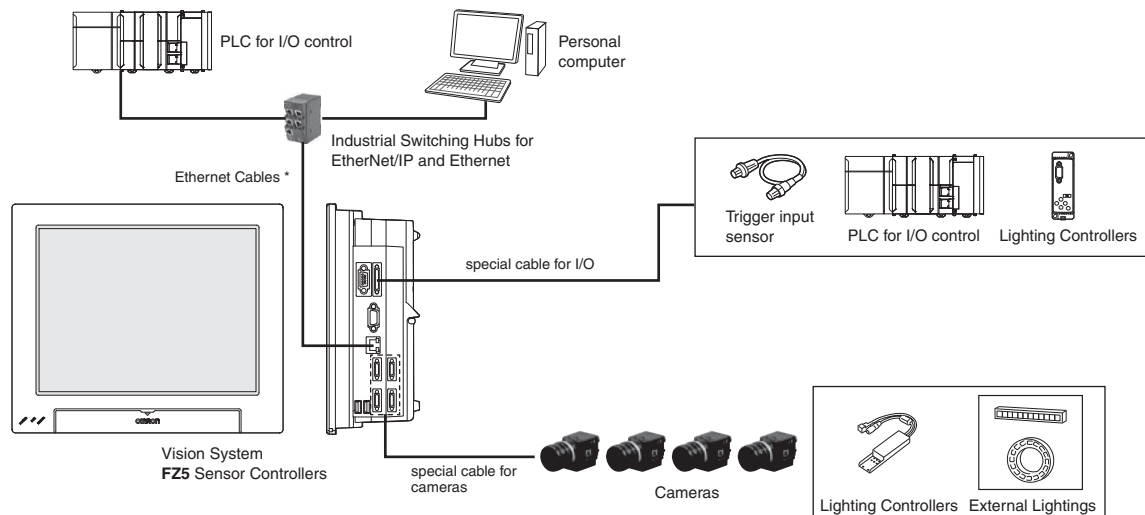

Example of the FZ5 Sensor Controllers (4-camera type)



\* To use Straight or cross STP (shielded twisted-pair) cable of category 5 or higher for Ethernet and RJ45 connector.

## Ordering Information

### FZ5 Series Sensor Controllers







Item	CPU	No. of cameras	Output	Model
 Controllers integrated with LCD	High-speed Controllers	2	NPN	FZ5-1200
			PNP	FZ5-1205
		4	NPN	FZ5-1200-10
			PNP	FZ5-1205-10
		2	NPN	FZ5-1100 *
			PNP	FZ5-1105 *
	4	NPN	FZ5-1100-10 *	
		PNP	FZ5-1105-10 *	
	Standard Controllers	2	NPN	FZ5-800
			PNP	FZ5-805
		4	NPN	FZ5-800-10
			PNP	FZ5-805-10
2		NPN	FZ5-600 *	
		PNP	FZ5-605 *	
4	NPN	FZ5-600-10 *		
	PNP	FZ5-605-10 *		
 Box-type controllers	Lite Controllers	2	NPN	FZ5-L350
			PNP	FZ5-L355
	4	NPN	FZ5-L350-10	
		PNP	FZ5-L355-10	

\* The production of the FZ5-series Controllers FZ5-1100(-10)/-1105(-10)/-600(-10)/-605(-10) were discontinued at the end of May 2018.

Company names and product names in this document are the trademarks or registered trademarks of their respective companies. The product photographs and figures that are used in this catalog may vary somewhat from the actual products.







# FZ5-Series

## Cameras

Item	Descriptions	Color / Monochrome	Image Acquisition Time	Model
	Digital CCD/CMOS Cameras (Lens required)	5 million pixels	38.2 ms	FZ-SC5M3 *
				FZ-S5M3 *
	Digital CCD/CMOS Cameras (Lens required)	2 million pixels	33.3 ms	FZ-SC2M
				FZ-S2M
	Digital CCD/CMOS Cameras (Lens required)	300,000 pixels	12.5 ms	FZ-SC
				FZ-S
	Small Digital CCD Cameras (Lenses for small camera required)	300,000-pixel flat type	12.5 ms	FZ-SFC
				FZ-SF
	Small Digital CCD Cameras (Lenses for small camera required)	300,000-pixel pen type	12.5 ms	FZ-SPC
				FZ-SP
	Intelligent Compact CMOS Cameras (Camera + Manual Focus Lens + High power Lighting)	Narrow view	16.7 ms	FZ-SQ10F
		Standard view		FZ-SQ050F
		Wide View (long-distance)		FZ-SQ100F
		Wide View (short-distance)		FZ-SQ100N

\* This camera cannot be used for FZ5-6□ or FZ5-L35□.

## Camera Cables

Item	Descriptions	Cable length *2	Model
	Camera Cable	2m	FZ-VS3 2M
		3m	FZ-VS3 3M
		5m	FZ-VS3 5M
		10m	FZ-VS3 10M
	Bend resistant Camera Cable	2m	FZ-VSB3 2M
		3m	FZ-VSB3 3M
		5m	FZ-VSB3 5M
		10m	FZ-VSB3 10M
	Right-angle Camera Cable *1	2m	FZ-VSL3 2M
		3m	FZ-VSL3 3M
		5m	FZ-VSL3 5M
		10m	FZ-VSL3 10M
	Bend resistant Right-angle Camera Cable *1	2m	FZ-VSLB3 2M
		3m	FZ-VSLB3 3M
		5m	FZ-VSLB3 5M
		10m	FZ-VSLB3 10M
	Long-distance Camera Cable	15m	FZ-VS4 15M
	Long-distance Right-angle Camera Cable *1	15m	FZ-VSL4 15M
	Cable Extension Unit Up to two Extension Units and three Cables can be connected. (Maximum cable length: 45 m *2)	-	FZ-VSJ

\*1 This Cable has an L-shaped connector on the Camera end.

\*2 The maximum cable length depends on the Camera being connected, and the model and length of the Cable being used. For further information, please refer to the "Cameras / Cables Connection Table" and "Maximum Extension Length Using Cable Extension Units FZ-VSJ".

## Cameras / Cables Connection Table

Type of camera	Model	Cable length	Digital CCD/CMOS cameras			Small digital CCD cameras Pen type / flat type	Intelligent compact CMOS cameras
			300,000-pixel	2 million-pixel	5 million-pixel		
			FZ-S/SC	FZ-S2M/SC2M	FZ-S5M3/SC5M3/S5M2	FZ-SF/SFC FZ-SP/SPC	FZ-SQ□
Camera Cables Right-angle camera cables	FZ-VS3 FZ-VSL3	2 m	Yes	Yes	Yes	Yes	Yes
		3 m	Yes	Yes	Yes	Yes	Yes
		5 m	Yes	Yes	Yes	Yes	Yes
		10 m	Yes	Yes	No	Yes	Yes
Bend resistant camera cables Bend resistant Right-angle Camera Cable	FZ-VSB3 FZ-VSLB3	2 m	Yes	Yes	Yes	Yes	Yes
		3 m	Yes	Yes	Yes	Yes	Yes
		5 m	Yes	Yes	Yes	Yes	Yes
		10 m	Yes	Yes	No	Yes	Yes
Long-distance camera cable Long-distance right-angle camera cable	FZ-VS4 FZ-VSL4	15 m	Yes	Yes	No	Yes	Yes



## Maximum Extension Length Using Cable Extension Units FZ-VSJ

Item	Model	Maximum cable length using 1 Camera Cable	Max. number of connectable Extension Units	Using Cable Extension Units FZ-VSJ	
				Max. cable length	Connection configuration
Digital CCD/CMOS Cameras	FZ-S/SC FZ-S2M/SC2M	15 m (Using FZ-VS4/VSL4)	2	45 m	Camera cable: 15 m × 3 Extension Unit: 2
	FZ-S5M3/SC5M3	5 m (Using FZ-VS□/VSL□)	2	15 m	Camera cable: 5 m × 3 Extension Unit: 2
Small Digital CCD Cameras Flat type/ Pen type	FZ-SF/SFC FZ-SP/SPC	15 m (Using FZ-VS4/VSL4)	2	45 m	Camera cable: 15 m × 3 Extension Unit: 2
Intelligent Compact CMOS Cameras	FZ-SQ□	15 m (Using FZ-VS4/VSL4)	2	45 m	Camera cable: 15 m × 3 Extension Unit: 2

## LED Monitor Cable

Item	Descriptions	Cable length	Model
	LED Monitor Cable	2 m	FZ-VM 2M
		5 m	FZ-VM 5M

## Parallel I/O Cable

Item	Descriptions	Cable length	Model
	Parallel I/O Cable	2 m	FZ-VP 2M
		5 m	FZ-VP 5M
	Parallel I/O Cable for Connector-terminal Conversion Unit Connector-Terminal Block Conversion Units can be connected (Terminal Blocks Recommended Products: OMRON XW2R-□50GD-T*)	2 m	FZ-VPX 2M
		5 m	FZ-VPX 5M
	Connector-Terminal Block Conversion Units, General-purpose devices		XW2R-□50GD-T*

\* Insert the wiring method into □ in the model number as follows. Phillips screw = J, Slotted screw (rise up) = E, Push-in spring = P  
Refer to the XW2R Series catalog (Cat. No. G077) for details.

## Recommended EtherNet/IP Communications Cables

Use Straight or cross STP (shielded twisted-pair) cable of category 5 or higher for EtherNet/IP.

Item	Descriptions		Model
—	Wire Gauge and Number of Pairs: AWG24, 4-pair Cable	Cables	Hitachi Metals, Ltd. <b>NETSTAR-C5E SAB 0.5 × 4P CP *1</b>
—			Kuramo Electric Co. <b>KETH-SB *1</b>
—		RJ45 Connectors	Panduit Corporation <b>MPS588-C *1</b>
—		Cables	Kuramo Electric Co. <b>KETH-PSB-OMR *2</b>
—	Wire Gauge and Number of Pairs: AWG22, 2-pair Cable	JMACS Japan Co.,Ltd.	<b>PNET/B *2</b>
		RJ45 Assembly Connector	OMRON <b>XS6G-T421-1 *2</b>













**Note:** Please be careful while cable processing for EtherNet/IP, connectors on only one end should be shield connected.

\*1 We recommend you to use above cable For EtherNet/IP and RJ45 Connector together.

\*2 We recommend you to use above cable For EtherNet/IP and RJ45 Assembly Connector together.

# FZ5-Series

## Accessories

Item	Descriptions				Model
	LCD Monitor 8.4 inches For Box-type Controllers				FZ-M08
	USB Memory		2 GB		FZ-MEM2G
			8 GB		FZ-MEM8G
	VESA Attachment For installing the LCD integrated-type controller				FZ-VESA
	Desktop Controller Stand For installing the LCD integrated-type controller				FZ-DS
	Display/USB Switcher				FZ-DU
—	Mouse Recommended Products Driverless wired mouse (A mouse that requires the mouse driver to be installed is not supported.)				—
	Industrial Switching Hubs for EtherNet/IP and Ethernet	3 port	Failure detection: None	Current consumption: 0.22 A	W4S1-03B
		5 port	Failure detection: None	Current consumption: 0.22 A	W4S1-05B
		5 port	Failure detection: Supported		W4S1-05C
—	External Lighting		—		FLV Series * FL Series *
	Lighting Controller (Required to control external lighting from a Controller)	For FLV-Series	Camera Mount Lighting Controller		FLV-TCC Series *
			Analog Lighting Controller		FLV-ATC Series *
		For FL-Series	Camera Mount Lighting Controller		FL-TCC Series *
	For Intelligent Compact Camera	Mounting Bracket		FQ-XL	
		Mounting Brackets		FQ-XL2	
		Polarizing Filter Attachment		FQ-XF1	
—	Mounting Bracket for FZ-S□				FZ-S-XLC
	Mounting Bracket for FZ-S□2M				FZ-S2M-XLC
	Mounting Bracket for FH-S□, FZ-S□5M□				FH-SM-XLC

\* Refer to the Vision Accessory Catalog (Cat. No. Q198) for details.

## Lenses

Refer to the *Vision Accessory Catalog* (Cat. No. Q198) for details.

Resolution	Camera Model	Size of image element	Recommended lens		
			Standard Lens	Telecentric Lens	Vibrations and Shocks Resistant Lens
300,000-pixel	FZ-SF/SFC	1/3" equivalent	FZ-LES Series	---	---
	FZ-SP/SPC				
	FZ-S/SC		SV-V Series		
2 million-pixel	FZ-S2M/SC2M	1/1.8" equivalent	SV-H Series	VS-TCH Series	VS-MCA Series Non-telecentric Macro VS-MC Series
			VS-H1 Series		
5 million-pixel	FZ-S5M3/SC5M3	2/3" equivalent	SV-H Series	VS-TCH Series	VS-MCA Series Non-telecentric Macro VS-MC Series

# Ratings and Specifications (FZ5 Sensor Controllers)

Type		High-speed Controllers				Standard Controllers				Lite Controllers			
Model	NPN	FZ5-1200	FZ5-1200-10	FZ5-1100	FZ5-1100-10	FZ5-800	FZ5-800-10	FZ5-600	FZ5-600-10	FZ5-L350	FZ5-L350-10		
	PNP	FZ5-1205	FZ5-1205-10	FZ5-1105	FZ5-1105-10	FZ5-805	FZ5-805-10	FZ5-605	FZ5-605-10	FZ5-L355	FZ5-L355-10		
Controller type		Controllers integrated with LCD									Box-type controllers		
No. of Cameras		2	4	2	4	2	4	2	4	2	4		
Connected Camera		Can be connected to FZ-S series.						Can be connected to FZ-S series. (Can not be connected to FZ-SC5M3/-S5M3.)					
Processing resolution	When connected to an intelligent compact camera	752 (H) × 480 (V)											
	When connected to a 300,000-pixel camera	640 (H) × 480 (V)											
	When connected to a 2 million-pixel camera	1600 (H) × 1200 (V)											
	When connected to a 5 million-pixel camera	2448 (H) × 2044 (V)											
No. of scenes		128 *1						128					
Number of logged images *2	When connected to an intelligent compact camera	Connected to 1 camera	232						214				
		Connected to 2 cameras	116						107				
		Connected to 3 cameras	77						71				
		Connected to 4 cameras	58						53				
	When connected to a 300,000-pixel camera	Connected to 1 camera	Color camera: 270, Monochrome Camera: 272						Color camera: 250, Monochrome Camera: 252				
		Connected to 2 cameras	Color camera: 135, Monochrome Camera: 136						Color camera: 125, Monochrome Camera: 126				
		Connected to 3 cameras	Color camera: 90, Monochrome Camera: 90						Color camera: 83, Monochrome Camera: 84				
		Connected to 4 cameras	Color camera: 67, Monochrome Camera: 68						Color camera: 62, Monochrome Camera: 63				
	When connected to a 2 million-pixel camera	Connected to 1 camera	Color camera: 43, Monochrome Camera: 43						Color camera: 40, Monochrome Camera: 40				
		Connected to 2 cameras	Color camera: 21, Monochrome Camera: 21						Color camera: 20, Monochrome Camera: 20				
		Connected to 3 cameras	Color camera: 14, Monochrome Camera: 14						Color camera: 13, Monochrome Camera: 13				
		Connected to 4 cameras	Color camera: 10, Monochrome Camera: 10						Color camera: 10, Monochrome Camera: 10				
	When connected to a 5 million-pixel camera	Connected to 1 camera	Color camera: 16, Monochrome Camera: 16						Color camera: 11, Monochrome Camera: 11				
		Connected to 2 cameras	Color camera: 8, Monochrome Camera: 8						Color camera: 5, Monochrome Camera: 5				
		Connected to 3 cameras	Color camera: 5, Monochrome Camera: 5						-				
		Connected to 4 cameras	Color camera: 4, Monochrome Camera: 4						-				
Operation		Touch pen, mouse, etc.									Mouse or similar device		
Settings		Create series of processing steps by editing the flowchart (Help messages provided).											
Language		Japanese, English, Chinese (simplified), Chinese (Traditional), Korean, German, French, Italian, Spanish						Japanese, English, Chinese (simplified), Chinese (Traditional)					
Serial communications		RS-232C/422: 1 CH									RS-232: 1CH		
EtherNet communications		Ethernet 1000BASE-T		Ethernet 100BASE-TX/10BASE-T		Ethernet 1000BASE-T		Ethernet 100BASE-TX/10BASE-T		Ethernet 1000BASE-T			
EtherNet/IP communications		Ethernet port baud rate: 100 Mbps (100Base-TX)											
Parallel I/O		(When used in Multi-line random-trigger mode) • 17 inputs (RESET, STEP0/ENCTRIG_Z0, STEP1/ENCTRIG_Z1, DSA0 to 1, ENCTRIG_A0 to 1, ENCTRIG_B0 to 1, DI0 to 7). • 29 outputs (RUN/BUSY1, BUSY0, GATE0 to 1, OR0 to 1, READY0 to 1, ERROR, STGOUT0 to 3, DO0 to 15) (When used in other mode) • 13 inputs (RESET, STEP0/ENCTRIG_Z0, DSA0, ENCTRIG_A0, ENCTRIG_B0, DI0 to 7). • 26 outputs (RUN, BUSY0, GATE0, OR0, READY0, ERROR, STGOUT0 to 3, DO0 to 15) * STGOUT 2 to 3 only for camera 4 ch type						• 13 inputs (RESET, STEP0/ENCTRIG_Z0, DSA0, ENCTRIG_A0, ENCTRIG_B0, DI0 to 7). • 26 outputs (RUN, BUSY0, GATE0, OR0, READY0, ERROR, STGOUT0 to 3, DO0 to 15) * STGOUT 2 to 3 only for camera 4 ch type		• 11 inputs (RESET, STEP, DSA, and DI 0 to 7). • 26 outputs (RUN, BUSY, GATE, OR, READY, ERROR, STGOUT 0 to 3, and DO 0 to 15) * STGOUT 2 to 3 only for camera 4 ch type			
Monitor interface		Integrated Controller and LCD 12.1 inch TFT color LCD (Resolution: XGA 1,024 × 768 dots)									Analog RGB video output, 1 channel (Resolution: XGA 1,024 × 768 dots)		
USB interface		4 channels (supports USB 1.1 and 2.0)									2CH (supports USB1.1/2.0)		
Power supply voltage *3		20.4 to 26.4 VDC											
Current consumption (at 24.0 VDC) *4	When connected to an intelligent compact camera	5.0 A max.	7.5 A max.	5.0 A max.	7.5 A max.	5.0 A max.	7.5 A max.	5.0 A max.	7.5 A max.	4.0 A max.	5.5 A max.		
	When connected to a 300,000-pixel camera												
	When connected to a 2 million-pixel camera	3.7 A max.	4.9 A max.	3.7 A max.	4.9 A max.	3.7 A max.	4.9 A max.	3.7 A max.	4.9 A max.	2.6 A max.	2.9 A max.		
	When connected to a 5 million-pixel camera												
Ambient temperature range		Operating: 0 to 45 °C for low cooling fan speeds, 0 to 50 °C for high cooling fan speeds Storage: -20 to 65 °C (with no icing or condensation)									Operating: 0 to 45 °C, 0 to 50 °C Storage: -20 to 65 °C (with no icing or condensation)		
Ambient humidity range		Operating and storage: 35% to 85% (with no condensation)											
Weight		Approx. 3.2 kg	Approx. 3.4 kg	Approx. 3.2 kg	Approx. 3.4 kg	Approx. 3.2 kg	Approx. 3.4 kg	Approx. 3.2 kg	Approx. 3.4 kg	Approx. 1.8 kg			
Accessories		Touch pen (one, inside the front panel), Instruction Manual, 6 mounting brackets									Instruction Manual		

\*1 This can be increased up to 1024 using the Scene group conversion tool.

\*2 The image logging capacity changes when multiple cameras of different types are connected at the same time.

\*3 Do not ground the positive terminal of the 24-VDC power supply to a Lite Controller.

If the positive terminal is grounded, electrical shock may occur when an SG (0-V) part, such as the case of the Controller or Camera, is touched.

\*4 The current consumption when the maximum number of cameras supported by each controller are connected.

If a lighting controller model is connected to a lamp, the current consumption is as high as when an intelligent compact camera is connected.

## FZ5-Series

### Ratings and Specifications (Cameras)

#### Digital CCD/CMOS Cameras

Model	FZ-S	FZ-SC	FZ-S2M	FZ-SC2M	FZ-S5M3	FZ-SC5M3
Image elements	Interline transfer reading all pixels, CCD image elements (1/3-inch equivalent)		Interline transfer reading all pixels, CCD image elements (1/1.8-inch equivalent)		CMOS image elements (2/3-inch equivalent)	
Color/Monochrome	Monochrome	Color	Monochrome	Color	Monochrome	Color
Effective pixels	640 (H) × 480 (V)		1600 (H) × 1200 (V)		2448 (H) × 2048 (V)	
Imaging area H x V (opposing corner)	4.8 × 3.6 (6.0mm)		7.1 × 5.4 (8.9mm)		8.4 × 7.1 (11mm)	
Pixel size	7.4 (μm) × 7.4 (μm)		4.4 (μm) × 4.4 (μm)		3.45 (μm) × 3.45 (μm)	
Shutter function	Electronic shutter; select shutter speeds from 20 μs to 100 ms					
Partial function	12 to 480 lines		12 to 1200 lines		4 to 2048 lines	
Frame rate (Image Acquisition Time)	80 fps (12.5 ms)		30 fps (33.3 ms)		25.6 fps (38.2 ms)	
Lens mounting	C mount					
Field of vision, installation distance	Selecting a lens according to the field of vision and installation distance					
Ambient temperature range	Operating: 0 to 50 °C Storage: -25 to 65 °C (with no icing or condensation)		Operating: 0 to 40 °C Storage: -25 to 65 °C (with no icing or condensation)			
Ambient humidity range	Operating and storage: 35% to 85% (with no condensation)					
Weight	Approx. 55 g		Approx. 76 g		Approx. 85 g	
Accessories	Instruction manual					

#### Small CCD Digital Cameras

Model	FZ-SF	FZ-SFC	FZ-SP	FZ-SPC
Image elements	Interline transfer reading all pixels, CCD image elements (1/3-inch equivalent)			
Color/Monochrome	Monochrome	Color	Monochrome	Color
Effective pixels	640 (H) × 480 (V)			
Imaging area H x V (opposing corner)	4.8 × 3.6 (6.0mm)			
Pixel size	7.4 (μm) × 7.4 (μm)			
Shutter function	Electronic shutter; select shutter speeds from 20 μm to 100 ms			
Partial function	12 to 480 lines			
Frame rate (Image Acquisition Time)	80 fps (12.5ms)			
Lens mounting	Special mount (M10.5 P0.5)			
Field of vision, installation distance	Selecting a lens according to the field of vision and installation distance			
Ambient temperature range	Operating: 0 to 50 °C (camera amp) 0 to 45 °C (camera head) Storage: -25 to 65 °C (with no icing or condensation)			
Ambient humidity range	Operating and storage: 35% to 85% (with no condensation)			
Weight	Approx. 150 g			
Accessories	Instruction manual, installation bracket, Four mounting brackets (M2)		Instruction manual	

## Intelligent Compact CMOS Cameras

Model	FZ-SQ010F	FZ-SQ050F	FZ-SQ100F	FZ-SQ100N
Image elements	CMOS color image elements (1/3-inch equivalent)			
Color/Monochrome	Color			
Effective pixels	752 (H) × 480 (V)			
Imaging area H x V (opposing corner)	4.51 × 2.88 (5.35mm)			
Pixel size	6.0 (μm) × 6.0 (μm)			
Shutter function	1/250 to 1/32,258			
Partial function	8 to 480 lines			
Frame rate (Image Acquisition Time)	60 fps (16.7 ms)			
Field of vision	7.5 × 4.7 to 13 × 8.2 mm	13 × 8.2 to 53 × 33 mm	53 × 33 to 240 × 153 mm	29 × 18 to 300 × 191 mm
Installation distance	38 to 60 mm	56 to 215 mm	220 to 970 mm	32 to 380 mm
LED class *	Risk Group2			
Ambient temperature range	Operating: 0 to 50 °C Storage: -25 to 65 °C			
Ambient humidity range	Operating and storage: 35% to 85% (with no condensation)			
Weight	Approx. 150 g		Approx. 140 g	
Accessories	Mounting bracket (FQ-XL), polarizing filter attachment (FQ-XF1), instruction manual and warning label			

\* Applicable standards: IEC62471-2

### • Narrow View FZ-SQ010F

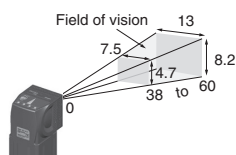

### • Standard FZ-SQ050F

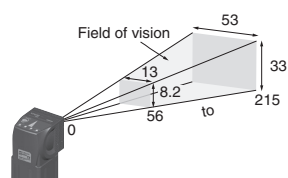

### • Wide View (Long-distance) FZ-SQ100F

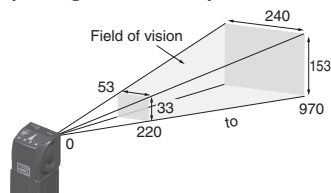

### • Wide View (Short-distance) FZ-SQ100N

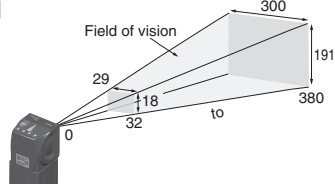

# FZ5-Series

## Ratings and Specifications (Cable, LCD Monitor)

### Camera Cables

Model	FZ-VS3 (2 m)	FZ-VSB3 (2 m)	FZ-VSL3 (2 m)	FZ-VSLB3 (2 m)
Type	Standard	Bend resistant	Right-angle	Bend resistant Right-angle
Shock resistiveness (durability)	10 to 150 Hz single amplitude 0.15 mm 3 directions, 8 strokes, 4 times			
Ambient temperature range	Operation and storage: 0 to 65 °C (with no icing or condensation)			
Ambient humidity range	Operation and storage: 40 to 70%RH (with no condensation)			
Ambient atmosphere	No corrosive gases			
Material	Cable sheath, connector: PVC			
Minimum bending radius	69mm	69mm	69mm	69mm
Weight	Approx. 170 g	Approx. 180 g	Approx. 170 g	Approx. 180 g

### Cable Extension Unit

Model	FZ-VS-J
Power supply voltage *1	11.5 to 13.5 VDC
Current consumption *2	1.5 A max.
Ambient temperature range	Operating: 0 to 50 °C; Storage: -25 to 65 °C (with no icing or condensation)
Ambient humidity range	Operating and storage: 35 to 85% (with no condensation)
Weight	Approx. 240 g
Accessories	Instruction Sheet and 4 mounting screws

\*1 A 12-VDC power supply must be provided to the Cable Extension Unit when connecting the Intelligent Compact Camera, or the Lighting Controller.

\*2 The current consumption shows when connecting the Cable Extension Unit to an external power supply.

### LCD Monitor

Model	FZ-M08
Size	8.4 inches
Type	Liquid crystal color TFT
Resolution	1,024 × 768 dots
Input signal	Analog RGB video input, 1 channel
Power supply voltage	21.6 to 26.4 VDC
Current consumption	Approx. 0.7 A max.
Ambient temperature range	Operating: 0 to 50 °C; Storage: -25 to 65 °C (with no icing or condensation)
Ambient humidity range	Operating and storage: 35 to 85% (with no condensation)
Weight	Approx. 1.2 kg
Accessories	Instruction Sheet and 4 mounting brackets

## Components and Functions

### Example of the FZ5 Sensor Controllers LCD-integrated type (4-camera type)

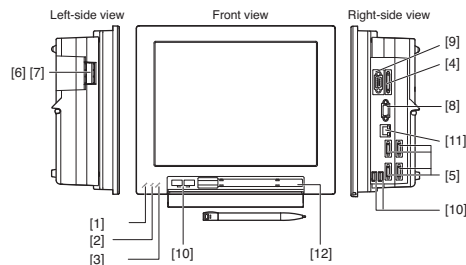

### Example of the FZ5-Lite Sensor Controllers LCD-integrated type (4-camera type)

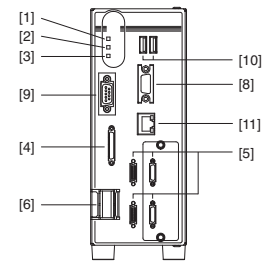

	Name	Description
[1]	POWER LED	Lit while power is ON.
[2]	RUN LED	Lit while the controller is in Run Mode.
[3]	ERROR LED	Lit when an error has occurred.
[4]	I/O connector (control lines, data lines)	Connect the controller to external devices such as a sync sensor and PLC.
[5]	Camera connector	Connect cameras.
[6]	Power	Connect a DC power supply. Wire the power supply unit independently of other devices. After wiring, replace the terminal cover.
[7]	Ground terminal	Connect the ground wire. Make sure that the controller is grounded with a separate ground wire.
[8]	Monitor connector (analog RGB)	FZ5-1100 Series/FZ5-600 Series: Cannot connect the monitor. For use this connector, contact OMRON representative. FZ5-1200 Series/FZ5-800 Series/FZ5-L350 Series: Connect monitor.
[9]	RS-232C/RS-422 connector	Connect an external device such as a personal computer or PLC.
[10]	USB connector	Connect a track ball, mouse and USB memory. A total of four USB ports are provided and any of them can be used. However, when connecting two or more USB memories, do not connect them to adjacent ports. Doing so may cause the USB memories to come into contact, resulting in malfunction or damage.
[11]	EtherNet connector	Connect the controller to a personal computer.
[12]	Touch pen (holder)	A touch pen is stored. (Provided with the LCD integrated type only)

### Long-distance Camera Cables

Model	FZ-VS4 (15 m)	FZ-VSL4 (15 m)
Type	Standard	Right-angle
Shock resistiveness (durability)	10 to 150 Hz single amplitude 0.15 mm 3 directions, 8 strokes, 4 times	
Ambient temperature range	Operation and storage: 0 to 65 °C (with no icing or condensation)	
Ambient humidity range	Operation and storage: 40 to 70%RH (with no condensation)	
Ambient atmosphere	No corrosive gases	
Material	Cable sheath, connector: PVC	
Minimum bending radius	78 mm	
Weight	Approx. 1400 g	

### Parallel Cable

Model	FZ-VP	FZ-VPX
Vibration resistiveness	10 to 150 Hz single amplitude 0.15 mm 3 directions, 8 strokes, 4 times	
Ambient temperature range	Operation: 0 to 50 °C; Storage: -20 to 65 °C (with no icing or condensation)	
Ambient humidity range	Operation and storage: 35 to 85%RH (with no condensation)	
Ambient atmosphere	No corrosive gases	
Material	Cable sheath: heat-resistant PVC Connector: resin	
Minimum bending radius	75 mm	
Weight	Approx. 160 g	Approx. 180 g

### LED Monitor Cable

Model	FZ-VM
Vibration resistiveness	10 to 150 Hz single amplitude 0.15 mm 3 directions, 8 strokes, 4 times
Ambient temperature range	Operation: 0 to 50 °C; Storage: -20 to 65 °C (with no icing or condensation)
Ambient humidity range	Operation and storage: 35 to 85%RH (with no condensation)
Ambient atmosphere	No corrosive gases
Material	Cable sheath: heat-resistant PVC Connector: PVC
Minimum bending radius	75 mm
Weight	Approx. 170 g



# Processing Items

Group	Icon	Processing Item	
Measurement		Search	Used to identify the shapes and calculate the position of measurement objects.
		Flexible Search	Recognizing the shapes of workpieces with variation and detecting their positions.
		Sensitive Search	Search a small difference by dividing the search model in detail, and calculating the correlation.
		ECM Search	Used to search the similar part of model form input image. Detect the evaluation value and position.
		EC Circle Search	Extract circles using "round " shape information and get position, radius and quantity in high preciseness.
		Shape Search II	Used to search the similar part of model from input image regardless of environmental changes. Detect the evaluation value and position.
		Shape Search III	Robust detection of positions is possible at high-speed and with high precision incorporating environmental fluctuations, such as differences in individual shapes of the workpieces, pose fluctuations, noise superimposition and shielding.
		EC Corner	This processing item measures a corner position (corner) of a workpiece.
		Ec Cross	The center position of a crosshair shape is measured using the lines created by the edge information on each side of the crosshair.
		Classification	Used when various kinds of products on the assembly line need to be sorted and identified.
		Edge Position	Measure position of measurement objects according to the color change in measurement area.
		Edge Pitch	Detect edges by color change in measurement area. Used for calculating number of pins of IC and connectors.
		Scan Edge Position	Measure peak/bottom edge position of workpieces according to the color change in separated measurement area.
		Scan Edge Width	Measure max/min/average width of workpieces according to the color change in separated measurement area.
		Circular Scan Edge Position	Measure center axis, diameter and radius of circular workpieces.
		Circular Scan Edge Width	Measure center axis, width and thickness of ring workpieces.
		Intersection	Calculate approximate lines from the edge information on two sides of a square workpiece to measure the angle formed at the intersection of the two lines.
		Color Data	Used for detecting presence and mixed varieties of products by using color average and deviation.
		Gravity and Area	Used to measure area, center of gravity of workpieces by extracting the color to be measured.
		Labeling	Used to measure number, area and gravity of workpieces by extracting registered color.
		Label Data	Selecting one region of extracted Labeling, and get that measurement. Area and Gravity position can be got and judged.
		Defect	Used for appearance measurement of plain-color measurement objects such as defects, stains and burrs.
		Precise Defect	Check the defect on the object. Parameters for extraction defect can be set precisely.
		Fine Matching	Difference can be detected by overlapping and comparing (matching) registered fine images with input images.
		Character Inspect	Recognize character according correlation search with model image registered in [Model Dictionary].
		Date Verification	Reading character string is verified with internal date.
		Model Dictionary	Register character pattern as dictionary. The pattern is used in [Character Inspection].
		2DCode *2	Recognize 2D code and display where the code quality is poor.
		Barcode *1	Recognize barcode, verify and output decoded characters.
		OCR	Recognize and read characters in images as character information.
		OCR User Dictionary	Register dictionary data to use for OCR.
		Circle Angle	Used for calculating angle of inclination of circular measurement objects.
	Glue Bead Inspection	You can inspect coating of a specified color for gaps or runoffs along the coating path.	
Input Image		Camera Image Input	To input images from cameras. And set up the conditions to input images from cameras. (To FZ5 Sensor Controllers only)
		Camera Image Input FH	To input images from cameras. And set up the conditions to input images from cameras. (For FH Sensor Controllers only)

Group	Icon	Processing Item		
Input Image		Camera Image Input HDR	Create high-dynamic range images by acquiring several images with different conditions.	
		Camera Image Input HDRLite	HDR function for FZ5-□□ Intelligent Compact Cameras.	
		Camera Switch	To switch the cameras used for measurement. Not input images from cameras again.	
		Measurement Image Switching	To switch the images used for measurement. Not input images from camera again.	
		Multi-trigger Imaging	The Multi-trigger Imaging processing item captures multiple images at user-defined timings and executes parallel measurement for each image. Insert the Multi-trigger Imaging to the top of the flow.	
		Multi-trigger Imaging Task	The Multi-trigger Imaging processing item captures multiple images at user-defined timings and executes parallel measurement for each image. Insert this processing item to the top of the processing which requires imaging for multiple times.	
	Compensate image		Position Compensation	Used when positions are differed. Correct measurement is performed by correcting position of input images.
			Filtering	Used for processing images input from cameras in order to make them easier to be measured.
			Background Suppression	To enhance contrast of images by extracting color in specified brightness.
			Brightness Correct Filter	Track brightness change of entire screen and remove gradual brightness change such as uneven brightness.
		Color Gray Filter	Color image is converted into monochrome images to emphasize specific color.	
		Extract Color Filter	Convert color image to color extracted image or binary image.	
		Anti Color Shading	To remove the irregular color/pattern by uniformizing max.2 specified colors.	
		Stripes Removal Filter II	Remove the background pattern of vertical, horizontal and diagonal stripes.	
		Polar Transformation	Rectify the image by polar transformation. Useful for OCR or pattern inspection printed on circle.	
		Trapezoidal Correction	Rectify the trapezoidal deformed image.	
		Machine Simulator	How the alignment marks would move on the image when each stage or robot axis is controlled can be checked.	
		Image Subtraction	The registered model image and measurement image are compared and only the different pixels are extracted and converted to an image.	
		Advanced filter	Process the images acquired from cameras in order to make them easier to measure. This processing item consolidates existing image conversion filtering into one processing item and adds extra functions.	
		Panorama	Combine multiple image to create one big image.	
Support measurement			Unit Macro	Advanced arithmetic processing can be easily incorporated into workflow as Unit Macro processing items.
			Unit Calculation Macro	This function is convenient when the user wants to calculate a value using an original calculation formula or change the set value or system data of a processing item.
			Calculation	Used when using the judge results and measured values of Procltem which are registered in processing units.
			Line Regression	Used for calculating regression line from plural measurement coordinate.
		Circle Regression	Used for calculating regression circle from plural measurement coordinate.	
		Precise Calibration	Used for calibration corresponding to trapezoidal distortion and lens distortion.	
		User Data	Used for setting of the data that can be used as common constants and variables in scene group data.	
		Set Unit Data	Used to change the Procltem data (setting parameters, etc.) that has been set up in a scene.	
		Get Unit Data	Used to get one data (measured results, setting parameters, etc.) of Procltem that has been set up in a scene.	
		Set Unit Figure	Used for re-setting the figure data (model, measurement area ) registered in an unit.	
		Get Unit Figure	Used for get the figure data (model, measurement area ) registered in an unit.	
		Trend Monitor	Used for displaying the information about results on the monitor, facilitating to avoid NG and analyze causes.	
		Image Logging	Used for saving the measurement images to the memory and USB memory.	
		Image Conversion Logging	Used for saving the measurement images in JPEG and BMP format.	
	Data Logging	Used for saving the measurement data to the memory and USB memory.		
	Elapsed Time	Used for calculating the elapsed time since the measurement trigger input.		
	Wait	Processing is stopped only at the set time. The standby time is set by the unit of [ms].		

# FZ5-Series

Group	Icon	Processing Item	
Support measurement		Focus	Focus setting is supported.
		Iris	Focus and aperture setting is supported.
		Parallelize*3	A part of the measurement flow is divided into two or more tasks and processed in parallel to shorten the measurement time. This processing item is placed at the top of processing to be performed in parallel.
		Parallelize Task*3	A part of the measurement flow is divided into two or more tasks and processed in parallel to shorten the measurement time. This processing item is placed immediately before processing to be performed in parallel between Parallelize and Parallelize End.
		Statistics	Used when you need to calculate an average of multiple measurement results.
		Reference Calib Data	Calibration data and distortion compensation data held under other processing items can be referenced.
		Position Data Calculation	The specified position angle is calculated from the measured positions.
		Stage Data	Sets and stores data related to stages.
		Robot Data	Sets and stores data related to robots.
		Vision Master Calibration	This processing item automatically calculates the entire axis movement amount of the control equipment necessary for calibration.
		PLC Mastro Calibration	Calibration data is created using a communication command from PLC.
		Convert Position Data	The position angle after the specified axis movement is calculated.
		Movement Single Position	The axis movement that is required to match the measured position angle to the reference position angle is calculated.
		Movement Multi Points	The axis movements that are required to match the measured position angles to the corresponding reference position angles are calculated.
		Detection Point	Obtains position/angle information by referring to the coordinate values measured with the Measurement Processing Unit.
		Camera Calibration	By setting the camera calibration, the measurement result can be converted and output as actual dimensions.
		Data Save	The set data can be saved in the controller main unit or as scene data. The data is held even after the FH/FZ power is turned off.

Group	Icon	Processing Item	
Branch		Conditional Branch	Used where more than two kinds of products on the production line need to be detected separately.
		End	This Procltem must be set up as the last processing unit of a branch.
		DI Branch	Same as Procltem "Branch". But you can change the targets of conditional branching via external inputs.
		Control Flow Normal	Set the measurement flow processing into the wait state in which the specific no-protocol command can be executed.
		Control Flow PLC Link	Set the measurement flow processing into the wait state in which the specific PLC Link command can be executed.
		Control Flow Parallel	Set the measurement flow processing into the wait state in which the specific parallel command can be executed.
		Control Flow Fieldbus	Set the measurement flow processing into the wait state in which the specific Fieldbus command can be executed.
		Selective Branch	Easily branch to multiple destinations.
	Output result		Data Output
		Parallel Data Output	Used when you need to output data to the external devices such as PLC or PC via parallel ports.
		Parallel Judgement Output	Used when you need to output judgement results to the external devices such as PLC or PC via parallel ports.
		Fieldbus Data Output	Outputs data to an external device, such as a Programmable Controller, through a fieldbus interface.
Display result		Result Display	Used for displaying the texts or the figures in the camera image.
		Display Image File	Display selected image file.
		Display Last NG Image	Display the last NG images.

- \*1 Bar Codes that can be read : JAN/EAN/UPC (including add-on codes), Code 39, Codabar (NW-7), ITF (Interleaved 2 of 5), Code 93, Code 128, GS1-128, GS1 DataBar (RSS-14 / RSS Limited / RSS Expanded), Pharmacode
- \*2 2D Codes that can be read : Data Matrix (ECC200), QR Code
- \*3 FZ5-L3□□/6□□ controllers do not support.

## Dimensions

(Unit: mm)

### Sensor Controllers

- FZ5-series LCD-integrated type
- FZ5-1200/-1205/-1200-10/-1205-10
- FZ5-1100/-1105/-1100-10/-1105-10
- FZ5-800/-805/-800-10/-805-10
- FZ5-600/-605/-600-10/-605-10

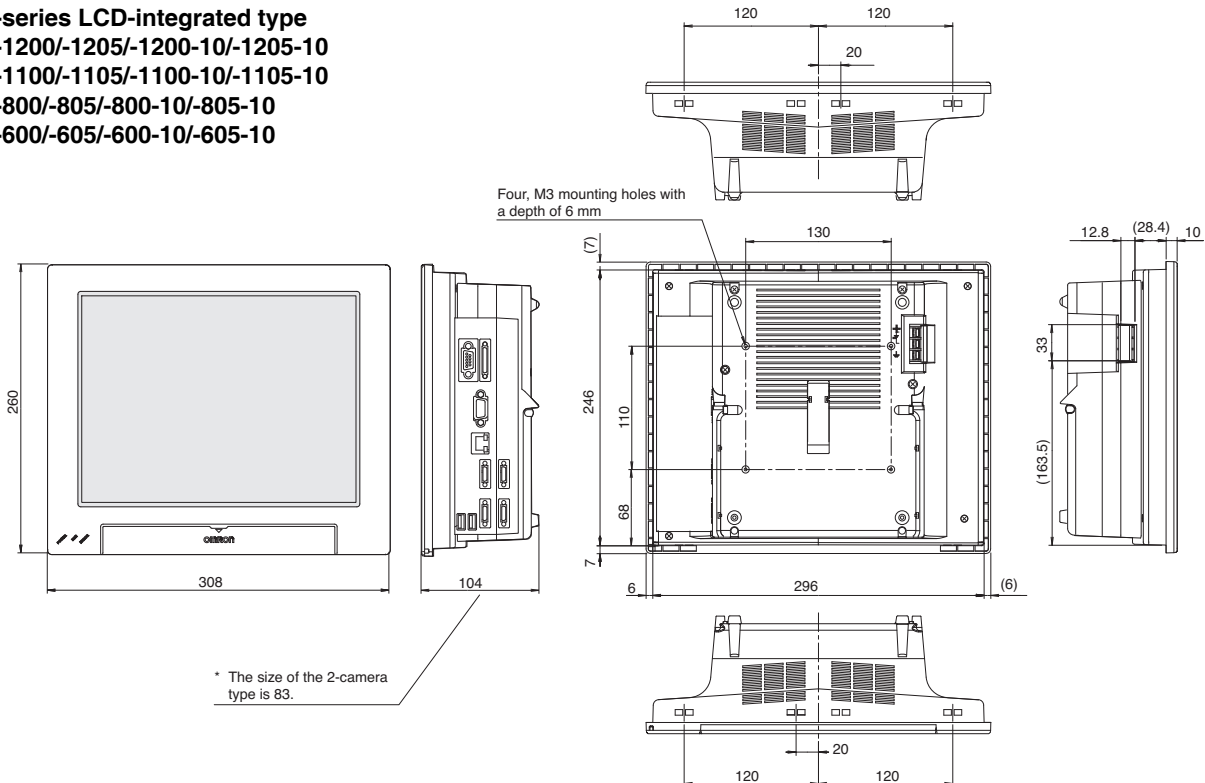

**FZ5-series Lite Box-type**  
**FZ5-L350/-L355/-L350-10/-L355-10**

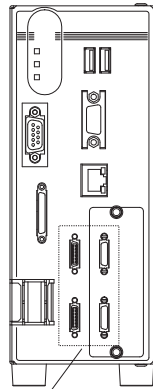

\* The 2-camera type has only two camera connectors on its right side.

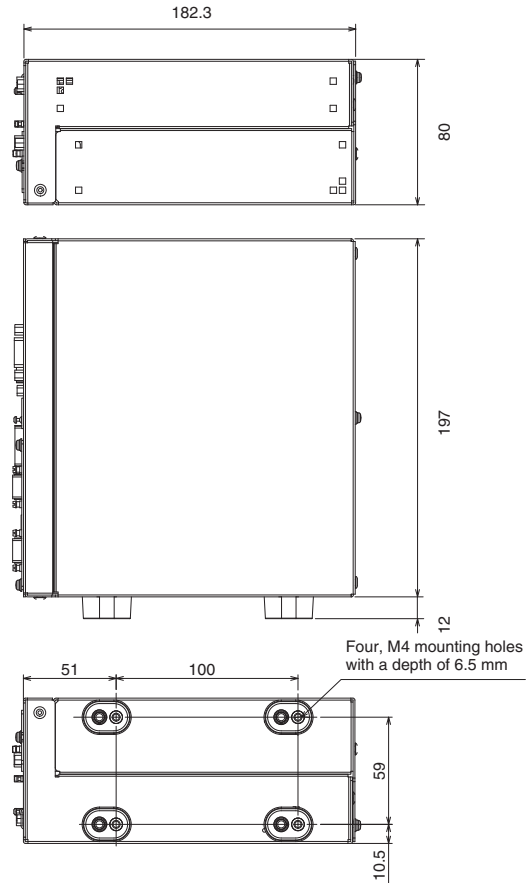

**Cameras**

**Digital CCD/CMOS Cameras**

**300,000-pixel camera**

FZ-S  
 FZ-SC

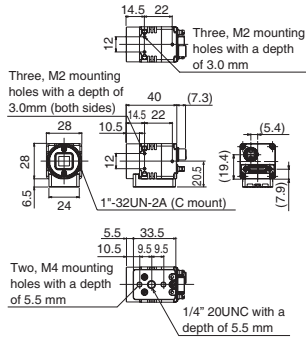

**2 million-pixel camera**

FZ-S2M  
 FZ-SC2M

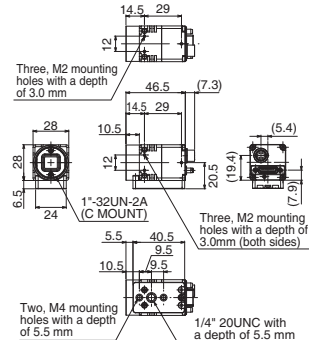

**5 million-pixel camera**

FZ-S5M3  
 FZ-SC5M3

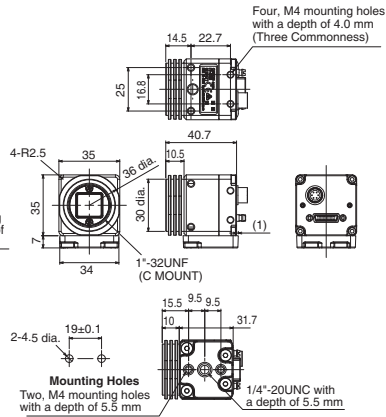



**Parallel Cable**

FZ-VP

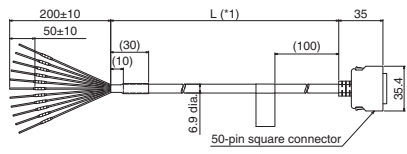

\*1. cable is available in 2m/5m.

FZ-VPX

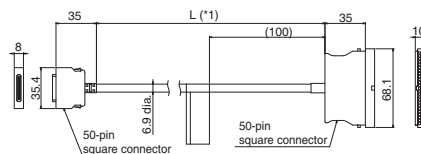

\*1. cable is available in 2m/5m.

**LED Monitor Cable**

FZ-VM

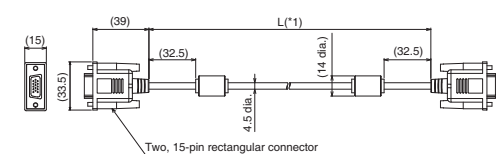

\*1. cable is available in 2m/5m.

**LCD Monitor**

FZ-M08

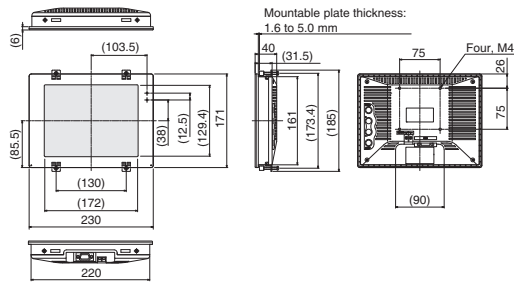

**Camera Cable Extension Unit**

FZ-VSJ

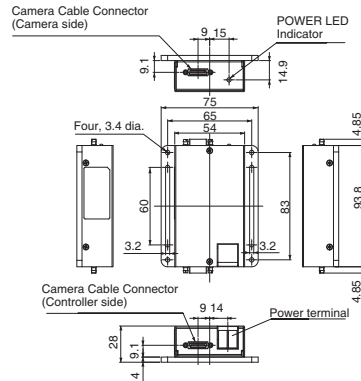

**Optical Chart**

**Meaning of Optical Chart**

The X axis of the optical chart shows the field of vision (mm) (\*1), and the Y axis of the optical chart shows the camera installation distance (mm) (\*2).

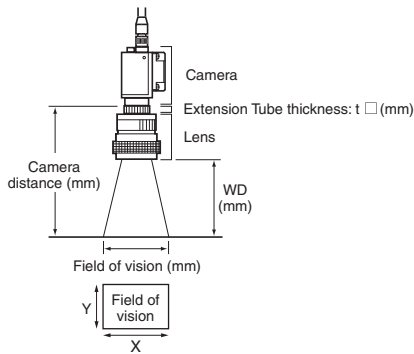

- \*1. The lengths of the fields of vision given in the optical charts are the lengths of the Y axis.
- \*2. The vertical axis represents WD for small cameras.

**Digital CCD/CMOS Camera**  
**FZ-S□5M□,**  
**5 million-pixel**

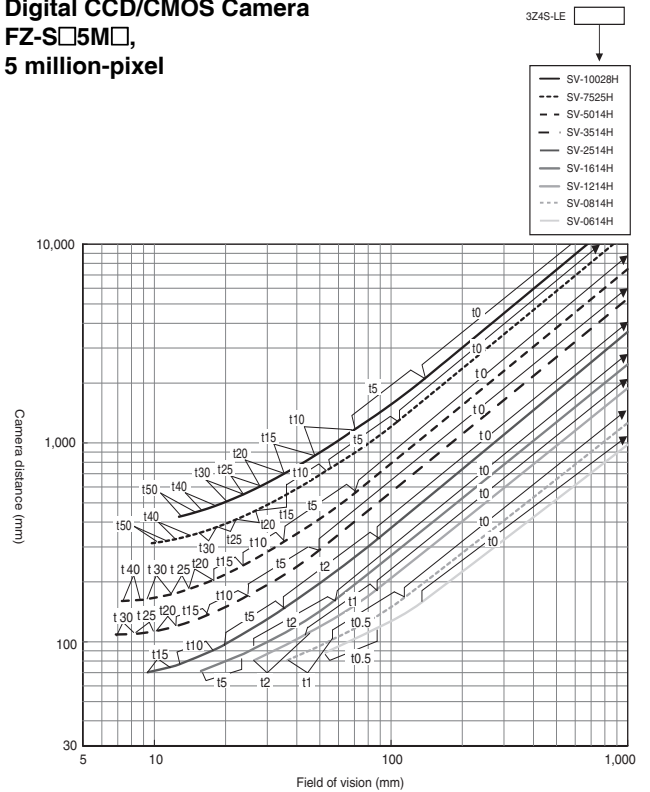

## Digital CCD Camera FZ-S□2M, 2 million-pixel

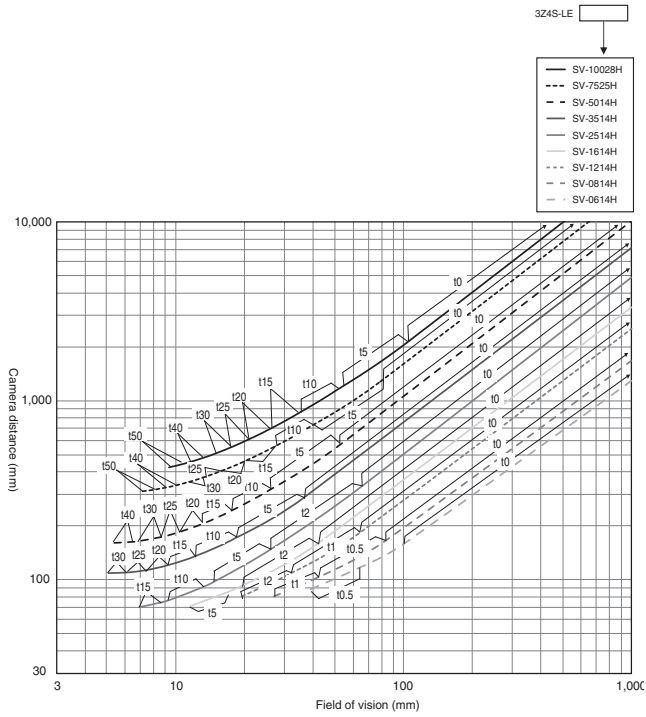

## Digital CCD Camera FZ-S□, 300,000-pixel

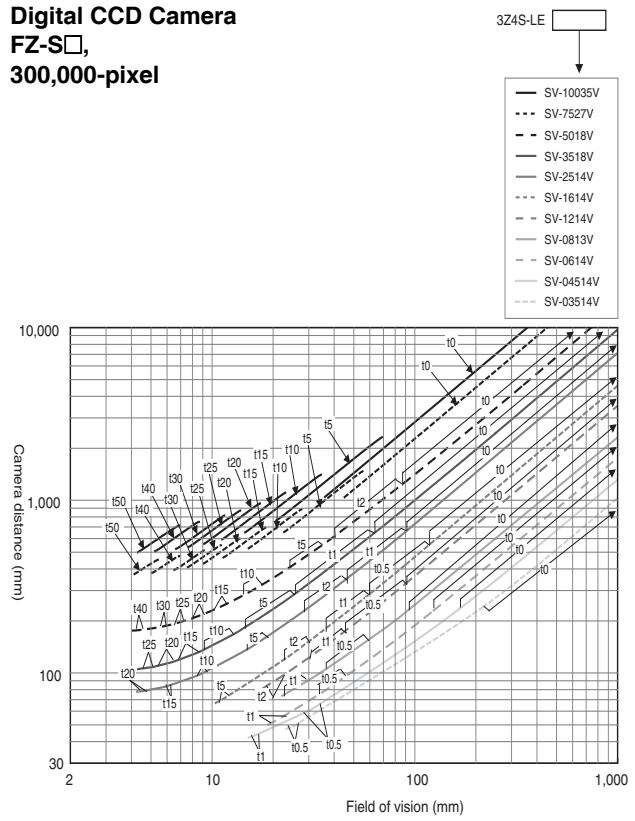

## Small Digital CCD Cameras FZ-SF□, FZ-SP□, 300,000-pixel

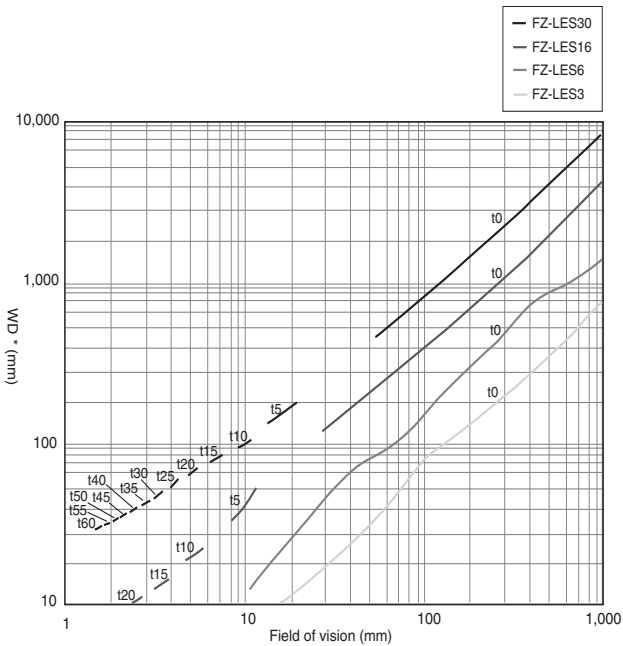

\* The vertical axis represents WD, not installation distance.

## Digital CCD/CMOS Camera FZ-S□5M□, 5 million-pixel (Vibrations and shocks resistant)

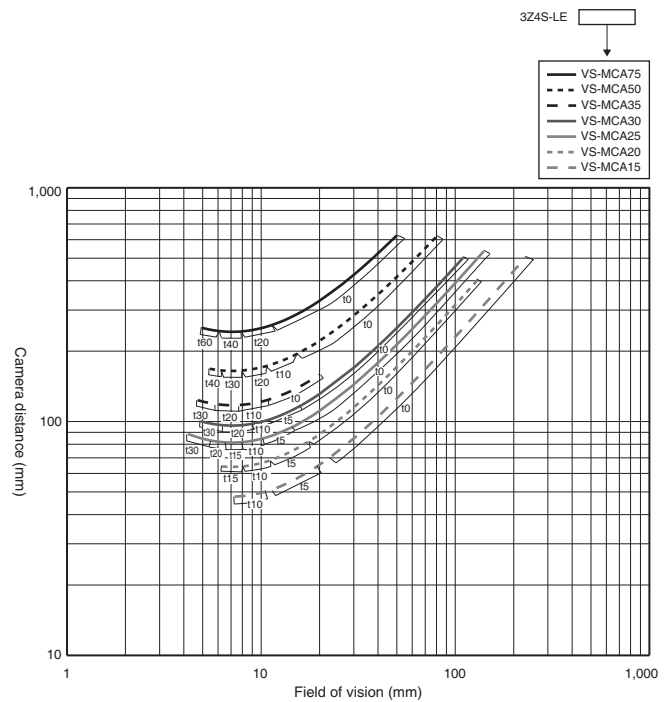

**Digital CCD Camera**  
**FZ-S□2M,**  
**2 million-pixel**  
**(Vibrations and shocks resistant)**

3Z4S-LE

- VS-MCA75
- - VS-MCA50
- · VS-MCA35
- VS-MCA30
- VS-MCA25
- - VS-MCA20
- · VS-MCA15

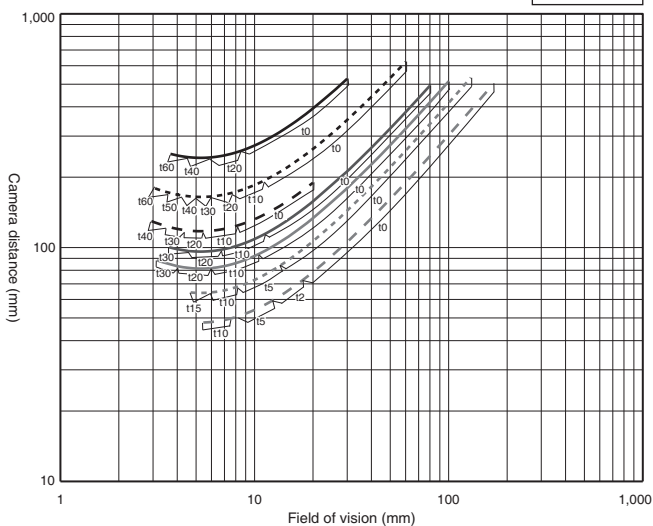

**Digital CCD Camera**  
**FZ-S□,**  
**300,000-pixel**  
**(Vibrations and shocks resistant)**

3Z4S-LE

- VS-MCA75
- - VS-MCA50
- · VS-MCA35
- VS-MCA30
- VS-MCA25
- - VS-MCA20
- · VS-MCA15

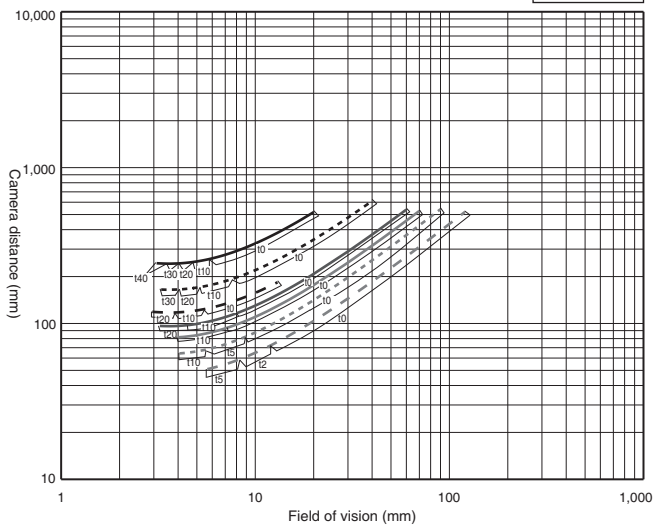

**Related Manuals**

Man.No.	Model number	Manual
Z421	FZ5	Vision System FZ5 Series User's Manual
Z424	FZ5	Vision System FZ5 Series Processing Item Function Reference Manual
Z422	FZ5	Vision System FZ5 Series User's Manual for Communications Settings
Z423	FZ5	Vision System FZ5 series Hardware Setup Manual
Z425	FZ5	Vision System FZ5 series Macro Customize Functions Programming Manual





# Terms and Conditions Agreement

## **Read and understand this catalog.**

Please read and understand this catalog before purchasing the products. Please consult your OMRON representative if you have any questions or comments.

## **Warranties.**

- (a) Exclusive Warranty. Omron's exclusive warranty is that the Products will be free from defects in materials and workmanship for a period of twelve months from the date of sale by Omron (or such other period expressed in writing by Omron). Omron disclaims all other warranties, express or implied.
- (b) Limitations. OMRON MAKES NO WARRANTY OR REPRESENTATION, EXPRESS OR IMPLIED, ABOUT NON-INFRINGEMENT, MERCHANTABILITY OR FITNESS FOR A PARTICULAR PURPOSE OF THE PRODUCTS. BUYER ACKNOWLEDGES THAT IT ALONE HAS DETERMINED THAT THE PRODUCTS WILL SUITABLY MEET THE REQUIREMENTS OF THEIR INTENDED USE.

Omron further disclaims all warranties and responsibility of any type for claims or expenses based on infringement by the Products or otherwise of any intellectual property right. (c) Buyer Remedy. Omron's sole obligation hereunder shall be, at Omron's election, to (i) replace (in the form originally shipped with Buyer responsible for labor charges for removal or replacement thereof) the non-complying Product, (ii) repair the non-complying Product, or (iii) repay or credit Buyer an amount equal to the purchase price of the non-complying Product; provided that in no event shall Omron be responsible for warranty, repair, indemnity or any other claims or expenses regarding the Products unless Omron's analysis confirms that the Products were properly handled, stored, installed and maintained and not subject to contamination, abuse, misuse or inappropriate modification. Return of any Products by Buyer must be approved in writing by Omron before shipment. Omron Companies shall not be liable for the suitability or unsuitability or the results from the use of Products in combination with any electrical or electronic components, circuits, system assemblies or any other materials or substances or environments. Any advice, recommendations or information given orally or in writing, are not to be construed as an amendment or addition to the above warranty.

See <http://www.omron.com/global/> or contact your Omron representative for published information.

## **Limitation on Liability; Etc.**

OMRON COMPANIES SHALL NOT BE LIABLE FOR SPECIAL, INDIRECT, INCIDENTAL, OR CONSEQUENTIAL DAMAGES, LOSS OF PROFITS OR PRODUCTION OR COMMERCIAL LOSS IN ANY WAY CONNECTED WITH THE PRODUCTS, WHETHER SUCH CLAIM IS BASED IN CONTRACT, WARRANTY, NEGLIGENCE OR STRICT LIABILITY.

Further, in no event shall liability of Omron Companies exceed the individual price of the Product on which liability is asserted.

## **Suitability of Use.**

Omron Companies shall not be responsible for conformity with any standards, codes or regulations which apply to the combination of the Product in the Buyer's application or use of the Product. At Buyer's request, Omron will provide applicable third party certification documents identifying ratings and limitations of use which apply to the Product. This information by itself is not sufficient for a complete determination of the suitability of the Product in combination with the end product, machine, system, or other application or use. Buyer shall be solely responsible for determining appropriateness of the particular Product with respect to Buyer's application, product or system. Buyer shall take application responsibility in all cases.

NEVER USE THE PRODUCT FOR AN APPLICATION INVOLVING SERIOUS RISK TO LIFE OR PROPERTY OR IN LARGE QUANTITIES WITHOUT ENSURING THAT THE SYSTEM AS A WHOLE HAS BEEN DESIGNED TO ADDRESS THE RISKS, AND THAT THE OMRON PRODUCT(S) IS PROPERLY RATED AND INSTALLED FOR THE INTENDED USE WITHIN THE OVERALL EQUIPMENT OR SYSTEM.

## **Programmable Products.**

Omron Companies shall not be responsible for the user's programming of a programmable Product, or any consequence thereof.

## **Performance Data.**

Data presented in Omron Company websites, catalogs and other materials is provided as a guide for the user in determining suitability and does not constitute a warranty. It may represent the result of Omron's test conditions, and the user must correlate it to actual application requirements. Actual performance is subject to the Omron's Warranty and Limitations of Liability.

## **Change in Specifications.**

Product specifications and accessories may be changed at any time based on improvements and other reasons. It is our practice to change part numbers when published ratings or features are changed, or when significant construction changes are made. However, some specifications of the Product may be changed without any notice. When in doubt, special part numbers may be assigned to fix or establish key specifications for your application. Please consult with your Omron's representative at any time to confirm actual specifications of purchased Product.

## **Errors and Omissions.**

Information presented by Omron Companies has been checked and is believed to be accurate; however, no responsibility is assumed for clerical, typographical or proofreading errors or omissions.

**Note:** Do not use this document to operate the Unit.

**OMRON Corporation Industrial Automation Company**  
Tokyo, JAPAN

**Contact: [www.ia.omron.com](http://www.ia.omron.com)**

**Regional Headquarters**

**OMRON EUROPE B.V.**  
**Sensor Business Unit**

Carl-Benz-Str. 4, D-71154 Nufringen, Germany  
Tel: (49) 7032-8111-0/Fax: (49) 7032-8111-199

**OMRON ELECTRONICS LLC**

2895 Greenspoint Parkway, Suite 200  
Hoffman Estates, IL 60169 U.S.A  
Tel: (1) 847-843-7900/Fax: (1) 847-843-7787

**OMRON ASIA PACIFIC PTE. LTD.**

No. 438A Alexandra Road # 05-05/08 (Lobby 2),  
Alexandra Technopark,  
Singapore 119967  
Tel: (65) 6835-3011/Fax: (65) 6835-2711

**OMRON (CHINA) CO., LTD.**

Room 2211, Bank of China Tower,  
200 Yin Cheng Zhong Road,  
PuDong New Area, Shanghai, 200120, China  
Tel: (86) 21-5037-2222/Fax: (86) 21-5037-2200

**Authorized Distributor:**

© OMRON Corporation 2015-2017 All Rights Reserved.  
In the interest of product improvement,  
specifications are subject to change without notice.

**CSM\_10\_3\_0919**  
**Cat. No. Q203-E1-03**

1017(0115)