

Robert Bosch Power Tools GmbH
70538 Stuttgart
GERMANY

www.bosch-pt.com

1 609 92A 1UV (2014.09) AS / 76 **EURO**



1 609 92A 1UV

GWS Professional

9-115 | 9-125 | 11-125 | 12-125 CI | 13-125 CI | 13-125 CIE |
15-125 CIE | 15-125 Inox | 17-125 CI | 17-125 CIE | 17-125 CIT | 17-150 CI |
17-125 Inox



- en** Original instructions
- cn** 正本使用说明书
- tw** 原始使用說明書
- ko** 사용 설명서 원본
- th** หนังสือคู่มือการใช้งานฉบับต้นแบบ
- id** Petunjuk-Petunjuk untuk Penggunaan Orisinal
- vi** Bản gốc hướng dẫn sử dụng





English	Page	3
中文	页	10
中文	頁	17
한국어	페이지	23
ภาษาไทย	หน้า	30
Bahasa Indonesia	Halaman	38
Tiếng Việt	Trang	46

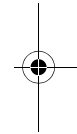

English

General Power Tool Safety Warnings

⚠ WARNING Read all safety warnings and all instructions. Failure to follow the warnings and instructions may result in electric shock, fire and/or serious injury.

Save all warnings and instructions for future reference.

The term "power tool" in the warnings refers to your mains-operated (corded) power tool or battery-operated (cordless) power tool.

Work area safety

- ▶ **Keep work area clean and well lit.** Cluttered or dark areas invite accidents.
- ▶ **Do not operate power tools in explosive atmospheres, such as in the presence of flammable liquids, gases or dust.** Power tools create sparks which may ignite the dust or fumes.
- ▶ **Keep children and bystanders away while operating a power tool.** Distractions can cause you to lose control.

Electrical safety

- ▶ **Power tool plugs must match the outlet. Never modify the plug in any way. Do not use any adapter plugs with earthed (grounded) power tools.** Unmodified plugs and matching outlets will reduce risk of electric shock.
- ▶ **Avoid body contact with earthed or grounded surfaces, such as pipes, radiators, ranges and refrigerators.** There is an increased risk of electric shock if your body is earthed or grounded.
- ▶ **Do not expose power tools to rain or wet conditions.** Water entering a power tool will increase the risk of electric shock.
- ▶ **Do not abuse the cord. Never use the cord for carrying, pulling or unplugging the power tool. Keep cord away from heat, oil, sharp edges and moving parts.** Damaged or entangled cords increase the risk of electric shock.
- ▶ **When operating a power tool outdoors, use an extension cord suitable for outdoor use.** Use of a cord suitable for outdoor use reduces the risk of electric shock.
- ▶ **If operating a power tool in a damp location is unavoidable, use a residual current device (RCD) protected supply.** Use of an RCD reduces the risk of electric shock.

Personal safety

- ▶ **Stay alert, watch what you are doing and use common sense when operating a power tool. Do not use a power tool while you are tired or under the influence of drugs, alcohol or medication.** A moment of inattention while operating power tools may result in serious personal injury.
- ▶ **Use personal protective equipment. Always wear eye protection.** Protective equipment such as dust mask, non-skid safety shoes, hard hat, or hearing protection

used for appropriate conditions will reduce personal injuries.

- ▶ **Prevent unintentional starting. Ensure the switch is in the off-position before connecting to power source and/or battery pack, picking up or carrying the tool.** Carrying power tools with your finger on the switch or engaging power tools that have the switch on invites accidents.
- ▶ **Remove any adjusting key or wrench before turning the power tool on.** A wrench or a key left attached to a rotating part of the power tool may result in personal injury.
- ▶ **Do not overreach. Keep proper footing and balance at all times.** This enables better control of the power tool in unexpected situations.
- ▶ **Dress properly. Do not wear loose clothing or jewelry. Keep your hair, clothing and gloves away from moving parts.** Loose clothes, jewellery or long hair can be caught in moving parts.
- ▶ **If devices are provided for the connection of dust extraction and collection facilities, ensure these are connected and properly used.** Use of dust collection can reduce dust-related hazards.

Power tool use and care

- ▶ **Do not force the power tool. Use the correct power tool for your application.** The correct power tool will do the job better and safer at the rate for which it was designed.
- ▶ **Do not use the power tool if the switch does not turn it on and off.** Any power tool that cannot be controlled with the switch is dangerous and must be repaired.
- ▶ **Disconnect the plug from the power source and/or the battery pack from the power tool before making any adjustments, changing accessories, or storing power tools.** Such preventive safety measures reduce the risk of starting the power tool accidentally.
- ▶ **Store idle power tools out of the reach of children and do not allow persons unfamiliar with the power tool or these instructions to operate the power tool.** Power tools are dangerous in the hands of untrained users.
- ▶ **Maintain power tools. Check for misalignment or binding of moving parts, breakage of parts and any other condition that may affect the power tool's operation. If damaged, have the power tool repaired before use.** Many accidents are caused by poorly maintained power tools.
- ▶ **Keep cutting tools sharp and clean.** Properly maintained cutting tools with sharp cutting edges are less likely to bind and are easier to control.
- ▶ **Use the power tool, accessories and tool bits etc. in accordance with these instructions, taking into account the working conditions and the work to be performed.** Use of the power tool for operations different from those intended could result in a hazardous situation.

4 | English

Service

- ▶ **Have your power tool serviced by a qualified repair person using only identical replacement parts.** This will ensure that the safety of the power tool is maintained.

Safety Warnings for Angle Grinder**Safety Warnings common for Grinding, Sanding, Wire Brushing or Abrasive Cutting Off Operations**

- ▶ **This power tool is intended to function as a grinder, sander, wire brush or cut-off tool. Read all safety warnings, instructions, illustrations and specifications provided with this power tool.** Failure to follow all instructions listed below may result in electric shock, fire and/or serious injury.
- ▶ **Operations such as polishing are not recommended to be performed with this power tool.** Operations for which the power tool was not designed may create a hazard and cause personal injury.
- ▶ **Do not use accessories which are not specifically designed and recommended by the tool manufacturer.** Just because the accessory can be attached to your power tool, it does not assure safe operation.
- ▶ **The rated speed of the accessory must be at least equal to the maximum speed marked on the power tool.** Accessories running faster than their rated speed can break and fly apart.
- ▶ **The outside diameter and the thickness of your accessory must be within the capacity rating of your power tool.** Incorrectly sized accessories cannot be adequately guarded or controlled.
- ▶ **Threaded mounting of accessories must match the grinder spindle thread. For accessories mounted by flanges, the arbour hole of the accessory must fit the locating diameter of the flange.** Accessories that do not match the mounting hardware of the power tool will run out of balance, vibrate excessively and may cause loss of control.
- ▶ **Do not use a damaged accessory. Before each use inspect the accessory such as abrasive wheels for chips and cracks, backing pad for cracks, tear or excess wear, wire brush for loose or cracked wires. If power tool or accessory is dropped, inspect for damage or install an undamaged accessory. After inspecting and installing an accessory, position yourself and bystanders away from the plane of the rotating accessory and run the power tool at maximum no-load speed for one minute.** Damaged accessories will normally break apart during this test time.
- ▶ **Wear personal protective equipment. Depending on application, use face shield, safety goggles or safety glasses. As appropriate, wear dust mask, hearing protectors, gloves and shop apron capable of stopping small abrasive or workpiece fragments.** The eye protection must be capable of stopping flying debris generated by various operations. The dust mask or respirator must be capable of filtering particles generated by your operation.

Prolonged exposure to high intensity noise may cause hearing loss.

- ▶ **Keep bystanders a safe distance away from work area. Anyone entering the work area must wear personal protective equipment.** Fragments of workpiece or of a broken accessory may fly away and cause injury beyond immediate area of operation.
- ▶ **Hold the power tool by insulated gripping surfaces only, when performing an operation where the cutting accessory may contact hidden wiring or its own cord.** Cutting accessory contacting a "live" wire may make exposed metal parts of the power tool "live" and could give the operator an electric shock.
- ▶ **Position the cord clear of the spinning accessory.** If you lose control, the cord may be cut or snagged and your hand or arm may be pulled into the spinning wheel.
- ▶ **Never lay the power tool down until the accessory has come to a complete stop.** The spinning wheel may grab the surface and pull the power tool out of your control.
- ▶ **Do not run the power tool while carrying it at your side.** Accidental contact with the spinning accessory could snag your clothing, pulling the accessory into your body.
- ▶ **Regularly clean the power tool's air vents.** The motor's fan will draw the dust inside the housing and excessive accumulation of powdered metal may cause electrical hazards.
- ▶ **Do not operate the power tool near flammable materials.** Sparks could ignite these materials.
- ▶ **Do not use accessories that require liquid coolants.** Using water or other liquid coolants may result in electrocution or shock.

Kickback and related warnings

- ▶ Kickback is a sudden reaction to a pinched or snagged rotating wheel, backing pad, brush or any other accessory. Pinching or snagging causes rapid stalling of the rotating accessory which in turn causes the uncontrolled power tool to be forced in the direction opposite of the accessory's rotation at the point of the binding. For example, if an abrasive wheel is snagged or pinched by the workpiece, the edge of the wheel that is entering into the pinch point can dig into the surface of the material causing the wheel to climb out or kick out. The wheel may either jump toward or away from the operator, depending on direction of the wheel's movement at the point of pinching. Abrasive wheels may also break under these conditions. Kickback is the result of power tool misuse and/or incorrect operating procedures or conditions and can be avoided by taking proper precautions as given below.
- ▶ **Maintain a firm grip on the power tool and position your body and arm to allow you to resist kickback forces. Always use auxiliary handle, if provided, for maximum control over kickback or torque reaction during start-up.** The operator can control torque reactions or kickback forces, if proper precautions are taken.

- ▶ **Never place your hand near the rotating accessory.** Accessory may kickback over your hand.
- ▶ **Do not position your body in the area where power tool will move if kickback occurs.** Kickback will propel the tool in direction opposite to the wheel's movement at the point of snagging.
- ▶ **Use special care when working corners, sharp edges, etc. Avoid bouncing and snagging the accessory.** Corners, sharp edges or bouncing have a tendency to snag the rotating accessory and cause loss of control or kickback.
- ▶ **Do not attach a saw chain woodcarving blade or toothed saw blade.** Such blades create frequent kickback and loss of control.

Safety warnings specific for Grinding and Abrasive Cutting-Off operations

- ▶ **Use only wheel types that are recommended for your power tool and the specific guard designed for the selected wheel.** Wheels for which the power tool was not designed cannot be adequately guarded and are unsafe.
- ▶ **The grinding surface of the centre depressed wheels must be mounted below the plane of the guard lip.** An improperly mounted wheel that projects through the plane of the guard lip cannot be adequately protected.
- ▶ **The guard must be securely attached to the power tool and positioned for maximum safety, so the least amount of wheel is exposed towards the operator.** The guard helps to protect operator from broken wheel fragments, accidental contact with wheel and sparks that could ignite clothing.
- ▶ **Wheels must be used only for recommended applications. For example: do not grind with the side of the cut-off wheel.** Abrasive cut-off wheels are intended for peripheral grinding; side forces applied to these wheels may cause them to shatter.
- ▶ **Always use undamaged wheel flanges that are of correct size and shape for your selected wheel.** Proper wheel flanges support the wheel thus reducing the possibility of wheel breakage. Flanges for cut-off wheels may be different from grinding wheel flanges.
- ▶ **Do not use worn down reinforced wheels from larger power tools.** Wheels intended for larger power tools are not suitable for the higher speed of a smaller tool and may burst.

Additional safety warnings specific for abrasive cutting off operations

- ▶ **Do not "jam" the cut-off wheel or apply excessive pressure. Do not attempt to make an excessive depth of cut.** Overstressing the wheel increases the loading and susceptibility to twisting or binding of the wheel in the cut and the possibility of kickback or wheel breakage.
- ▶ **Do not position your body in line with and behind the rotating wheel.** When the wheel, at the point of operation, is moving away from your body, the possible kickback may propel the spinning wheel and the power tool directly at you.

- ▶ **When wheel is binding or when interrupting a cut for any reason, switch off the power tool and hold the power tool motionless until the wheel comes to a complete stop. Never attempt to remove the cut-off wheel from the cut while the wheel is in motion otherwise kickback may occur.** Investigate and take corrective action to eliminate the cause of wheel binding.
- ▶ **Do not restart the cutting operation in the workpiece. Let the wheel reach full speed and carefully re-enter the cut.** The wheel may bind, walk up or kickback if the power tool is restarted in the workpiece.
- ▶ **Support panels or any oversized workpiece to minimize the risk of wheel pinching and kickback.** Large workpieces tend to sag under their own weight. Supports must be placed under the workpiece near the line of cut and near the edge of the workpiece on both sides of the wheel.
- ▶ **Use extra caution when making a "pocket cut" into existing walls or other blind areas.** The protruding wheel may cut gas or water pipes, electrical wiring or objects that can cause kickback.

Safety warnings specific for sanding operations

- ▶ **Do not use excessively oversized sanding disc paper. Follow manufacturers recommendations, when selecting sanding paper.** Larger sanding paper extending beyond the sanding pad presents a laceration hazard and may cause snagging, tearing of the disc, or kickback.

Safety warnings specific for wire brushing operations

- ▶ **Be aware that wire bristles are thrown by the brush even during ordinary operation. Do not overstress the wires by applying excessive load to the brush.** The wire bristles can easily penetrate light clothing and/or skin.
- ▶ **If the use of a guard is recommended for wire brushing, do not allow any interference of the wire wheel or brush with the guard.** Wire wheel or brush may expand in diameter due to work load and centrifugal forces.

Additional Safety and Working Instructions

- ▶ **Observe the mains voltage! The voltage of the power source must correspond with the data on the type plate of the machine.**
- ▶ **Use suitable detectors to determine if utility lines are hidden in the work area or call the local utility company for assistance.** Contact with electric lines can lead to fire and electric shock. Damaging a gas line can lead to explosion. Penetrating a water line causes property damage or may cause an electric shock.
- ▶ **Release the On/Off switch and set it to the off position when the power supply is interrupted, e. g., in case of a power failure or when the mains plug is pulled.** This prevents uncontrolled restarting.

6 | English

- ▶ **Dusts from materials such as lead-containing coatings, some wood types, minerals and metal can be harmful to one's health and cause allergic reactions, lead to respiratory infections and/or cancer.** Materials containing asbestos may only be worked by specialists.
 - As far as possible, use a dust extraction system suitable for the material.
 - Provide for good ventilation of the working place.
 - It is recommended to wear a P2 filter-class respirator.
 Observe the relevant regulations in your country for the materials to be worked.
- ▶ **Prevent dust accumulation at the workplace.** Dusts can easily ignite.
- ▶ **Secure the workpiece.** A workpiece clamped with clamping devices or in a vice is held more secure than by hand.
- ▶ After breakage of the grinding disc during operation or damage to the holding fixtures on the protection guard/power tool, the machine must promptly be sent to an after-sales service agent for maintenance. For addresses, see section "After-sales Service and Application Service".
- ▶ **Adjust protection guard in such a manner that sparking toward the operator is prevented.**
- ▶ **The protection guard may only be turned while actuating the release lever on the gear head. Otherwise, the machine may not continue to be used anymore and must be sent to an after-sales service agent.**
- ▶ **Do not touch grinding and cutting discs before they have cooled down.** The discs can become very hot while working.
- ▶ **Actuate the spindle lock button only when the grinder spindle is at a standstill.** Otherwise, the machine may become damaged.
- ▶ **After mounting the grinding tool and before switching on, check that the grinding tool is correctly mounted and that it can turn freely. Make sure that the grinding tool does not graze against the protection guard or other parts.**
- ▶ **When operating the machine with power from mobile generators, loss of performance or untypical behavior can occur upon switching on.**
- ▶ **By applying too high application force, the machine can be subject to overload. Overload can lead to overheating and damage of the power tool. After heavily straining the power tool, continue to run it at no-load for several minutes in order to cool it down.**
- ▶ **Do not use the power tool with a cut-off stand.**
- ▶ **Never use a cutting disc for roughing.**
- ▶ **The quick-clamping nut may be used only for grinding or cutting discs. Use only a flawless, undamaged quick-clamping nut.**
- ▶ **Do not pull out the gear head while turning it – see figure 12, page 70.**

Products sold in GB only: Your product is fitted with a BS 1363/A approved electric plug with internal fuse (ASTA approved to BS 1362).

If the plug is not suitable for your socket outlets, it should be cut off and an appropriate plug fitted in its place by an authorised customer service agent. The replacement plug should have the same fuse rating as the original plug.















The severed plug must be disposed of to avoid a possible shock hazard and should never be inserted into a mains socket elsewhere.







Products sold in AUS and NZ only: Use a residual current device (RCD) with a rated residual current of 30 mA or less.

Symbols

The following symbols are important for reading and understanding the operating instructions. Please take note of the symbols and their meaning. The correct interpretation of the symbols will help you to use the machine in a better and safer manner.

Symbol	Meaning
	Article number
	Read all safety warnings and all instructions
	Before any work on the machine itself, pull the mains plug from the socket outlet
	Wear protective gloves
	Always wear ear protection.
	Wear safety glasses/goggles
	Movement direction
	Apply strength for the workstep.
	Low speed
	High speed

Symbol	Meaning
	Switching On
	Switching Off
	On/Off switch lock-on
	Releasing the lock-on function of the On/Off switch
	Prohibited action
	Permitted action
	Next step of action
P_1	Rated power input
P_2	Output power
n	Rated speed
n_v	Speed control adjustment
	l = Grinder spindle length d_1 = Grinder spindle diameter
	D = Max. grinding disc diameter d_2 = Inner disc diameter
	Speed preselection
	Constant Electronic Control
	Kickback stop
	Restarting Protection
	Reduced starting current

Symbol	Meaning
	Additional information
	Surface grinding
	Grinding/sanding with sanding sheet
	Weight according to EPTA-Procedure 01:2014 with vibration-damping auxiliary handle
	Weight according to EPTA-Procedure 01:2014 – without auxiliary handle – with auxiliary handle
	Symbol for protection class II (completely insulated)

Delivery Scope

Angle grinder, protection guard, auxiliary handle. Special protection guards, application tools and other accessories shown or described are not part of the standard delivery scope.

A complete overview of accessories can be found in our accessories program.

Intended Use

The machine is intended for roughing metal, stone and ceramic materials and for drilling tiles.

For cutting with bonded abrasives, a special cutting guard (accessory) must be used.

When cutting in stone, provide for sufficient dust extraction. Together with the hand guard (accessory), the machine can be used for brushing and grinding/sanding with elastic sanding plates.

The machine is suitable only for working without water.

Technical Data

The technical data of the machine are listed in the table on page 55 - 56.











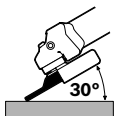

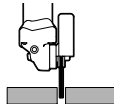

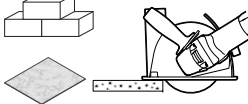

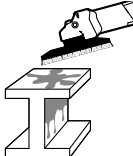

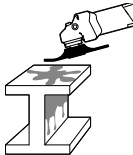

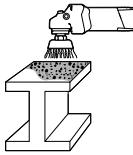
The values given are valid for a nominal voltage [U] of 230 V. For different voltages and models for specific countries, these values can vary.

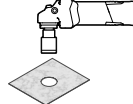

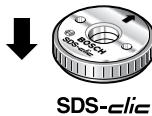



Please observe the article number on the type plate of your machine. The trade names of the individual machines may vary.

Mounting and Operation

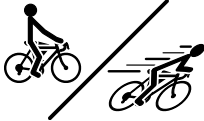
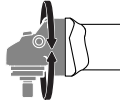
The following table indicates the action objectives for mounting and operation of the power tool. The instructions for each action objective are shown aside. Depending on the type of application, various instruction combinations are required. Observe the safety instructions.

8 | English

Action	Figure	Please observe	Page
Grinding, preparation 	1		57 – 58
Cutting, preparation 	2		59 – 60
Cutting stone, brick and tiles, preparation (recommendation) 	3		61 – 62
Sanding with extraction hood, preparation 	4		63 – 64
Removing paint, preparation 	5		65
Removing rust, preparation 	6		66
Drilling tiles, preparation 	7		67
Mounting the quick-clamping nut 	8		67 – 68
Dismounting the quick-clamping nut 	9		68
Switching On and Off 	10		68

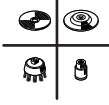
Action	Figure	Please observe	Page
Adjusting the speed preselection		11	69
Rotating the Machine Head		12  	70
Working effectively with the angle grinder		13 	71
Grey-marked area: Handle (insulated gripping surface)		14	71
Selecting the admissible grinding tool		15	72
Selecting Accessories	-		73 - 75

Maintenance and Cleaning

► **For safe and proper working, always keep the machine and ventilation slots clean.**

In extreme conditions, always use dust extraction as far as possible. Blow out ventilation slots frequently and install a residual current device (RCD). When working metals, conductive dust can settle in the interior of the power tool. The total insulation of the power tool can be impaired. Please store and handle the accessory(-ies) carefully.

If the replacement of the supply cord is necessary, this has to be done by Bosch or an authorized Bosch service agent in order to avoid a safety hazard.

After-sales Service and Application Service

Our after-sales service responds to your questions concerning maintenance and repair of your product as well as spare parts. Exploded views and information on spare parts can also be found under:

www.bosch-pt.com

Bosch's application service team will gladly answer questions concerning our products and their accessories.

In all correspondence and spare parts order, please always include the 10-digit article number given on the type plate of the machine.

People's Republic of China China Mainland

Bosch Power Tools (China) Co., Ltd.
567, Bin Kang Road
Bin Jiang District 310052
Hangzhou, P. R. China
Service Hotline: 4008268484
Fax: (0571) 87774502
E-Mail: contact.ptcn@cn.bosch.com
www.bosch-pt.com.cn

HK and Macau Special Administrative Regions

Robert Bosch Hong Kong Co. Ltd.
21st Floor, 625 King's Road
North Point, Hong Kong
Customer Service Hotline: +852 2101 0235
Fax: +852 2590 9762
E-Mail: info@hk.bosch.com
www.bosch-pt.com.hk

Indonesia

PT Robert Bosch
Palma Tower 9th & 10th Floor
Jl. Let. Jend. TB Simatupang II S/06
Jakarta Selatan 12960
Indonesia
Tel.: (021) 3005 6565
Fax: (021) 3005 5801
E-Mail: boschpowertools@id.bosch.com
www.bosch-pt.co.id

10 | 中文**Philippines**

Robert Bosch, Inc.
28th Floor Fort Legend Towers,
3rd Avenue corner 31st Street,
Fort Bonifacio Global City,
1634 Taguig City, Philippines
Tel.: (02) 8703871
Fax: (02) 8703870
matheus.contiero@ph.bosch.com
www.bosch-pt.com.ph

Bosch Service Center:
9725-27 Kamagong Street
San Antonio Village
Makati City, Philippines
Tel.: (02) 8999091
Fax: (02) 8976432
rosalie.dagdagan@ph.bosch.com

Malaysia

Robert Bosch (S.E.A.) Sdn. Bhd.
No. 8A, Jalan 13/6
G.P.O. Box 10818
46200 Petaling Jaya
Selangor, Malaysia
Tel.: (03) 79663194
Fax: (03) 79583838
cheehoe.on@my.bosch.com
Toll-Free: 1800 880188
www.bosch-pt.com.my

Thailand

Robert Bosch Ltd.
Liberty Square Building
No. 287, 11 Floor
Silom Road, Bangrak
Bangkok 10500
Tel.: 02 6393111, 02 6393118
Fax: 02 2384783
Robert Bosch Ltd., P. O. Box 2054
Bangkok 10501, Thailand
www.bosch.co.th

Bosch Service – Training Centre
La Salle Tower Ground Floor Unit No.2
10/11 La Salle Moo 16
Srinakharin Road
Bangkaew, Bang Plee
Samutprakarn 10540
Thailand
Tel.: 02 7587555
Fax: 02 7587525

Singapore

Robert Bosch (SEA) Pte. Ltd.
11 Bishan Street 21
Singapore 573943
Tel.: 6571 2772
Fax: 6350 5315
leongheng.leow@sg.bosch.com
Toll-Free: 1800 3338333
www.bosch-pt.com.sg

Vietnam

Robert Bosch Vietnam Co. Ltd
10/F, 194 Golden Building
473 Dien Bien Phu Street
Ward 25, Binh Thanh District
84 Ho Chi Minh City
Vietnam
Tel.: (08) 6258 3690 ext. 413
Fax: (08) 6258 3692
hieu.lagia@vn.bosch.com
www.bosch-pt.com

Australia, New Zealand and Pacific Islands

Robert Bosch Australia Pty. Ltd.
Power Tools
Locked Bag 66
Clayton South VIC 3169
Customer Contact Center
Inside Australia:
Phone: (01300) 307044
Fax: (01300) 307045
Inside New Zealand:
Phone: (0800) 543353
Fax: (0800) 428570
Outside AU and NZ:
Phone: +61 3 95415555
www.bosch.com.au

Disposal

The machine, accessories and packaging should be sorted for environmental-friendly recycling.

Do not dispose of power tools into household waste!

Subject to change without notice.

中文**电动工具通用安全警告**

警告！ 阅读所有警告和所有说明！不遵照以下警告和说明会导致电击、着火和/或严重伤害。

保存所有警告和说明书以备查阅。

在所有下列的警告中术语“电动工具”指市电驱动（有线）电动工具或电池驱动（无线）电动工具。

工作场地的安全

- ▶ **保持工作场地清洁和明亮。** 混乱和黑暗的场地会引发事故。
- ▶ **不要在易爆环境，如有易燃液体、气体或粉尘的环境下操作电动工具。** 电动工具产生的火花会点燃粉尘或气体。
- ▶ **让儿童和旁观者离开后操作电动工具。** 注意力不集中会使操作者失去对工具的控制。

电气安全

- ▶ **电动工具插头必须与插座相配。绝不能以任何方式改装插头。需接地的电动工具不能使用任何转换插头。** 未经改装的插头和相配的插座将减少电击危险。
- ▶ **避免人体接触接地表面，如管道、散热片和冰箱。** 如果你身体接地会增加电击危险。
- ▶ **不得将电动工具暴露在雨中或潮湿环境中。** 水进入电动工具将增加电击危险。
- ▶ **不得滥用电线。绝不能用电线搬运、拉动电动工具或拔出其插头。使电线远离热源、油、锐边或运动部件。** 受损或缠绕的软线会增加电击危险。
- ▶ **当在户外使用电动工具时，使用适合户外使用的外接软线。** 适合户外使用的软线将减少电击危险。
- ▶ **如果在潮湿环境下操作电动工具是不可避免的，应使用剩余电流动作保护器 (RCD)。** 使用 RCD 可减少电击危险。

人身安全

- ▶ **保持警觉，当操作电动工具时关注所从事的操作并保持清醒。当你感到疲倦，或在有药物、酒精或治疗反应时，不要操作电动工具。** 在操作电动工具时瞬间的疏忽会导致严重人身伤害。
- ▶ **使用个人防护装置。始终佩戴护目镜。** 安全装置，诸如适当条件下使用防尘面具、防滑安全鞋、安全帽、听力防护等装置能减少人身伤害。
- ▶ **防止意外启动。确保开关在连接电源和 / 或电池盒、拿起或搬运工具时处于关断位置。** 手指放在已接通电源的开关上或开关处于接通时插入插头可能会导致危险。
- ▶ **在电动工具接通之前，拿掉所有调节钥匙或扳手。** 遗留在电动工具旋转零件上的扳手或钥匙会导致人身伤害。
- ▶ **手不要伸展得太长。时刻注意立足点和身体平衡。** 这样在意外情况下能很好地控制电动工具。
- ▶ **着装适当。不要穿宽松衣服或佩戴饰品。让衣服、手套和头发远离运动部件。** 宽松衣服、佩饰或长发可能会卷入运动部件中。
- ▶ **如果提供了与排屑、集尘设备连接用的装置，要确保他们连接完好且使用得当。** 使用这些装置可减少尘屑引起的危险。

电动工具使用和注意事项

- ▶ **不要滥用电动工具，根据用途使用适当的电动工具。** 选用适当设计的电动工具会使你工作更有效、更安全。
- ▶ **如果开关不能接通或关断工具电源，则不能使用该电动工具。** 不能用开关来控制的电动工具是危险的且必须进行修理。

- ▶ **在进行任何调节、更换附件或贮存电动工具之前，必须从电源上拔掉插头和 / 或使电池盒与工具脱开。** 这种防护性措施将减少工具意外起动的危险。
- ▶ **将闲置不用的电动工具贮存在儿童所及范围之外，并且不要让不熟悉电动工具或对这些说明不了解的人操作电动工具。** 电动工具在未经培训的用户手中是危险的。
- ▶ **保养电动工具。检查运动件是否调整到位或卡住，检查零件破损情况和影响电动工具运行的其他状况。** 如有损坏，电动工具应在使用前修理好。许多事故由维护不良的电动工具引发。
- ▶ **保持切削刀具锋利和清洁。** 保养良好的有锋利切削刃的刀具不易卡住而且容易控制。
- ▶ **按照使用说明书，考虑作业条件和进行的作业来使用电动工具、附件和工具的刀头等。** 将电动工具用于那些与其用途不符的操作可能会导致危险。

维修

- ▶ **将你的电动工具送交专业维修人员，使用同样的备件进行修理。** 这样将确保所维修的电动工具的安全性。

针对角磨机的安全规章

砂磨、砂光、钢丝砂光或砂磨切割操作的通用安全警告

- ▶ **该电动工具是实现砂轮机、砂光机、钢丝刷或切断工具功能的。阅读随该电动工具提供的所有安全警告、说明、图解和规定。** 不了解以下所列所有说明将导致电击、着火和 / 或严重伤害。
- ▶ **不推荐用该电动工具进行抛光。** 电动工具不按指定的功能去操作，可能发生危险和引起人身伤害。
- ▶ **不使用非工具制造商推荐和专门设计的附件。** 否则该附件可能被装到你的电动工具上，而它不能保证安全操作。
- ▶ **附件的额定速度必须至少等于电动工具上标出的最大速度。** 附件以比其额定速度大的速度运转会发生爆裂和飞溅。
- ▶ **附件的外径和厚度必须在电动工具额定能力范围之内。** 不正确的附件尺寸不能得到充分防护或控制。
- ▶ **砂轮、法兰盘、靠背垫或任何其他附近的轴孔尺寸必须适合于安装到电动工具的主轴上。** 带轴孔的、与电动工具安装件不配的附件将会失稳、过度振动并会引起失控。
- ▶ **不要使用损坏的附件。在每次使用前要检查附件，例如砂轮是否有碎片和裂缝，靠背垫是否有裂缝，撕裂或过度磨损，钢丝刷是否松动或金属丝是否断裂。如果电动工具或附件跌落了，检查是否有损坏或安装没有损坏的附件。检查和安装附件后，让自己和旁观者的位置远离旋转附件的平面，并以电动工具最大空载**

12 | 中文

速度运行 1 分钟。损坏的附件通常在该试验时会碎裂。

- ▶ **戴上防护用品。**根据适用情况，使用面罩，安全护目镜或安全眼镜。适用时，戴上防尘面具，听力保护器，手套和能挡小磨料或工件碎片的工作围裙。眼防护罩必须挡住各种操作产生的飞屑。防尘面具或口罩必须能够过滤操作产生的颗粒。长期暴露在高强度噪音中会引起失聪。
- ▶ **让旁观者与工作区域保持一安全距离。**任何进入工作区域的人必须戴上防护用品。工件或破损附件的碎片可能会飞出并引起紧靠着操作区域的旁观者的伤害。切割附件触及带电导线会使电动工具外露的金属零件带电，并使操作者触电。
- ▶ **当在切割附件有可能切割到暗线或自身电缆的场所进行操作时，只能通过绝缘握持面来握住电动工具。**切割附件碰到一根带电导线可能会使电动工具外露的金属零件带电并使操作者发生电击危险。
- ▶ **使软线远离旋转的附件。**如果控制不当，软线可能被切断或缠绕，并使得你的手或手臂可能被卷入旋转附件中。
- ▶ **直到附件完全停止运动才放下电动工具。并且不得使用任何外力迫使金刚石切割片停转。**旋转的附件可能会抓住表面并拉动电动工具而让你失去对工具的控制。
- ▶ **当携带电动工具时不要开动它。**意外地触及旋转附件可能会缠绕你的衣服而使附件伤害身体。
- ▶ **经常清理电动工具的通风口。**电动机风扇会将灰尘吸进机壳，过多的金属粉末沉积会导致电气危险。
- ▶ **不要在易燃材料附近操作电动工具。**火星可能会点燃这些材料。
- ▶ **不要使用需用冷却液的附件。**用水或其他冷却液可能导致电腐蚀或电击。

反弹和相关警告

- ▶ **反弹是因卡住或缠绕住的旋转砂轮，靠背垫，钢丝刷或其他附件而产生的突然反作用力。**卡住或缠绕会引起旋转附件的迅速堵转，随之使失控的电动工具在卡住点产生与附件旋转方向相反的运动。例如，如果砂轮被工件缠绕或卡住了，伸入卡住点的砂轮边缘可能会进入材料表面而引起砂轮爬出或反弹。砂轮可能飞向或飞离操作者，这取决于砂轮在卡住点的运动方向。在此条件下砂轮也可能碎裂。反弹是电动工具误用和 / 或不正确操作工序或条件的结果。可以通过采取以下给出的适当预防措施得以避免。
- ▶ **保持紧握电动工具，使你的身体和手臂处于正确状态以抵抗反弹力。**如有辅助手柄，则要一直使用，以便最大限度控制住起动时的反弹力或反力矩。如采取合适的预防措施，操作者就可以控制反力矩或反弹力。
- ▶ **绝不能将手靠近旋转附件。**附件可能会反弹碰到手。

- ▶ **不要站在发生反弹时电动工具可能移动到的地方。**反弹将在缠绕点驱使工具逆砂轮运动方向运动。
- ▶ **当在尖角、锐边等处作业时要特别小心。**避免附件的弹跳和缠绕。尖角、锐边和弹跳具有缠绕旋转附件的趋势并引起反弹的失控。
- ▶ **不要附装上锯链、木雕刀片或带齿锯片。**这些锯片会产生频繁的反弹和失控。

对磨削和砂磨切割操作的专用安全警告

- ▶ **只使用所推荐的砂轮型号和为选用砂轮专门设计的护罩。**不是为电动工具设计的砂轮不能充分得到防护，是不安全的。
- ▶ **安装弯曲的砂轮时，砂轮的研磨面不可以突出于防护罩缘之外。**防护罩无法遮蔽因为安装不当而突出于防护罩缘之外的砂轮。
- ▶ **防护必须牢固地装在电动工具上，且放置得最具安全性，只有最小的砂轮部分暴露在操作人面前。**护罩帮助操作者免于受到爆裂砂轮片和偶然触及砂轮的危险。
- ▶ **砂轮只用作推荐的用途。例如：不要用切割砂轮的侧面进行磨削。**施加到砂轮侧面的力可能会使其碎裂。
- ▶ **始终为所选砂轮选用未损坏的，有恰当规格和形状的砂轮法兰盘。**合适的砂轮法兰盘支承砂轮可以减小砂轮破裂的可能性。切割砂轮的法兰盘可以不同于砂轮法兰盘。
- ▶ **不要使用从大规格电动工具上用剩的磨损砂轮。**用于大规格电动工具上的砂轮不适用于较小规格工具的高速工况并可能会爆裂。

对砂轮切割操作的附加专用安全警告

- ▶ **不要“夹”住切割砂轮或施加过大的压力。不要试图做过深的切割。**给砂轮施加过应力增加了砂轮在切割时的负载，容易缠绕或卡住，增加了反弹或砂轮爆裂的可能性。
- ▶ **身体不要对着旋转砂轮，也不要站在其后。**当把砂轮从操作者身边的操作点移开时，可能的反弹会使旋转砂轮和电动工具朝你推来。
- ▶ **当砂轮被卡住或无论任何原因而中断切割时，关掉电动工具并握住工具不要动，直到砂轮完全停止。决不要试图当砂轮仍然运转时使切割砂轮脱离切割，否则会发生反弹。**调查并采取校正措施以消除砂轮卡住的原因。
- ▶ **不能在工件上重新启动切割操作。让砂轮达到全速后再小心地重新进入切割。**如果电动工具在工件上重新启动，砂轮可能会卡住、爬出或反弹。
- ▶ **支撑住板材或超大工件可使得砂轮卡住和反弹的危险降到最低限度。**大工件凭借自重而下垂。必须在工件靠近切割线处和砂轮两侧近工件边缘处放置支承。

- ▶ 当进行“盲切割”进入墙体或其他盲区时要格外小心。伸出的砂轮可能会割到煤气管或水管，电线或由此引起反弹的物体。

砂光操作的专用安全警告

- ▶ 当砂光时，不要使用超大砂盘纸。选用砂盘纸时应按照制造商的推荐。超出砂光垫盘的大砂盘纸有撕裂的危险并且会引起缠绕、砂盘的撕裂或反弹。

钢丝刷操作的专用安全警告

- ▶ 要意识到即使正常操作时钢丝线也会从刷子甩出。不要对钢丝刷施加过大的负荷而使得钢丝线承受过应力。钢丝线可能会轻易刺入薄的衣服和 / 或皮肤内。
- ▶ 如果建议钢丝刷使用护罩，则不允许该护罩对钢丝轮或钢丝刷有任何干扰。钢丝轮或钢丝刷在工作负荷和离心力作用下直径会变大。

进一步的安全规章和工作指示

- ▶ 注意电源的电压！电源的电压必须和电动工具铭牌上标示的电压一致。
- ▶ 使用合适的侦测装置侦察隐藏的电线，或者向当地的相关单位寻求支援。接触电线可能引起火灾并让操作者触电。损坏了瓦斯管会引起爆炸。凿穿水管不仅会造成严重的财物损失，也可能导致触电。
- ▶ 如果电源突然中断，例如停电或不小心中断，得马上解除起停开关的锁定并把它设定在关闭的位置。这样可以避免机器突然起动。
- ▶ 含铅的颜料以及某些木材、矿物和金属的加工废尘有害健康、可能造成过敏、让操作者感染呼吸道疾病和 / 或罹患癌症。只有经过专业训练的人员才能够加工含石棉的物料。
 - 尽可能使用适合物料的吸尘装置。
 - 工作场所要保持空气流通。
 - 最好佩戴 P2 滤网等级的口罩。
 请留心并遵守贵国和加工物料有关的法规。
- ▶ 避免让工作场所堆积过多的尘垢。尘垢容易被点燃。
- ▶ 固定好工件。使用固定装置或老虎钳固定工件，会比用手持握工件更牢固。
- ▶ 如果研磨片在工作中途断裂了，或者防护罩上 / 电动工具上的接头损坏了，务必即刻将电动工具交给客户服务处修理。地址可以参考“客户服务处和顾客咨询中心”。
- ▶ 调整防护罩，让它能够挡住朝着操作者喷射的火花。
- ▶ 防护罩必须在按下传动壳上的解锁开关后，才能够被转动，如果不是如此则千万不可以继续使用电动工具，必须把它交给客户服务处检视。
- ▶ 在研磨 / 割片尚未冷却之前，切勿紧握研磨 / 割片。工作时切割片会变得非常炙热。

- ▶ 待主轴完全静止后，才可以使用主轴锁定键。否则可能会损坏电动工具。
- ▶ 在安装好磨具且尚未开动机器之前，必须检查磨具是否正确地装牢了，磨具能否自由无阻地旋转。务必确定磨具转动时不会和防护罩或其它的机件产生摩擦。
- ▶ 如果把电动工具连接在活动的电源上（例如发电机），在开动机器时可能会发生功能减弱或一些不寻常的现象。
- ▶ 操作机器时如果施压过重可能导致电动工具过载。过载会让电动工具超温并损坏电动工具。在电动工具承受重荷之后，要让它空转数分钟以便冷却电动工具。
- ▶ 不可以把电动工具安装在切割研磨架上操作。
- ▶ 勿使用切割片进行粗磨作业。
- ▶ 快速固定螺母只能和研磨 / 分割片一起使用。只能使用完好、无损的快速固定螺母。
- ▶ 拧转时不可以抽出传动壳 - 参考图 12，页数 70。

代表符号

以下的符号可以帮助您正确地使用本机器。请详细阅读各符号及它们的代表意思。正确了解各符号所代表的意义，可以帮助您更有把握更安全地操作本机器。

符号	含义
	物品代码
	阅读所有的安全规章和说明
	在电动工具上进行任何修护工作之前必须从电源插座上拔出插头
	佩戴防护手套
	请佩戴耳罩
	请佩戴护目镜
	移动方向

14 | 中文

符号	含义
	进行这个工作步骤时得使劲
	低转速
	高转速
I	开动
O	关闭
	锁定起停开关
	解开起停开关的锁定
	禁止的行为
	允许的动作
	下一个处理步骤
P_1	额定输入功率
P_2	输出功率
n	额定转速
n_v	转速设定范围
	l = 研磨主轴的长度 d_1 = 研磨主轴的直径
	D = 最大研磨片直径 d_2 = 研磨片内直径
	设定转速
	恒定电子装置
	恒定电子装置
KICK BACK STOP	回击 - 关闭功能
	防止再起启动装置
	起动电流限制装置

符号	含义
	附加资讯
	表面研磨
	使用砂纸研磨
	重量符合 EPTA-Procedure 01:2014 使用减震辅助手柄
	重量符合 EPTA-Procedure 01:2014 使用标准辅助手柄
	绝缘等级 II 的代表符号 (完全绝缘)

供货范围

角磨机, 防护罩, 辅助手柄。
特殊防护罩, 安装工具和其它出现在插图或被提及的附件不包含在基本的供货范围。
在本公司的附件清单中标列了完整的附件。

按照规定使用机器

本电动工具适合在金属、石材和陶瓷料上进行粗磨, 以及在瓷砖上钻孔。
使用结合磨料进行分割时, 必须在机器上安装针对分割的特殊防护罩。
分割石材时要使用合适的吸尘装备。
安装了护手装置 (附件) 后, 本电动工具也可以安装钢丝刷进行刷磨以及使用弹性磨盘研磨。
本电动工具只适合进行干式加工。

技术数据











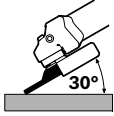

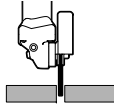

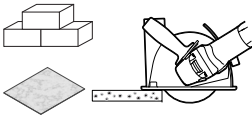

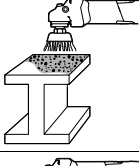

本产品的技术数据列在本使用说明书 55 - 56 页的表格中。

本说明书提供的参数是以 230 V 为依据, 於低电压地区, 此数据有可能不同。

请认清电动工具铭牌上的物品代码。电动工具在销售市场上没有统一的商品名称。

安装和操作

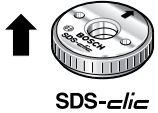
以下表格显示了在安装和使用电动工具时的执行目的。表格中的图形显示了与执行目的相关的提示。因为用途不同所以会有不同的提示组合。请留心安全规章。

执行目的	图片	请注意	页数
准备研磨			57 - 58
准备分割			59 - 60
准备分割石材和瓷砖 (建议)			61 - 62
准备使用吸尘罩研磨			63 - 64
准备磨除颜料			65
准备磨除锈迹			66
准备在瓷砖上钻孔			67
安装快速固定螺母			67 - 68
拆卸快速固定螺母			68

16 中文			
执行目的	图片	请注意	页数
开动 / 关闭		10	68
调整转速		11	69
旋转机头		12	70
使用角磨机有效地工作		13	71
打上灰色记号的部位：手柄 (绝缘的握持位置)		14	71
选择许可的磨具		15	72
选择附件	-	-	73 - 75

维修和清洁

- ▶ **电动工具和通风间隙都必须保持清洁，这样才能提高工作品质和安全性。**

在某些极端的操作环境下，如果可能的话一定要使用吸尘装备。吹除通气孔中的污垢并且要使用剩余电流 - (FI) - 保护开关。加工金属时可能在电动工具的内部堆积会导电的废尘。这样可能会影响电动工具的安全绝缘性能。

小心地保存和使用附件。

如果必须更换连接线，务必把这项工作交给博世或者授权的博世电动工具客户服务执行，以避免危害机器的安全性能。

顾客服务处和顾客咨询中心

本公司顾客服务处负责回答有关本公司产品的修理，维护和备件的问题。以下的网页中有爆炸图和备件的资料：
www.bosch-pt.com

博世顾客咨询团队非常乐意为您解答有关本公司产品及附件的问题。

询问和订购备件时，务必提供机器铭牌上标示的 10 位数字物品代码。

有关保证，维修或更换零件事宜，请向合格的经销商查询。

中国大陆

博世电动工具（中国）有限公司
中国 浙江省 杭州市
滨江区滨康路 567 号
邮政编码：310052
免费服务热线：4008268484
传真：(0571) 87774502
电邮：contact.ptcn@cn.bosch.com
www.bosch-pt.com.cn

罗伯特·博世有限公司
香港北角英皇道 625 号 21 楼
客户服务热线：+852 2101 0235
传真：+852 2590 9762
电邮：info@hk.bosch.com
网站：www.bosch-pt.com.hk

制造商地址: Robert Bosch Power Tools GmbH
 罗伯特·博世电动工具有限公司
 70538 Stuttgart / GERMANY
 70538 斯图加特 / 德国

处理废弃物

必须以符合环保的方式，回收再利用损坏的机器、附件和废弃的包装材料。

不可以把电动工具丢入家庭垃圾中！

保留修改权。

中文

電動工具通用安全警告

警告 閱讀所有警告和所有說明。不遵照以下警告和說明會導致電擊、着火和/或嚴重傷害。

保存所有警告和說明書以備查閱。

在所有下列的警告中術語“電動工具”指市電驅動（有線）電動工具或電池驅動（無線）電動工具。

工作場地的安全

- ▶ 保持工作場地清潔和明亮。混亂和黑暗的場地會引發事故。
- ▶ 不要在易爆環境，如有易燃液體、氣體或粉塵的環境下操作電動工具。電動工具產生的火花會點燃粉塵或氣體。
- ▶ 讓兒童和旁觀者離開後操作電動工具。注意力不集中會使你失去對工具的控制。

電氣安全

- ▶ 電動工具插頭必須與插座相配。絕不能以任何方式改裝插頭。需接地的電動工具不能使用任何轉換插頭。未經改裝的插頭和相配的插座將減少電擊危險。
- ▶ 避免人體接觸接地表面，如管道、散熱片和冰箱。如果你身體接地會增加電擊危險。
- ▶ 不得將電動工具暴露在雨中或潮濕環境中。水進入電動工具將增加電擊危險。
- ▶ 不得濫用電線。絕不能用電線搬運、拉動電動工具或拔出其插頭。使電線遠離熱源、油、銳邊或運動部件。受損或纏繞的軟線會增加電擊危險。
- ▶ 當在戶外使用電動工具時，使用適合戶外使用的外接軟線。適合戶外使用的軟線，將減少電擊危險。
- ▶ 如果在潮濕環境下操作電動工具是不可避免的，應使用剩餘電流動作保護器（RCD）。使用 RCD 可減小電擊危險。

人身安全

- ▶ 保持警覺，當操作電動工具時關注所從事的操作並保持清醒。當你感到疲倦，或在有藥物、酒精或治療反應時，不要操作電動工具。在操作電動工具時瞬間的疏忽會導致嚴重人身傷害。
- ▶ 使用個人防護裝置。始終佩戴防護目鏡。安全裝置，諸如適當條件下使用防塵面具、防滑安全鞋、安全帽、聽力防護等裝置能減少人身傷害。
- ▶ 防止意外起動。確保開關在連接電源和/或電池盒、拿起或搬運工具時處於關斷位置。手指放在已接通電源的開關上或開關處於接通時插入插頭可能會導致危險。
- ▶ 在電動工具接通之前，拿掉所有調節鑰匙或扳手。遺留在電動工具旋轉零件上的扳手或鑰匙會導致人身傷害。
- ▶ 手不要伸展得太長。時刻注意立足點和身體平衡。這樣在意外情況下能很好地控制電動工具。
- ▶ 著裝適當。不要穿寬鬆衣服或佩戴飾品。讓你的衣服、手套和頭髮遠離運動部件。寬鬆衣服、佩飾或長髮可能會捲入運動部件中。
- ▶ 如果提供了與排屑、集塵設備連接用的裝置，要確保他們連接完好且使用得當。使用這些裝置可減少塵屑引起的危險。

電動工具使用和注意事項

- ▶ 不要濫用電動工具，根據用途使用適當的電動工具。選用適當設計的電動工具會使你工作更有效、更安全。
- ▶ 如果開關不能接通或關斷工具電源，則不能使用該電動工具。不能用開關來控制的電動工具是危險的且必須進行修理。
- ▶ 在進行任何調節、更換附件或貯存電動工具之前，必須從電源上拔掉插頭和/或使電池盒與工具脫開。這種防護性措施將減少工具意外起動的危險。
- ▶ 將閒置不用的電動工具貯存在兒童所及範圍之外，並且不要讓不熟悉電動工具或對這些說明不瞭解的人操作電動工具。電動工具在未經培訓的用戶手中是危險的。
- ▶ 保養電動工具。檢查運動件是否調整到位或卡住，檢查零件破損情況和影響電動工具運行的其他狀況。如有損壞，電動工具應在使用前修理好。許多事故由維護不良的電動工具引發。
- ▶ 保持切削刀具鋒利和清潔。保養良好的有鋒利切削刃的刀具不易卡住而且容易控制。
- ▶ 按照使用說明書，考慮作業條件和進行的作業來使用電動工具、附件和工具的刀頭等。將電動工具用於那些與其用途不符的操作可能會導致危險。

18 | 中文

檢修

- ▶ 將你的電動工具送交專業維修人員，必須使用同樣的備件進行更換。這樣將確保所維修的電動工具的安全性。

針對角磨機的安全規章**砂磨、砂光、鋼絲砂光或砂磨切割操作的通用安全警告**

- ▶ 該電動工具是用於實現砂輪機、砂光機、鋼絲刷或切斷工具功能的。閱讀隨該電動工具提供的所有安全警告、說明、圖解和規定。不了解以下所列所有說明將導致電擊、著火和 / 或嚴重傷害。
- ▶ 不推薦用該電動工具進行拋光。電動工具不按指定的功能去操作，可能發生危險和引起人身傷害。
- ▶ 不使用非工具製造商推薦和專門設計的附件。否則該附件可能被裝到你的電動工具上，而它不能保證安全操作。
- ▶ 附件的額定速度必須至少等於電動工具上標出的最大速度。附件以比其額定速度大的速度運轉會發生爆裂和飛濺。
- ▶ 附件的外徑和厚度必須在電動工具額定能力範圍之內。不正確的附件尺寸不能得到充分防護或控制。
- ▶ 安裝件如果配備了螺紋插柄，插柄上的螺紋必須和主軸上的螺紋準確接合。安裝時必須借助法蘭的安裝件，該安裝件上的孔直徑必須和法蘭的接頭直徑吻合。如果無法將安裝件準確地固定在電動工具上，不僅安裝件無法均勻旋轉，旋轉時會強烈震動並且會造成操作失控。
- ▶ 不要使用損壞的附件。在每次使用前要檢查附件，例如砂輪是否有碎片和裂縫，靠背墊是否有裂縫，撕裂或過度磨損，鋼絲刷是否鬆動或金屬絲是否斷裂。如果電動工具或附件跌落了，檢查是否有損壞或安裝沒有損壞的附件。檢查和安裝附件後，讓自己和旁觀者的位置遠離旋轉附件的平面，並以電動工具最大空載速度運行 1 分鐘。損壞的附件通常在該試驗時會碎裂。
- ▶ 戴上防護用品。根據適用情況，使用面罩，安全護目鏡或安全眼鏡。適用時，戴上防塵面具，聽力保護器，手套和能擋小磨料或工件碎片的工作圍裙。眼防護罩必須擋住各種操作產生的飛屑。防塵面具或口罩必須能夠過濾操作產生的顆粒。長期暴露在強強度噪音中會引起失聰。
- ▶ 讓旁觀者與工作區域保持一安全距離。任何進入工作區域的人必須戴上防護用品。工件或破損附件的碎片可能會飛出並引起緊靠著操作區域的旁觀者的傷害。切割附件觸及帶電導線會使電動工具外露的金屬零件帶電，並使操作者觸電。
- ▶ 當在切割附件有可能切割到暗線或自身電線的場所進行操作時，只能通過絕緣握持面來握住電動工具。切

割附件碰到一根帶電導線會使電動工具外露的金屬零件帶電並使操作者發生電擊危險。

- ▶ 使軟線遠離旋轉的附件。如果控制不當，軟線可能被切斷或纏繞，並使得你的手或手臂可能被卷入旋轉附件中。
- ▶ 直到附件完全停止運動才放下電動工具。並且不得使用任何外力迫使金剛石切割片停轉。旋轉的附件可能會抓住表面並拉動電動工具而讓你失去對工具的控制。
- ▶ 當攜帶電動工具時不要開動它。意外地觸及旋轉附件可能會纏繞你的衣服而使附件傷害身體。
- ▶ 經常清理電動工具的通風口。電動機風扇會將灰塵吸進機殼，過多的金屬粉末沉積會導致電氣危險。
- ▶ 不要在易燃材料附近操作電動工具。火星可能會點燃這些材料。
- ▶ 不要使用需用冷卻液的附件。用水或其他冷卻液可能導致電腐蝕或電擊。

反彈和相關警告

- ▶ 反彈是因卡住或纏繞住的旋轉砂輪，靠背墊，鋼絲刷或其他附件而產生的突然反作用力。卡住或纏繞會引起旋轉附件的迅速堵轉，隨之使失控的電動工具在卡住點產生與附件旋轉方向相反的運動。例如，如果砂輪被工件纏繞或卡住了，伸入卡住點的砂輪邊緣可能會進入材料表面而引起砂輪爬出或反彈。砂輪可能飛向或飛離操作者，這取決於砂輪在卡住點的運動方向。在此條件下砂輪也可能碎裂。反彈是電動工具誤用和 / 或不正確操作工序或條件的結果。可以通過採取以下給出的適當預防措施得以避免。
- ▶ 保持緊握電動工具，使你的身體和手臂處於正確狀態以抵抗反彈力。如有輔助手柄，則要一直使用，以便最大限度控制住起動時的反彈力或反力矩。如採取合適的預防措施，操作者就可以控制反力矩或反彈力。
- ▶ 絕不能將手靠近旋轉附件。附件可能會反彈碰到手。
- ▶ 不要站在發生反彈時電動工具可能移動到的地方。反彈將在纏繞點驅使工具逆砂輪運動方向運動。
- ▶ 當在尖角，銳邊等處作業時要特別小心。避免附件的彈跳和纏繞。尖角，銳邊和彈跳具有纏繞旋轉附件的趨勢並引起反彈的失控。
- ▶ 不要安裝上鋸鏈，木雕刀片或帶齒鋸片。這些鋸片會產生頻繁的反彈和失控。

對磨削和砂磨切割操作的專用安全警告

- ▶ 只使用所推薦的砂輪型號和為選用砂輪專門設計的護罩。不是為電動工具設計的砂輪不能充分得到防護，是不安全的。
- ▶ 安裝彎曲的砂輪時，砂輪的研磨面不可以突出於防護罩緣之外。防護罩無法遮蔽因為安裝不當而突出於防護罩緣之外的砂輪。

- ▶ 防護罩必須牢固地裝在電動工具上，並且被調整在最具安全性的位置，只能有最小部分的砂輪暴露在操作人前面。防護罩能夠保護操作者免受到爆裂砂輪碎片割傷，避免操作者偶然觸及砂輪以及火花點燃衣物等的危險。
- ▶ 砂輪只用作推薦的用途。例如：不要用切割砂輪的側面進行磨削。施加到砂輪側面的力可能會使其碎裂。
- ▶ 始終為所選砂輪選用未損壞的，有恰當規格和形狀的砂輪法蘭盤。合適的砂輪法蘭盤支撐砂輪可以減小砂輪破裂的可能性。切割砂輪的法蘭盤可以不同于砂輪法蘭盤。
- ▶ 不要使用從大規格電動工具上用剩的磨損砂輪。用于大規格電動工具上的砂輪不適用于較小規格工具的高速工況並可能會爆裂。

對砂輪切割操作的附加專用安全警告

- ▶ 不要“夾”住切割砂輪或施加過大的壓力。不要試圖做過深的切割。給砂輪施加過應力增加了砂輪在切割時的負載，容易纏繞或卡住，增加了反彈或砂輪爆裂的可能性。
- ▶ 身體不要對著旋轉砂輪，也不要站在其後。當把砂輪從操作者身邊的操作點移開時，可能的反彈會使旋轉砂輪和電動工具朝你推來。
- ▶ 當砂輪被卡住或無論任何原因而中斷切割時，關掉電動工具並握住工具不要動，直到砂輪完全停止。決不要試圖當砂輪仍然旋轉時使切割砂輪脫離切割，否則會發生反彈。調查並採取校正措施以消除砂輪卡住的原因。
- ▶ 不得在切割片與工件接觸的情況下啟動切割機，不能在工件上重新啟動切割操作。讓砂輪達到全速後再小心地重新進入切割。如果電動工具在工件上重新啟動，砂輪可能會卡住，爬出或反彈。
- ▶ 支撐住板材或超大工件可使得砂輪卡住和反彈的危險降到最低限度。大工件憑借自重而下垂。必須在工件靠近切割線處和砂輪兩側近工件邊緣處放置支承。
- ▶ 當進行“盲切割”進入牆體或其他盲區時要格外小心。伸出的砂輪可能會割到煤氣管或水管，電線或由此引起反彈的物體。

砂光操作的專用安全警告

- ▶ 當砂光時，不要使用超大砂盤紙。選用砂盤紙時應按照製造商的推薦。超出砂光墊盤的大砂盤紙有撕裂的危險並且會引起纏繞、砂盤的撕裂或反彈。

鋼絲刷操作的專用安全警告

- ▶ 要意識到即使正常操作時鋼絲線也會從刷子甩出。不要對鋼絲刷施加過大的負荷而使得鋼絲線承受過應力。鋼絲線可能會輕易刺入薄的衣服和 / 或皮膚內。
- ▶ 如果建議鋼絲刷使用護罩，則不允許該護罩對鋼絲輪或鋼絲刷有任何干擾。鋼絲輪或鋼絲刷在工作負荷和離心力作用下直徑會變大。

進一步的安全規章和工作指示

- ▶ 注意電源的電壓！電源的電壓必須和電動工具銘牌上標示的電壓一致。
- ▶ 使用合適的偵測裝置偵察隱藏的電線，或者向當地的相關單位尋求支援。接觸電線可能引起火災並讓操作者觸電。損壞了瓦斯管會引起爆炸。鑿穿水管不僅會造成嚴重的財物損失，也可能導致觸電。
- ▶ 如果電源突然中斷，例如停電或不小心中斷，得馬上解除起停開關的鎖定，並把它設定在關閉的位置。這樣可以避免機器突然再起動而造成失控。
- ▶ 含鉛的顏料以及某些木材、礦物和金屬的加工廢塵有害健康、可能造成過敏、讓操作者感染呼吸道疾病和 / 或癌症。只有經過專業訓練的人員才能夠加工含石棉的物料。
 - 盡可能使用適合物料的吸塵裝置。
 - 工作場所要保持空氣流通。
 - 最好佩戴 P2 濾網等級的口罩。
 請留心並遵守貴國和加工物料有關的法規。
- ▶ 避免讓工作場所堆積過多的塵垢。塵埃容易被點燃。
- ▶ 固定好工件。使用固定裝置或老虎鉗固定工件，會比用手持握工件更牢固。
- ▶ 如果研磨片在工作中途斷裂了，或者防護罩上 / 電動工具上的接頭損壞了，務必即刻將電動工具交給顧客服務處修理。地址可以參考“顧客服務處和顧客諮詢中心”。
- ▶ 調整防護罩，讓它能夠擋住朝著操作者噴射的火花。
- ▶ 防護罩必須在按下傳動殼上的解鎖開關後，才能夠被轉動，如果不是如此則千萬不可以繼續使用電動工具，必須把它交給顧客服務處檢視。
- ▶ 在研磨 / 割片尚未冷卻之前，切勿握持研磨 / 割片。工作時切割片會變得非常炙熱。
- ▶ 待主軸完全靜止后，才可以使主軸鎖定鍵。否則可能會損壞電動工具。
- ▶ 在安裝好磨具且尚未開動機器之前，必須檢查磨具是否正確地裝牢了，磨具能否自由無阻地旋轉。務必確定磨具轉動時不會和防護罩或其它的機件產生磨擦。
- ▶ 如果把電動工具連接在活動的電源上（例如發電機），在開動機器時可能會發生功能減弱或一些不尋常的現象。
- ▶ 操作機器時如果施壓過重可能導致電動工具過載。過載會讓電動工具超溫並損壞電動工具。在電動工具承受重荷之後，要讓它空轉數分鐘以便利冷卻電動工具。
- ▶ 不可以把電動工具安裝在切割研磨架上操作。
- ▶ 勿使用切割片進行粗磨作業。
- ▶ 快速固定螺母只能和研磨 / 分割片一起使用。只能使用完好、無損的快速固定螺母。
- ▶ 擰轉時不可以抽出傳動殼 - 參考圖 12，頁數 70。

20 | 中文

代表符號

以下的符號可以幫助您正確地使用本機器。請詳細閱讀各符號及它們的代表意思。正確了解各符號所代表的意義，可以幫助您更有把握更安全地操作本機器。

符號	含義
	物品代碼
	閱讀所有的安全規章和說明
	在電動工具上進行任何修護工作之前必須從電源插座上拔出插頭
	佩戴防護手套
	請佩戴耳罩
	請佩戴護目鏡。
	移動方向
	進行這個工作步驟時得使勁
	低轉速
	高轉速
I	開動
O	關閉
	鎖定起停開關
	解開起停開關的鎖定
	禁止的行為
	允許的動作

符號	含義
	下一個處理步驟
P_1	額定輸入功率
P_2	輸出功率
n	額定轉速
n_v	轉速設定範圍
	l = 研磨主軸的長度 d_1 = 研磨主軸的直徑
	D = 最大研磨片直徑 d_2 = 研磨片內直徑
	設定轉速
	恆定電子裝置
KICK BACK STOP	回擊 - 關閉功能
	防止再起動裝置
	起動電流限制裝置
i+	附加資訊
	表面研磨
	使用砂紙研磨
	重量符合 EPTA-Procedure 01:2014 使用減震輔助手柄
	重量符合 EPTA-Procedure 01:2014 使用標準輔助手柄
	絕緣等級 II 的代表符號 (完全絕緣)

供貨範圍

角磨機，防護罩，輔助手柄。
特殊防護罩，安裝工具和其它出現在插圖中或被提及的附件不包含在基本的供貨範圍。
在本公司的附件清單中標列了完整的附件。

按照規定使用機器

本電動工具適合在金屬、石材和陶瓷料上進行粗磨，以及在瓷磚上鑽孔。

使用結合磨料進行分割時，必須在機器上安裝針對分割的特殊防護罩。

分割石材時要使用合適的吸塵裝備。

安裝了護手裝置（附件）後，本電動工具也可以安裝鋼絲刷進行刷磨以及使用彈性磨盤研磨。

本電動工具只適合進行干式加工。

技術性數據











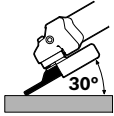

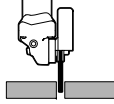

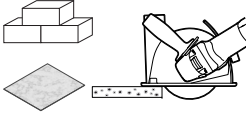
本產品的技術數據列在本使用說明書 55 – 56 頁的表格中。





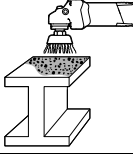

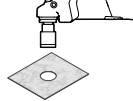



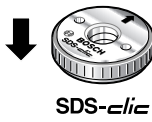

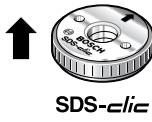
本說明書提供的參數是以 230 伏特為依據，於低電壓地區，此數據有可能不同。

請認清電動工具銘牌上的物品代碼。電動工具在銷售市場上沒有統一的商品名稱。

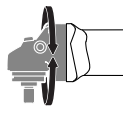
安裝和操作

以下表格顯示了在安裝和使用電動工具時的執行目的。表格中的圖形顯示了與執行目的相關的提示。因為用途不同所以會有不同的提示組合。請留心安全規章。

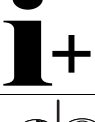
執行目的	圖片	請注意	頁數
準備研磨			57 – 58
準備分割			59 – 60
準備分割石材和瓷磚（建議）			61 – 62
準備使用吸塵罩研磨			63 – 64
準備磨除顏料			65
準備磨除鏽跡			66
準備在瓷磚上鑽孔			67

22 中文			
執行目的	圖片	請注意	頁數
安裝快速固定螺母	 SDS-clix	8 	67 - 68
拆卸快速固定螺母	 SDS-clix	9 	68
開動 / 關閉		10 	68
調整轉速		11	69
旋轉機頭		12 	70
使用角磨機有效地工作		13 	71
打上灰色記號的部位：手柄 (絕緣的握持位置)		14	71
選擇許可的磨具		15	72
選擇附件	-		73 - 75

維修和清潔

► 電動工具和通風間隙都必須保持清潔，這樣才能夠提高工作品質和安全性。

在某些極端的操作環境下，如果可能的話一定要使用吸塵裝備。吹除通氣孔中的污垢並且要使用剩于電流 - (FI) - 保護開關。加工金屬時可能在電動工具的內部堆積會導電的廢塵。這樣可能會影響電動工具的安全絕緣性能。

小心地保存和使用附件。

如果必須更換連接線，務必把這項工作交給博世或者經授權的博世電動工具顧客服務執行，以避免危害機器的安全性能。

顧客服務處和顧客諮詢中心

本公司顧客服務處負責回答有關本公司產品的修理，維護和備件的問題。以下的網頁中有爆炸圖和備件的資料：

www.bosch-pt.com

博世顧客諮詢團隊非常樂意為您解答有關本公司產品及附件的問題。

詢問和訂購備件時，務必提供機器銘牌上標示的 10 位數物品代碼。

台灣

台灣羅伯特博世股份有限公司
建國北路一段 90 號 6 樓
台北市 10491
電話：(02) 2515 5388
傳真：(02) 2516 1176
www.bosch-pt.com.tw

製造商地址：

Robert Bosch Power Tools GmbH
羅伯特·博世電動工具有限公司
70538 Stuttgart / GERMANY
70538 斯圖加特 / 德國

處理廢棄物

必須以符合環保的方式，回收再利用損壞的機器、附件和廢棄的包裝材料。

不可以把電動工具丟入家庭垃圾中。

保留修改權。

한국어

전동공구용 일반 안전수칙

경고 모든 안전수칙과 지시 사항을 상세히 읽고 지켜야 합니다. 다음의 안전수칙과 지시 사항을 준수하지 않으면 화재 위험이 있으며 감전 혹은 중상을 입을 수 있습니다.

앞으로의 참고를 위해 이 안전수칙과 사용 설명서를 잘 보관하십시오.

다음에서 사용되는 “전동공구” 라는 개념은 전원에 연결하여 사용하는 전동 기기 (전선이 있는) 나 배터리를 사용하는 전동 기기 (전선이 없는) 를 의미합니다.

작업장 안전

- ▶ 작업장을 항상 깨끗이 하고 조명을 밝게 하십시오. 작업장 환경이 어수선하거나 어두우면 사고를 초래할 수 있습니다.
- ▶ 가연성 유체, 가스 또는 분진이 있어 폭발 위험이 있는 환경에서 전동공구를 사용하지 마십시오. 전동공구는 분진이나 증기에 점화하는 스파크를 일으킬 수 있습니다.
- ▶ 전동공구를 사용할 때 구경꾼이나 어린이 혹은 다른 사람이 작업장에 접근하지 못하게 하십시오. 다른 사람이 주의를 산만하게 하면 기기에 대한 통제를 잃기 쉽습니다.

전기에 관한 안전

- ▶ 전동공구의 전원 플러그가 전원 콘센트에 잘 맞아야 합니다. 플러그를 조금이라도 변경시켜서는 안됩니다. 접지된 전동공구를 사용할 때 어댑터 플러그를 사용하지 마십시오. 변형되지 않은 플러그와 잘 맞는 콘센트를 사용하면 감전의 위험을 감소할 수 있습니다.
- ▶ 파이프 관, 라디에이터, 레인지, 냉장고와 같은 접지 표면에 몸이 닿지 않도록 하십시오. 몸에 닿을 경우 감전될 위험이 높습니다.
- ▶ 전동공구를 비에 맞지 않게 하고 습기 있는 곳에 두지 마십시오. 전동공구에 물이 들어가면 감전될 위험이 높습니다.
- ▶ 전원 코드를 잡고 전동공구를 운반하거나 걸어 놓아서는 안되며, 콘센트에서 전원 플러그를 뽑을 때 전원 코드를 잡아 당겨서는 절대로 안됩니다. 전원 코드가 열과 오일에 접촉하는 것을 피하고, 날카로운 모서리나 기기의 가동 부위에 닿지 않도록 주의하십시오. 손상되거나 영긴 전원 코드는 감전을 유발할 수 있습니다.
- ▶ 실외에서 전동공구로 작업할 때는 실외용으로 적당한 연장 전원 코드만을 사용하십시오. 실외용 연장 전원 코드를 사용하면 감전의 위험을 줄일 수 있습니다.
- ▶ 전동공구를 습기 찬 곳에서 사용해야 할 경우에는 누전 차단기를 사용하십시오. 누전 차단기를 사용하면 감전 위험을 줄일 수 있습니다.

사용자 안전

- ▶ 신중하게 작업하십시오. 작업을 할 때 주의를 하며, 전동공구를 사용할 때 경솔하게 행동하지 마십시오. 피로한 상태이거나 약물 복용 및 음주한 후에는 전동공구를 사용하지 마십시오. 전동공구를 사용할 때 잠시라도 주위가 산만해지면 중상을 입을 수 있습니다.
- ▶ 작업자 안전을 위한 장치를 사용하십시오. 항상 보안경을 착용하십시오. 전동공구의 종류와 사용에 따라 먼지 보호 마스크, 미끄러지지 않는 안전한 신발, 안전모 또는 귀마개 등의 안전한 복장을 하면 상해의 위험을 줄일 수 있습니다.
- ▶ 실수로 기기가 작동되지 않도록 주의하십시오. 전동공구를 전원에 연결하거나 배터리를 끼우기 전에, 혹은 기기를 들거나 운반하기 전에, 전원 스위치가 꺼져 있는지 다시 확인하십시오. 전동공구를 운반할 때 전원 스위치에 손가락을 대거나 전원 스위치가 켜진 상태에서 전원을 연결하면 사고 위험이 높습니다.
- ▶ 전동공구를 사용하기 전에 조절하는 톨이나 나사 키 등을 빼 놓으십시오. 회전하는 부위에 있는 톨이나 나사 키로 인해 상처를 입을 수 있습니다.
- ▶ 자신을 과신하지 마십시오. 불안정한 자세를 피하고 항상 평형을 이룬 상태로 작업하십시오. 안정된 자세와 평형한 상태로 작업해야만이 의외의 상황에서도 전동공구를 안전하게 사용할 수 있습니다.
- ▶ 알맞은 작업복을 입으십시오. 헐렁한 복장을 하거나 장신구를 착용하지 마십시오. 머리카락 또는 장갑이 가

24 | 한국어

동하는 기기 부위에 가까이 닿지 않도록 주의하십시오. 험령한 복장, 장신구 혹은 긴 머리는 가동 부위에 말려 사고를 초래할 수 있습니다.

- ▶ 분진 추출장치나 수거장치의 조립이 가능한 경우, 이 장치가 연결되어 있는지, 제대로 작동이 되는지 확인하십시오. 이러한 분진 추출장치를 사용하면 분진으로 인한 사고 위험을 줄일 수 있습니다.

전동공구의 올바른 사용과 취급

- ▶ 기기를 과부하 상태에서 사용하지 마십시오. 작업할 때 이에 적당한 전동공구를 사용하십시오. 알맞은 전동공구를 사용하면 지정된 성능 한도 내에서 더 효율적으로 안전하게 작업할 수 있습니다.
- ▶ 전원 스위치가 고장 난 전동공구를 사용하지 마십시오. 전원 스위치가 작동되지 않는 전동공구는 위험하므로, 반드시 수리를 해야 합니다.
- ▶ 기기에 세팅을 하거나 액세서리 부품을 교환하거나 혹은 기기를 보관할 때, 항상 전원 콘센트에서 플러그를 미리 빼어 놓으십시오. 이러한 조치는 실수로 전동공구가 작동하게 되는 것을 예방합니다.
- ▶ 사용하지 않는 전동공구는 어린이 손이 닿지 않는 곳에 보관하고, 전동공구 사용에 익숙지 않거나 이 사용 설명서를 읽지 않은 사람은 기기를 사용해서는 안됩니다. 경험이 없는 사람이 전동공구를 사용하면 위험합니다.
- ▶ 전동공구를 조심스럽게 관리하십시오. 가동 부위가 하자 없이 정상적인 기능을 하는지, 걸리는 부위가 있는지, 혹은 전동공구의 기능에 중요한 부품이 손상되지 않았는지 확인하십시오. 손상된 기기의 부품은 전동공구를 다시 사용하기 전에 반드시 수리를 맡기십시오. 제대로 관리하지 않은 전동공구의 경우 많은 사고를 유발합니다.
- ▶ 절단 공구를 날카롭고 깨끗하게 관리하십시오. 날카로운 절단면이 있고 잘 관리된 절단공구는 걸리는 경우가 드물고 조절하기도 쉽습니다.
- ▶ 전동공구, 액세서리, 장착하는 공구 등을 사용할 때, 이 지시 사항과 특별히 기종 별로 나와있는 사용 방법을 준수하십시오. 이때 작업 조건과 실시하려는 작업 내용을 고려하십시오. 원래 사용 분야가 아닌 다른 작업에 전동공구를 사용할 경우 위험한 상황을 초래할 수 있습니다.

서비스

- ▶ 전동공구 수리는 반드시 전문 인력에게 맡기고, 수리 정비 시 보쉬 순정 부품만을 사용하십시오. 그렇게 함으로써 기기의 안전성을 오래 유지할 수 있습니다.

앵글 그라인더용 안전 수칙

연마작업, 샌딩작업, 와이어 브러싱작업 및 절단작업 시 일반 안전 경고 사항

- ▶ 이 전동공구는 연마기, 샌딩 그라인더, 와이어 브러시 그리고 절단기로 사용할 수 있습니다. 전동공구와 함께 공급되는 모든 안전 경고 사항, 지시 사항, 도면과 사양서를 읽으십시오. 다음의 지시 사항을 준수하지 않으면 감전 그리고 / 혹은 심각한 상해를 입을 수 있습니다.
- ▶ 이 전동공구는 폴리싱작업을 하는 데 적당하지 않습니다. 전동공구의 사용 분야가 아닌 경우 사용하면 위험하며 상해를 입을 수 있습니다.
- ▶ 본 전동공구를 위해 제조사가 특별히 생산하고 추천하는 액세서리만을 사용해야 합니다. 액세서리가 전동공구에 고정될 수 있다고 해서 안전한 사용을 보장하는 것은 아닙니다.
- ▶ 허용되는 RPM 이 적어도 전동공구에 나와있는 최고 무부하 속도보다 높은 연마석을 사용해야 합니다. 허용치 이상으로 빨리 회전하는 액세서리는 깨지거나 날아갈 수 있습니다.
- ▶ 연마석의 외경과 두께는 전동공구의 크기에 맞는 것이어야 합니다. 크기가 맞지 않는 연마석은 충분히 커버할 수 없거나 통제하기가 어려워집니다.
- ▶ 나사산이 있는 액세서리는 연삭 스피indle에 정확히 맞아야 합니다. 플랜지를 사용하여 조립하는 액세서리의 경우 액세서리의 구멍 직경이 플랜지의 직경에 맞는 것이어야 합니다. 전동공구에 정확히 고정되지 않는 액세서리는 불규칙적으로 회전하고 심하게 진동하여 제어 불가능할 수 있습니다.
- ▶ 손상된 연마석을 사용하지 마십시오. 기기를 사용하기 전에 항상 연마석에 금이 가거나 파손되거나 마모 상태가 심하지 않은지, 혹은 와이어 브러시 디스크의 경우 와이어가 느슨하거나 부러지지 않았는지 확인하십시오. 전동공구나 연마석이 떨어졌을 때 손상되지 않았는지 확인하고 손상된 경우 새로운 연마석을 사용하십시오. 연마공구를 점검하고 삽입한 경우 주위에 있는 사람이나 작업자가 회전하는 연마석 쪽에서 멀리 떨어져 있도록 하고, 전동공구를 1분간 최고 속도로 작동하십시오. 손상된 연마석은 대부분 이 시험 단계에서 부러집니다.
- ▶ 작업자는 보호장비를 착용해야 합니다. 작업에 따라 안면 마스크나 보안경을 사용하십시오. 필요한 경우 분진 마스크, 귀마개, 보호장갑을 사용하고 연마로 인한 미세한 소재 분자에 접하게 되는 것을 방지하는 특수 작업용 애프린을 착용하십시오. 다양한 작업을 할 때 생겨 공중에 떠다니는 이물질로부터 눈을 보호해야 합니다. 분진 마스크나 호흡 마스크로 기기 사용 시 발생하는 분진을 여과해야 합니다. 작업자가 장기간 강한 소음 환경에서 작업하면 청력을 상실할 수도 있습니다.

- ▶ **다른 사람이 작업장에서 안전 거리를 유지하도록 해야 합니다. 작업장에 들어오는 사람은 누구나 반드시 보호장비를 착용해야 합니다.** 작업물의 파편이나 깨진 연마석이 날아가 작업대 이외의 곳에서도 상처를 입을 수 있습니다.
- ▶ **작업할 때 절단공구로 보이지 않는 전선이나 기기 자체의 코드에 닿을 위험이 있으면 전동공구의 절연된 손잡이 면만을 잡으십시오.** 전류가 흐르는 전선에 접하게 되면 기기의 금속 부위에 전기가 통해 감전될 위험이 있습니다.
- ▶ **전원 코드를 회전하는 연마석에서 멀리 하십시오.** 전동공구에 대한 통제를 잃게 되면 전원 코드가 잘려 나가거나 밀려들 수 있고, 또한 손이나 팔이 회전하는 연마석 쪽으로 빨려 들어갈 수 있습니다.
- ▶ **전동공구를 내려놓기 전에 연마석이 완전히 멈추었는지 확인하십시오.** 회전하는 연마석이 작업대 표면에 닿게 되면 전동공구에 대한 통제가 불가능할 수 있습니다.
- ▶ **항상 스위치를 끈 상태로 전동공구를 운반하십시오.** 작업자의 옷이 실수로 회전하는 연마공구에 밀려 들어 연마석이 신체 부위를 찌를 수 있습니다.
- ▶ **전동공구의 통풍구를 정기적으로 깨끗이 닦으십시오.** 모터 팬이 하우징 안으로 분진을 끌어들이며, 금속 분진이 많이 쌓이면 전기적인 위험을 야기할 수 있습니다.
- ▶ **전동공구를 가연성 물질 가까이에서 사용하지 마십시오.** 스파크가 이 물질을 점화할 수 있습니다.
- ▶ **액체 냉각제가 필요한 연마공구를 사용하지 마십시오.** 물이나 기타 액체 냉각제를 사용하면 감전될 수 있습니다.

반동과 이에 따른 안전 경고 사항

- ▶ 반동은 회전하는 전동공구의 연마석, 고무판, 와이어 브러시 디스크 등의 연마공구가 걸리거나 차단된 경우 갑자기 나타나는 작용입니다. 걸림이나 차단 상태가 되면 회전하는 연마공구가 갑자기 정지하게 됩니다. 그로 인해 통제가 안 되는 전동공구가 걸린 부위에서 연마공구 회전방향 반대쪽으로 반동이 생깁니다. 예를 들어 연마석이 작업물에 박히거나 걸리면 연마석 모서리가 작업물 안으로 들어가 걸릴 수 있습니다. 그로 인해 연마석이 부러지거나 반동을 유발할 수 있습니다. 그러면 연마석이 걸린 부위의 연마석 회전 방향에 따라 작업자 쪽으로 혹은 그 반대 쪽으로 움직입니다. 이때 연마석이 부러질 수도 있습니다. 반동은 전동공구를 잘못 사용하여 생기는 결과입니다. 이는 다음에 기술한 적당한 예방 조치를 통해 방지할 수 있습니다.
- ▶ **전동공구를 꽉 잡고, 몸과 팔은 반동력을 저지할 수 있는 자세를 취하십시오.** 보조 손잡이가 있으면, 고속 작동 시 반동력이나 반작용 모멘트를 최대한 제어하기 위해 항상 보조 손잡이를 사용하십시오. 작업자는 적

당한 예방 조치를 통해 반동력과 반작용력을 억제할 수 있습니다.

- ▶ **절대로 회전하는 연마석에 손을 가까이 대지 마십시오.** 연마석의 반동으로 인해 손을 다칠 수 있습니다.
- ▶ **반동이 생길 때 전동공구가 움직일 수 있는 곳에 있지 마십시오.** 반동으로 인해 전동공구가 걸린 부위에 있는 연마석 방향 반대쪽으로 움직입니다.
- ▶ **특히 모서리나 날카로운 가장자리 등에 작업할 때 주의하십시오.** 연마석이 작업물에서 되튀어 나가거나 걸리지 않도록 하십시오. 가장자리와 날카로운 모서리에 작업할 경우 또는 연마석이 튕겨 나가는 경우, 회전하는 연마석이 걸리는 경향이 있습니다. 이로 인해 기기의 통제가 어려워지거나 반동이 생깁니다.
- ▶ **우드카빙이나 이가 있는 틈날이 부착된 연마공구를 사용하지 마십시오.** 이러한 연마공구는 자주 반동을 유발시키고 전동공구에 대한 통제를 잃게 합니다.

연마작업 및 절단작업 시 특별 안전 경고 사항

- ▶ **반드시 귀하의 전동공구용으로 허용된 연마석과 이에 해당하는 안전반만을 사용하십시오.** 전동공구용이 아닌 연마석은 충분히 커버하기 어려울 수 있으며 안전하지 않습니다.
- ▶ **오프셋 연마석은 그 연마면이 안전반 밖으로 나오지 않도록 조립해야 합니다.** 안전반 밖으로 잘못 조립된 연마석은 충분히 커버될 수 없습니다.
- ▶ **안전반을 전동공구에 확실히 고정하고, 최대한 안전하게 맞추어야 합니다.** 즉 가능한 한 연마석의 최소 부분이 작업자쪽으로 향해 있어야 합니다. 안전반은 작업자가 파편에 다치거나 혹은 실수로 연마석이나 스파크에 접하게 되어 옷에 불이 붙는 것을 방지해 줍니다.
- ▶ **연마석은 추천하는 사용 분야에만 사용해야 합니다.** 예를 들어 절단석의 옆면으로 연마해서는 절대로 안됩니다. 절단석은 그 모서리로 소재를 깎아 내는데 사용해야 합니다. 이러한 절단석에 측면에서 힘을 가하게 되면 깨질 수 있습니다.
- ▶ **항상 사용하려는 연마석에 맞는 적당한 크기와 모양의 손상되지 않은 고정 플랜지를 사용해야 합니다.** 적당한 플랜지를 사용하면 연마석을 받쳐 주어 연마석이 파손될 위험이 줄어듭니다. 절단석용 플랜지는 연마석용 플랜지와 상이할 수 있습니다.
- ▶ **크기가 큰 전동공구에 사용하여 마모된 연마석을 사용하면 안됩니다.** 대형 전동공구용 연마석은 소형 전동공구의 고속 작업에 맞게 설계되어 있지 않으므로 파손될 위험이 있습니다.

절단작업 시 기타 특별 안전 경고 사항

- ▶ **절단석을 걸리게 하거나 과도한 힘으로 누르지 마십시오.** 절단작업 시 지나치게 깊게 절단하지 마십시오. 절단석의 과부하로 인해 부하가 증가되고 걸리거나 박히기 쉬워져, 그 결과 반동이 생기거나 절단석이 파손될 위험이 높아집니다.

26 | 한국어

- ▶ **회전하는 절단석의 앞이나 뒤쪽에 있지 마십시오.** 절단석을 작업물에서 작업자 신체 반대 방향으로 움직일 때, 반동이 생기는 경우 전동공구가 회전하는 디스크와 함께 작업자 쪽으로 직접 튕길 수 있습니다.
- ▶ **절단석이 걸려 움직이지 않거나 작업을 중단하고자 할 경우, 전동공구의 스위치를 끄고 디스크가 완전히 정지될 때까지 가만히 들고 계십시오.** 절대로 회전하고 있는 절단석을 작업물에서 잡아 당기려고 하지 마십시오. 반동이 생길 위험이 있기 때문입니다. 걸린 원인을 찾아 해결하십시오.
- ▶ **전동공구가 작업물에 있는 상태에서 다시 스위치를 켜지 마십시오.** 먼저 절단석이 최고 속도가 될 때까지 기다린 후에 절단작업을 조심스럽게 계속하십시오. 그렇게 하지 않으면 디스크가 걸리거나 작업물에서 튕겨 나오거나 반동이 생길 수 있습니다.
- ▶ **절단석이 박혀 반동이 생기는 위험을 줄이기 위해 판이나 대형 작업물은 받쳐 주십시오.** 대형 작업물은 그 자체의 중량으로 인해 쉴 수 있습니다. 작업을 절단 부위 가까이와 모서리 부위에 양쪽으로 받침대를 대어 주어야 합니다.
- ▶ **특히 벽이나 기타 보이지 않는 부위에 “포켓 절단작업”을 할 때 조심하십시오.** 가스관이나 수도관, 전선 혹은 기타 물체에 절단작업을 할 때 안으로 들어간 절단석이 반동을 유발할 수 있습니다.

샌딩작업 시 특별 안전 경고 사항

- ▶ **지나치게 큰 샌딩 페이퍼를 사용하지 말고 샌딩 페이퍼 크기에 관한 제조사의 추천 내용을 준수하십시오.** 고무판보다 큰 샌딩 페이퍼는 작업자에게 상해를 입힐 수 있고, 샌딩 페이퍼가 걸리거나 파손되며 반동이 생길 수 있습니다.

와이어 브러시 디스크로 작업할 때 특별 안전 경고 사항

- ▶ **일반적으로 사용 할 때도 와이어 브러시 디스크의 와이어가 빠질 수 있다는 것에 주의하십시오.** 와이어에 지나치게 압력을 가하여 과부하하지 마십시오. 빠져 날아가는 와이어가 얇은 옷이나 피부에 쉽게 침투할 수 있습니다.
- ▶ **안전반 사용을 추천할 경우, 안전반과 와이어 브러시가 서로 닿지 않도록 하십시오.** 와이어 칩이나 컵 브러시는 누르는 압력과 원심력으로 인해 그 직경이 확장될 수 있습니다.

기타 안전수칙 및 사용방법

- ▶ **배전 전압에 주의하십시오!** 공급되는 전원의 전압은 전동공구의 명판에 표기된 전압과 동일해야 합니다.
- ▶ **보이지 않는 배관 설비를 확인하려면 적당한 탐지기를 사용하거나 담당 에너지 공급회사에 문의하십시오.** 전선에 접하게 되면 화재나 전기 충격을 야기할 수 있습니다. 가스관을 손상시키면 폭발 위험이 있습니다. 수

도관을 파손하게 되면 재산 피해를 유발하거나 전기 충격을 야기할 수 있습니다.

- ▶ **전기가 나가거나 전원 플러그를 빼어 전원 공급이 중단된 경우 전원 스위치를 풀고 오프 위치에 놓으십시오.** 이렇게 하면 실수로 기기가 다시 작동하는 것을 방지할 수 있습니다.
- ▶ **납 성분을 함유한 페인트나 몇몇 목재 종류, 광물 및 금속 등 소재의 분진은 건강에 유해할 수 있으며 알레르기 반응이나 호흡기 질환 그리고 / 혹은 암을 유발할 수 있습니다.** 석면을 함유한 소재는 위험하므로 전문 인력들만이 작업해야 합니다.
 - 가능한하면 작업물 소재에 적당한 분진 추출장치를 사용하십시오.
 - 작업장의 통풍이 잘 되도록 하십시오.
 - 필터등급 P2가 장착된 호흡 마스크를 사용하십시오.
- ▶ **작업용 재료에 관해 국가가 지정한 규정을 고려 하십시오.**
- ▶ **작업장에 분진이 쌓이지 않도록 하십시오.** 분진이 쉽게 발화할 수 있습니다.
- ▶ **작업물을 잘 고정하십시오.** 고정장치나 기계 바이스에 끼워서 작업하면 손으로 잡는 것보다 더 안전합니다.
- ▶ **기기가 작동 중에 연마석이 깨지거나 안전반이나 전동공구에 있는 홀더 장치가 손상된 경우 전동공구를 즉시 고객 서비스 센터에 보내야 합니다 (주소는 “보쉬 AS 및 고객 상담” 참조).**
- ▶ **스파크가 작업자쪽으로 튀지 않도록 안전반을 맞추십시오.**
- ▶ **안전반은 기어 헤드의 해제 레버를 작동한 경우에만 들릴 수 있습니다.** 그렇지 않으면 전동공구를 절대로 계속 사용해서는 안되며 서비스 센터에 보내야 합니다.
- ▶ **완전히 식을 때까지 연마석이나 절단석을 만지지 마십시오.** 작업 시 매우 뜨거워지기 때문입니다.
- ▶ **스핀들 잠금 버튼은 연삭 스펀들이 완전히 정지된 상태에서만 작동하십시오.** 그렇게 하지 않으면 전동공구가 손상될 수 있습니다.
- ▶ **연마석을 조립하고 나서 전원 스위치를 켜기 전에 연마석이 제대로 조립되어 있는지 장애없이 잘 돌아가는지 확인하십시오.** 연마석이 안전반이나 다른 부위에 닿지 않도록 해야 합니다.
- ▶ **전동공구를 이동 발전기에 연결하여 작동할 경우 스위치를 켤 때 성능이 감소하거나 비정상적으로 작동할 수 있습니다.**
- ▶ **전동공구를 너무 세게 눌러 작업하면 과부하될 수 있습니다.** 과부하 상태가 되면 전동공구가 과열되어 손상될 수 있습니다. 부하가 많이 걸린 상태로 작업한 후에는 전동공구를 몇 분간 무부하 상태로 돌아가게 하여 식혀 주십시오.
- ▶ **전동공구를 그라인더 스탠드와 함께 사용하지 마십시오.**

- ▶ 절대로 절단석을 연마용으로 사용해서는 안됩니다.
- ▶ 순간 교환 너트는 연마석과 절단석의 경우에만 사용해야 합니다. 흠이 없고 손상되지 않은 순간 교환 너트만을 사용하십시오.
- ▶ 기어 헤드를 돌릴 때 완전히 빠지 마십시오 - 그림 12 참조, 70 면.

기호

다음에 나와있는 기호는 사용 설명서를 읽고 이해하는데 중요합니다. 그러므로 기호와 그 의미를 잘 기억하십시오. 기호를 제대로 이해하면 전동공구를 더욱 쉽고 안전하게 사용할 수 있습니다.

기호	의미
	제품 번호
	모든 안전 수칙과 지시 사항을 읽으십시오
	전동공구에 작업하기 전에 반드시 전원 콘센트에서 플러그를 빼십시오
	보호 장갑을 착용하십시오
	귀마개를 착용하십시오
	보안경을 착용하십시오
	이동 방향
	작업 단계에서 힘을 가하십시오.
	저속
	고속
I	스위치 켜기
O	스위치 끄기

기호	의미
	전원 스위치 고정하기
	전원 스위치 고정 상태 해제하기
	금지 사항
	허용 사항
	다음 단계
P_1	소비 전력
P_2	출력
n	정격 속도
n_v	속도 설정 범위
	l = 연삭 스피들 길이 d_1 = 연삭 스피들 직경
	D = 연마석 최대 직경 d_2 = 연마석 내경
	속도 설정
	일정 속도 전자 제어 장치
	급반동 멈춤 기능
	재작동 보호장치
	시동 전류 제한장치
<td>추가 정보</td>	추가 정보
	표면 연마
	샌딩 페이퍼로 연마
	EPTA 공정 01:2014 에 따른 중량 (진동 감소 보조 손잡이 포함)
	EPTA 공정 01:2014 에 따른 중량 (표준 보조 손잡이 포함)
	안전등급 표시 II (완전히 절연됨)

28 | 한국어

공급 내역

앵글 그라인더, 안전반, 보조 손잡이.
 특수 안전반, 연마석 및 기타 도면이나 설명서에 나와 있는 액세서리는 표준 공급부품에 속하지 않습니다.
 전체 액세서리는 본사 액세서리 프로그램을 참고하십시오.

규정에 따른 사용

본 전동공구는 금속 석재 세라믹 소재에 러핑작업을 하고 타일에 천공작업을 하는데 사용해야 합니다.
 접합된 연마제를 사용하여 절단하려면 특수한 절단작업용 안전반 (별매 액세서리) 을 사용해야 합니다.
 석재에 절단작업을 할 경우 적당한 분진 추출장치가 설치되어 있어야 합니다.

손 보호대 (별매 액세서리) 를 사용하면 신축성 있는 샌딩판으로 브러싱작업과 연마작업도 가능합니다.
 본 전동공구는 건식작업에만 적합합니다.

제품 사양











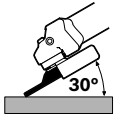

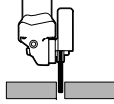
제품의 제품 사양은 본 사용 설명서의 55 - 56 면의 도표에 나와있습니다.

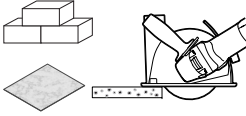





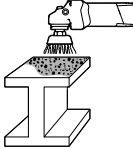



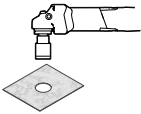







자료는 정격 전압 [U] 230 V 를 기준으로 한 것입니다.
 전압이 낮거나 각국의 특수한 모델에 따라 달라질 수 있습니다.

전동공구의 명판에 표시된 제품 번호를 확인하십시오. 각 전동공구의 명칭이 시중에서 상이하게 사용될 수 있습니다.

조립 및 작동

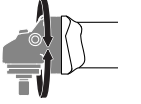
다음 도표에는 전동공구를 조립하고 작동하는데 필요한 작업 내용이 나와 있습니다. 작업 내용은 옆에 나온 그림으로 표시됩니다. 사용 분야에 따라 여러 내용을 조합하여 참고해야 합니다. 안전수칙을 준수하십시오.

작업 내용	그림	준수 내용	페이지
연마작업 준비하기			57 - 58
절단작업 준비하기			59 - 60
석재 및 타일에 절단작업 준비하기 (추천)			61 - 62
흡입 후드를 사용하는 샌딩작업 준비하기			63 - 64
페인트 제거작업 준비하기			65
녹 제거작업 준비하기			66

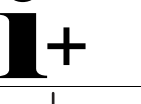
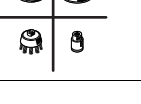
작업 내용	그림	준수 내용	페이지
타일 천공작업 준비하기		7  	67
순간 교환 너트 조립하기	 SDS- <i>clic</i>	8  	67-68
순간 교환 너트 탈착하기	 SDS- <i>clic</i>	9  	68
전원 스위치 작동하기		10   	68
속도 설정하기		11	69
기어 헤드 돌리기		12  	70
앵글 그라인더로 효율적으로 작업하기		13 	71
회색 표시 부위 : 손잡이 (절연 손잡이)		14	71
적당한 연마공구 선택하기		15	72
액세서리 선택하기	-	-	73-75

보수 정비 및 유지

▶ 안전하고 올바른 작동을 위하여 전동공구와 전동공구의 통풍구를 항상 깨끗이 하십시오.

열악한 환경에서 작업할 경우 가능한 한 추출장치를 항상 사용하도록 하십시오. 통풍구를 자주 청소하고 누전 차단기 (RCD) 를 설치하십시오. 금속 소재에 작업할 경우 전도성 분진이 전동공구 안에 쌓이게 되면 전동공구의 보호 절연장치 기능에 장애가 생길 수 있습니다.

액세서리를 조심스럽게 취급하고 보관하십시오.

연결 코드를 교환해야 할 경우 안전을 기하기 위해 보쉬 사나 보쉬 지정 전동공구 서비스 센터에 맡겨야 합니다.

보쉬 AS 및 고객 상담

보쉬는 귀하의 제품 및 수리에 관한 문의를 받고 있습니다.

30 | ภาษาไทย

AS เซ็นเตอร์ และผลิตภัณฑ์เกี่ยวกับลูกค้า AS เซ็นเตอร์ และผลิตภัณฑ์เกี่ยวกับลูกค้า AS เซ็นเตอร์ และผลิตภัณฑ์เกี่ยวกับลูกค้า

AS เซ็นเตอร์ และผลิตภัณฑ์เกี่ยวกับลูกค้า AS เซ็นเตอร์ และผลิตภัณฑ์เกี่ยวกับลูกค้า

AS เซ็นเตอร์ และผลิตภัณฑ์เกี่ยวกับลูกค้า AS เซ็นเตอร์ และผลิตภัณฑ์เกี่ยวกับลูกค้า

AS เซ็นเตอร์ และผลิตภัณฑ์เกี่ยวกับลูกค้า AS เซ็นเตอร์ และผลิตภัณฑ์เกี่ยวกับลูกค้า

AS เซ็นเตอร์ และผลิตภัณฑ์เกี่ยวกับลูกค้า AS เซ็นเตอร์ และผลิตภัณฑ์เกี่ยวกับลูกค้า

AS เซ็นเตอร์ และผลิตภัณฑ์เกี่ยวกับลูกค้า AS เซ็นเตอร์ และผลิตภัณฑ์เกี่ยวกับลูกค้า

AS เซ็นเตอร์ และผลิตภัณฑ์เกี่ยวกับลูกค้า AS เซ็นเตอร์ และผลิตภัณฑ์เกี่ยวกับลูกค้า

AS เซ็นเตอร์ และผลิตภัณฑ์เกี่ยวกับลูกค้า AS เซ็นเตอร์ และผลิตภัณฑ์เกี่ยวกับลูกค้า

처리

AS เซ็นเตอร์ และผลิตภัณฑ์เกี่ยวกับลูกค้า AS เซ็นเตอร์ และผลิตภัณฑ์เกี่ยวกับลูกค้า

AS เซ็นเตอร์ และผลิตภัณฑ์เกี่ยวกับลูกค้า AS เซ็นเตอร์ และผลิตภัณฑ์เกี่ยวกับลูกค้า

AS เซ็นเตอร์ และผลิตภัณฑ์เกี่ยวกับลูกค้า AS เซ็นเตอร์ และผลิตภัณฑ์เกี่ยวกับลูกค้า

ภาษาไทย

คำเตือนทั่วไปเพื่อความปลอดภัยในการใช้เครื่องมือไฟฟ้า

คำเตือน ต้องอ่านคำเตือนเพื่อความปลอดภัยและคำสั่งทั้งหมด การไม่ปฏิบัติตามคำเตือนและคำสั่งอาจเป็นสาเหตุให้ถูกไฟฟ้าดูด เกิดไฟไหม้ และ/หรือได้รับบาดเจ็บอย่างร้ายแรง

เก็บรักษาคำเตือนและคำสั่งทั้งหมดสำหรับเปิดอ่านในภายหลัง

คำว่า "เครื่องมือไฟฟ้า" ในคำเตือนหมายถึง เครื่องมือไฟฟ้าของท่านที่ทำงานด้วยพลังงานไฟฟ้าที่ต่อจากเต้าเสียบ (มีสายไฟฟ้า) และเครื่องมือไฟฟ้าที่ทำงานด้วยพลังงานไฟฟ้าจากแบตเตอรี่ (ไร้สาย)

ความปลอดภัยในสถานที่ทำงาน

- ▶ รักษาสถานที่ทำงานให้สะอาดและมีไฟส่องสว่างดี สถานที่ที่มีมืดหรือรกรุงรังนำมาซึ่งอุบัติเหตุ
- ▶ อย่าใช้เครื่องมือไฟฟ้าในสภาพแวดล้อมที่เสี่ยงต่อการติดระเบิดได้ เช่น ในที่มีของเหลว แก๊ส หรือฝุ่นที่ติดไฟได้ เมื่อใช้เครื่องมือไฟฟ้าจะเกิดประกายไฟซึ่งอาจจุดฝุ่นหรือไอให้ลุกเป็นไฟได้
- ▶ ขณะใช้เครื่องมือไฟฟ้าทำงาน ต้องก้มเด็กและผู้ยืนดูให้ออกห่าง การหันเหความสนใจอาจทำให้ท่านขาดการควบคุมเครื่องได้

ความปลอดภัยเกี่ยวกับไฟฟ้า

- ▶ ปลั๊กของเครื่องมือไฟฟ้าต้องมีขนาดพอดีกับเต้าเสียบ อย่าตัดแปลงหรือแก้ไขตัวปลั๊กอย่างเด็ดขาด อย่าต่อปลั๊กต่อใดๆ เข้ากับเครื่องมือไฟฟ้าที่มีสายดิน ปลั๊กที่ไม่ตัดแปลงและเต้าเสียบที่เข้ากันช่วยลดความเสี่ยงจากการถูกไฟฟ้าดูด
- ▶ หลีกเลี่ยงไม่ให้ร่างกายสัมผัสกับพื้นผิวของสิ่งของต่อสายดินไว้ เช่น ท่อ เครื่องทำความร้อน เตา และตู้เย็น จะเสี่ยงอันตรายจากการถูกไฟฟ้าดูดมากขึ้นหากกระแสไฟฟ้าวิ่งผ่านร่างกายของท่านลงดิน
- ▶ อย่าวางเครื่องมือไฟฟ้าคาบคนหรือทิ้งไว้ในที่ชื้นและหากน้ำเข้าในเครื่องมือไฟฟ้า จะเพิ่มความเสี่ยงจากการถูกไฟฟ้าดูด
- ▶ อย่าใช้สายไฟฟ้าอย่างผิดๆ อย่าถือเครื่องมือไฟฟ้าที่สาย อย่าใช้สายแฉกหรือสายที่ชำรุดหรือสายไฟฟ้าเพื่อถอดปลั๊กออกจากเต้าเสียบ ถอนสายไฟฟ้าออกห่างจากความร้อน น้ำมัน ขอบแหลมคม หรือส่วนของเครื่องที่กำลังเคลื่อนไหว สายไฟฟ้าที่ชำรุดหรือพันกันอยู่เพิ่มความเสี่ยงจากการถูกไฟฟ้าดูด
- ▶ เมื่อใช้เครื่องมือไฟฟ้าทำงานกลางแจ้ง ให้ใช้สายไฟต่อที่ได้รับการรับรองให้ใช้ต่อในที่กลางแจ้งเท่านั้น การใช้สายไฟต่อที่เหมาะสมสำหรับงานกลางแจ้งช่วยลดอันตรายจากการถูกไฟฟ้าดูด
- ▶ หากไม่สามารถหลีกเลี่ยงการใช้เครื่องมือไฟฟ้าทำงานในสถานที่เปียกชื้นได้ ให้ใช้สวิทช์ตัดวงจรเมื่อเกิดการรั่วไหลของไฟฟ้าจากสายดิน การใช้สวิทช์ตัดวงจรเมื่อเกิดการรั่วไหลของไฟฟ้าจากสายดินช่วยลดความเสี่ยงต่อการถูกไฟฟ้าดูด

ความปลอดภัยของบุคคล

- ▶ ท่านต้องอยู่ในสภาพเตรียมพร้อม ระมัดระวังในสิ่งที่กำลังทำอยู่ และมีสติขณะใช้เครื่องมือไฟฟ้าทำงาน อย่าใช้เครื่องมือไฟฟ้าขณะที่ท่านกำลังเหนื่อย หรืออยู่ภายใต้การครอบงำของฤทธิ์ของยาเสพติด แอลกอฮอล์ และยา เมื่อใช้เครื่องมือไฟฟ้าทำงาน ในชั่วขณะที่ท่านขาดความเอาใจใส่อาจทำให้บุคคลบาดเจ็บอย่างรุนแรงได้
- ▶ ใช้อุปกรณ์ปกป้องร่างกาย สวมแว่นตาป้องกันเสมอ อุปกรณ์ปกป้อง เช่น หน้ากากกันฝุ่น รองเท้ากันลื่น หมวกแข็ง หรือประภคกันเสียงดัง ที่เลือกใช้ตามความเหมาะสมกับสภาพการทำงาน สามารถลดอันตรายต่อบุคคลได้
- ▶ ป้องกันการติดเครื่องโดยไม่ตั้งใจ ต้องดูให้แน่ใจว่าสวิทช์อยู่ในตำแหน่งปิดก่อนเสียบปลั๊กไฟเข้าในเต้าเสียบ และ/หรือใส่แท่งแบตเตอรี่ ยกขึ้นหรือถือเครื่องมือ การถือเครื่องโดยใช้นิ้วหัวแม่มือหรือ

เสียบปลั๊กไฟฟ้าขณะสวิตช์เปิดอยู่ อาจนำไปสู่อุบัติเหตุที่ร้ายแรงได้

- ▶ **เอาเครื่องมือปรับแต่งหรือประแจปากตายออกจากเครื่องมือไฟฟ้าก่อนเปิดสวิตช์** เครื่องมือหรือประแจปากตายที่วางอยู่กับส่วนของเครื่องที่กำลังหมุนจะทำให้บุคคลบาดเจ็บได้
- ▶ **หลีกเลี่ยงการตั้งท่าที่ผิดปกติ ตั้งท้ายขึ้นที่มั่นคงและวางน้ำหนักให้สมดุลตลอดเวลา** ในลักษณะนี้ท่านสามารถควบคุมเครื่องมือไฟฟ้าในสถานการณ์ที่ไม่คาดคิดได้ดีกว่า
- ▶ **ใส่เสื้อผ้าที่เหมาะสม** อย่าใส่เสื้อผ้าหลวมหรือสวมเครื่องประดับ เอาผม เลือ่ผ้า และถุงมือออกห่างส่วนของเครื่องที่กำลังหมุน เลือ่ผ้าหลวม เครื่องประดับ และผมยาวอาจเข้าไปติดในส่วนของเครื่องที่กำลังหมุนได้
- ▶ **หากต้องต่อเครื่องมือไฟฟ้าเข้ากับเครื่องดูดฝุ่นหรือเครื่องเก็บผง** ดูให้แน่ใจว่าการเชื่อมต่อและการใช้งานเป็นไปอย่างถูกต้อง การใช้อุปกรณ์ดูดฝุ่นช่วยลดอันตรายที่เกิดจากฝุ่นได้

การใช้และการดูแลรักษาเครื่องมือไฟฟ้า

- ▶ **อย่าใช้เครื่องมือไฟฟ้าอย่างหักโหม ใช้เครื่องมือไฟฟ้าที่ถูกต้องตรงตามลักษณะงาน** เครื่องมือไฟฟ้าที่ถูกต้องจะทำงานได้ดีกว่าและปลอดภัยกว่าในระดับสมรรถภาพที่ออกแบบไว้
- ▶ **อย่าใช้เครื่องมือไฟฟ้าที่สวิตช์เปิดปิดเสีย** เครื่องมือไฟฟ้าที่ไม่สามารถควบคุมการเปิดปิดด้วยสวิตช์ได้ เป็นเครื่องมือไฟฟ้าที่ไม่ปลอดภัยและต้องส่งซ่อมแซม
- ▶ **ก่อนปรับแต่งเครื่อง เปลี่ยนอุปกรณ์ประกอบ หรือเก็บเครื่องเข้าที่** ต้องถอดปลั๊กไฟออกจากเต้าเสียบและ/หรือถอดแท่งแบตเตอรี่ออกจากเครื่องมือไฟฟ้า มาตรการป้องกันเพื่อความปลอดภัยนี้ช่วยลดความเสี่ยงจากการติดเครื่องโดยไม่ได้ตั้งใจ
- ▶ **เมื่อเลิกใช้งานเครื่องมือไฟฟ้า ให้เก็บเครื่องไว้ในที่ที่เด็กหยิบไม่ถึง และไมอนุญาตให้บุคคลที่ไม่คุ้นเคยกับเครื่องหรือบุคคลที่ไม่ได้อ่านคำแนะนำนี้ใช้เครื่องมือไฟฟ้า** เป็นของอันตรายหากตกอยู่ในมือของผู้ใช้ที่ไม่ได้รับการฝึกฝน
- ▶ **เอาใจใส่ดูแลรักษาเครื่อง** ตรวจสอบหาส่วนที่เคลื่อนไหวได้ของเครื่องว่าวางอยู่ตรงแนวหรือติดขัดหรือไม่ ตรวจสอบการแตกหักของชิ้นส่วนและสภาพอื่นใดที่อาจมีผลต่อการทำงานของเครื่องมือไฟฟ้า หากชำรุดต้องส่งเครื่องมือไฟฟ้าซ่อมแซมก่อนใช้งาน อุบัติเหตุหลายอย่างเกิดขึ้นเนื่องจากดูแลรักษาเครื่องไม่ดีพอ

- ▶ **รักษาเครื่องมือตัดให้คมและสะอาด** หากบำรุงรักษาเครื่องมือที่มีขอบตัดแหลมคมอย่างถูกต้อง จะสามารถตัดได้ลื่นไม่ติดขัดและควบคุมได้ง่ายกว่า
- ▶ **ใช้เครื่องมือไฟฟ้า อุปกรณ์ประกอบ เครื่องมือ และอุปกรณ์อื่นๆ ให้ตรงตามคำแนะนำนี้ และในลักษณะตามที่เครื่องมือไฟฟ้าประเภทนั้นๆ กำหนดไว้** โดยต้องคำนึงถึงเงื่อนไขการทำงานและงานที่จะทำด้วย การใช้เครื่องมือไฟฟ้าทำงานที่ต่างไปจากวัตถุประสงค์การใช้งานของเครื่อง อาจนำไปสู่สถานการณ์ที่เป็นอันตรายได้

การบริการ

- ▶ **ส่งเครื่องมือไฟฟ้าให้ช่างผู้เชี่ยวชาญตรวจสอบและใช้อะไหล่เปลี่ยนของแท้เท่านั้น** ในลักษณะนี้ท่านจะแน่ใจได้ว่าเครื่องมือไฟฟ้าอยู่ในสภาพที่ปลอดภัย

คำแนะนำเพื่อความปลอดภัยสำหรับเครื่องขัดมุม

คำแนะนำเพื่อความปลอดภัยที่ใช้ร่วมกันสำหรับการขัด การขัดด้วยกระดาษทราย การแปร่งด้วยลวด และการตัดออก

- ▶ **เครื่องมือไฟฟ้านี้ผลิตขึ้นเพื่อทำหน้าที่เป็นเครื่องขัด เครื่องขัดด้วยกระดาษทราย เครื่องแปร่งด้วยลวด หรือเครื่องตัดออก** กรุณาอ่านคำแนะนำเพื่อความปลอดภัย คำสั่ง ภาพประกอบ และรายละเอียดทั้งหมดที่จัดส่งมาพร้อมกับเครื่องมือไฟฟ้านี้ การละเลยไม่ปฏิบัติตามคำสั่งทั้งหมดที่ระบุด้านล่างนี้อาจ ทำให้ถูกไฟฟ้ากระตุก เกิดไฟไหม้ และ/หรือบาดเจ็บสาหัสได้
- ▶ **เครื่องมือไฟฟ้านี้ไม่เหมาะสำหรับใช้ขัดเงา** หากใช้เครื่องทำงานที่ไม่ได้ถูกออกแบบมาสำหรับงานนั้นๆ อาจทำให้เกิดอันตรายและบาดเจ็บได้
- ▶ **อย่าใช้อุปกรณ์ประกอบที่ผู้ผลิตมิได้แนะนำให้ใช้ และมีได้ออกแบบไว้ให้ใช้เฉพาะกับเครื่องมือไฟฟ้านี้** ด้วยเหตุนี้เพราะท่านสามารถประกอบอุปกรณ์เข้ากับเครื่องมือไฟฟ้าของท่านได้ ก็มีได้เป็นการรับรองว่าท่านจะปฏิบัติตามได้อย่างปลอดภัย
- ▶ **ความเร็วรอบกำหนดของอุปกรณ์ประกอบอย่างน้อยที่สุดต้องสูงเท่ากับความเร็วรอบกำหนดสูงสุดที่ระบุไว้บนเครื่องมือไฟฟ้า** อุปกรณ์ประกอบที่หมุนเร็วกว่าความเร็วรอบกำหนดของตัวเองอาจกระเด็นออกเป็นชิ้นๆ
- ▶ **เส้นผ่าศูนย์กลางรอบนอกและความหนาของอุปกรณ์ประกอบของท่านต้องอยู่ในที่กีดความสามารถของเครื่องมือไฟฟ้าของท่าน** อุปกรณ์ประกอบผิดขนาดจะได้รับการปกป้องและควบคุมได้ไม่เพียงพอ

32 | ภาษาไทย

- ▶ อุปกรณ์ประกอบที่ติดตั้งโดยการหมุนเกลียว ต้องมีขนาดเกลียวที่เข้ากันพอดีกับเกลียวของแกนเครื่องขัด สำหรับอุปกรณ์ประกอบที่ต้องใช้จานเกลียวช่วย รูปลอกแกนของอุปกรณ์ประกอบต้องมีขนาดพอดีกับเส้นผ่าศูนย์กลางของจานเกลียว อุปกรณ์ประกอบที่ไม่สามารถยึดติดกับเครื่องมือไฟฟ้าได้อย่างพอดีพอดี จะหมุนเสียหลัก ลั่นตัวมาก และอาจทำให้สูญเสียการควบคุม
- ▶ อย่าใช้อุปกรณ์ประกอบที่ชำรุด ตรวจสอบอุปกรณ์ประกอบก่อนใช้งานทุกครั้ง เช่น จานขัดให้ดูรอยบิ่นและรอยแตกร้าว แผ่นหมุนให้ดูรอยแตกร้าว รอยฉีกหรือรอยสึกหรอที่มากเกินไป แปรงลวดให้ดูการโยกคลอนหรือการแตกหักของเส้นลวด หากเครื่องมือไฟฟ้าหรืออุปกรณ์ประกอบตกรัง ให้ตรวจสอบความเสียหายหรือประกอบอุปกรณ์ที่ไม่ชำรุดเข้า เมื่อตรวจสอบและใส่อุปกรณ์ประกอบเสร็จแล้ว ตัวท่านเองและตัวบุคคลที่อยู่ใกล้เคียงต้องออกจากแนวระดับอุปกรณ์ประกอบที่หมุน และเปิดเครื่องมือไฟฟ้าเดินตัวเปล่าที่ความเร็วรอบสูงสุดนาน 1 นาที ตามปกติอุปกรณ์ประกอบที่ชำรุดจะแตกออกเป็นชิ้นๆ ในช่วงเวลาทดสอบวิ่งนี้
- ▶ สวมอุปกรณ์ป้องกันเฉพาะตัว สุดแล้วแต่กรณีให้ใช้กระบังป้องกันหน้า สวมแว่นตากันลมและฝุ่นหรือแว่นตาป้องกันอันตราย สุดแล้วแต่ความเหมาะสมให้สวมหน้ากากกันฝุ่น สวมประภทหูป้องกันเสียงดัง สวมถุงมือ และสวมผ้ากันเปื้อนพิเศษที่สามารถกันผงขัดหรือเศษชิ้นงานออกจากตัวท่านได้ แวนป้องกันตาต้องสามารถหยุดเศษผงที่ปลิวว่อนที่เกิดจากการปฏิบัติงานแบบต่างๆ ได้ หน้ากากกันฝุ่นหรือหน้ากากป้องกันการติดเชื้อต้องสามารถกรองอนุภาคที่เกิดจากการปฏิบัติงานของท่านได้ การไต่ยีนเสียงดังมากเป็นเวลานานอาจทำให้ท่านสูญเสียการได้ยิน
- ▶ กันบุคคลที่อยู่ใกล้เคียงให้อยู่ในระยะปลอดภัยห่างจากบริเวณทำงาน บุคคลใดที่เข้ามายังบริเวณทำงานต้องสวมอุปกรณ์ป้องกันเฉพาะตัว เศษวัสดุชิ้นงานหรืออุปกรณ์ประกอบที่แตกหักอาจปลิวออกนอกจุดปฏิบัติงานและทำให้บาดเจ็บได้
- ▶ เมื่อทำงานในบริเวณที่อุปกรณ์ตัดอาจสัมผัสกับสายไฟฟ้าที่ซ่อนอยู่หรือสายไฟฟ้าของเครื่อง ต้องจับเครื่องมือไฟฟ้าตรงด้ามจับที่หุ้มฉนวนเท่านั้น หากอุปกรณ์ตัดสัมผัสกับสายที่มีกระแสไฟฟ้าไหลผ่านจะทำให้ส่วนที่เป็นโลหะของเครื่องมือไฟฟ้าเกิดมีกระแสไฟฟ้าด้วย และส่งผลให้ผู้ใช้เครื่องถูกไฟฟ้ากระตุกได้
- ▶ จับสายไฟฟ้าออกจากอุปกรณ์ประกอบที่กำลังหมุน หากท่านควบคุมเครื่องมือไฟฟ้าไม่อยู่ เครื่องอาจตัดสายไฟฟ้าหรือสายไฟฟ้าถูกดึงรั้งไว้ และมีหรือแขนของท่านอาจถูกกระชากเข้าหาอุปกรณ์ประกอบที่กำลังหมุน

- ▶ อย่าวางเครื่องมือไฟฟ้าลงบนพื้นจนกว่าอุปกรณ์ประกอบจะหยุดหมุนและนิ่งอยู่กับที่แล้ว อุปกรณ์ประกอบที่หมุนอยู่อาจเฉี่ยวถูกพื้นและกระชากเครื่องมือไฟฟ้าออกจากการควบคุมของท่าน
- ▶ อย่าเปิดเครื่องมือไฟฟ้าทำงานขณะถือเครื่องไว้ข้างตัว เสื้อผ้าของท่านอาจเกี่ยวพันกับอุปกรณ์ประกอบที่กำลังหมุนโดยไม่ตั้งใจ และจุดอุปกรณ์ประกอบเข้าหาร่างกายของท่านได้
- ▶ ทำความสะอาดช่องระบายอากาศของเครื่องมือไฟฟ้าอย่างสม่ำเสมอ พัดลมของมอเตอร์จะดูดผงฝุ่นเข้าในหม้อครอบ และผงโลหะที่พอกสะสมกันมากๆ อาจทำให้เกิดอันตรายจากไฟฟ้าได้
- ▶ อย่าใช้เครื่องมือไฟฟ้าทำงานใกล้วัตถุติดไฟได้ ประกายไฟสามารถจุดวัตถุเหล่านี้ให้ลุกเป็นไฟ
- ▶ อย่าใช้อุปกรณ์ประกอบที่ต้องใช้สารหล่อเย็นที่เป็นของเหลว การใช้น้ำหรือสารหล่อเย็นอื่นๆ ที่เป็นของเหลว อาจทำให้กระแสไฟฟ้าวิ่งผ่านเข้าตัวจนเสียชีวิตหรือถูกไฟฟ้ากระตุกได้

การตีกลับและค่าเตือนเกี่ยวเนื่อง

- ▶ การตีกลับคือแรงสะท้อนกะทันหันที่เกิดจากจานขัด แผ่นหมุน แปรง และอุปกรณ์ประกอบอื่นใดเกิดบิดหรือถูกเหนี่ยวรั้งขณะกำลังหมุน การบิดหรือการเหนี่ยวรั้งทำให้ อุปกรณ์ประกอบที่กำลังหมุนหยุดกะทันหัน ด้วยเหตุนี้ เครื่องมือไฟฟ้าที่ขาดการควบคุมจึงถูกผลักไปในทิศทางตรงกันข้ามกับการหมุนของอุปกรณ์ประกอบ ณ จุดที่เกิดการติดขัด
- ▶ ตัวอย่าง เช่น หากจานขัดถูกเหนี่ยวรั้งหรือบิดโดยชิ้นงานขอบของจานขัดที่จุ่มอยู่ในจุดบิดอาจขูดเข้าไปในพื้นผิวของชิ้นงาน ทำให้จานขัดบินออกมาหรือตีกลับ จานขัดอาจกระโดดเข้าหาหรือกระโดดออกจากผู้ใช้เครื่อง ทั้งนี้ขึ้นอยู่กับทิศทางเคลื่อนที่ของจานขัด ณ จุดบิด ในสถานการณ์เช่นนี้จานขัดอาจแตกหักได้ด้วย
- ▶ การตีกลับเป็นผลจากการใช้เครื่องมือไฟฟ้าอย่างผิดวิธี และ/หรือมีกระบวนการหรือเงื่อนไขการทำงานที่ไม่ถูกต้อง และสามารถหลีกเลี่ยงได้ด้วยการป้องกันไว้ก่อน อย่างถูกต้อง ดังคำแนะนำด้านล่างนี้
- ▶ จับเครื่องมือไฟฟ้าให้แน่น และตั้งตัวและแขนในตำแหน่งต้านรับแรงตีกลับ หากมีด้ามจับเพิ่ม ต้องใช้ด้ามจับเพิ่มร่วมด้วยเสมอ เพื่อควบคุมการตีกลับหรือกำลังสะท้อนจากแรงบิดขณะสตาร์ทเครื่องให้ได้ดีที่สุด ผู้ใช้เครื่องสามารถควบคุมกำลังสะท้อนจากแรงบิดหรือการตีกลับ หากได้ระมัดระวังอย่างถูกต้องไว้ก่อน

- ▶ **อย่ายื่นมือเข้าใกล้อุปกรณ์ประกอบที่กำลังหมุน** อุปกรณ์ประกอบอาจตีกลับมาที่มือของท่านได้
- ▶ **อย่าให้ร่างกายของท่านอยู่ในบริเวณที่เครื่องมือไฟฟ้าจะเคลื่อนเข้าหาหากมีการตีกลับ** การตีกลับจะผลักเครื่องมือไฟฟ้าไปยังทิศทางตรงกันข้ามกับการเคลื่อนที่ของจานขัด ณ จุดเหนี่ยวรั้ง
- ▶ **ใช้ความระมัดระวังเป็นพิเศษเมื่อใช้เครื่องทำงานบริเวณมุม ขอบแหลมคม ฯลฯ** หลีกเลี่ยงไม่ให้อุปกรณ์ประกอบกระแทกและเหนี่ยวรั้งกับชิ้นงาน มุม ขอบแหลมคม และการกระแทกมักจะเหนี่ยวรั้งอุปกรณ์ประกอบที่กำลังหมุน และทำให้ขาดการควบคุมหรือทำให้เกิดการตีกลับ
- ▶ **อย่าประกอบใบเลื่อยโซ่สำหรับเข่าไม้หรือเลื่อยมีฟันใบเลื่อยเหล่านี้ทำให้เกิดการตีกลับและสูญเสียการควบคุมบ่อยครั้ง**

คำเตือนเพื่อความปลอดภัยเฉพาะสำหรับการขัดและการตัดออก

- ▶ **งานที่ใช้ต้องเป็นงานประเภทเดียวกับที่แนะนำไว้ให้กับเครื่องมือไฟฟ้าของท่าน และให้ใช้กระบังเฉพาะที่ออกแบบไว้สำหรับใช้ร่วมกับงานที่เลือกใช้นั้น** งานที่ไม่ได้ออกแบบไว้สำหรับใช้กับเครื่องมือไฟฟ้าจะได้รับการปกป้องไม่เพียงพอและไม่ปลอดภัย
- ▶ **ต้องติดตั้งล้อหินเจียร์ศูนย์จมในลักษณะที่พื้นผิวเจียร์จะต้องไม่ยื่นออกมาจนกระทบของขอบกระบังป้องกันอันตราย** ล้อที่ติดตั้งอย่างไม่ถูกต้องที่ยื่นออกมาจนกระทบของขอบกระบังป้องกันอันตรายจะไม่ได้รับการป้องกันอย่างเพียงพอ
- ▶ **ต้องประกอบกระบังเข้ากับเครื่องมือไฟฟ้าให้แน่นหนา และปรับตำแหน่งให้ได้ความปลอดภัยสูงสุด เพื่อให้จานโผล่เข้าหาตัวผู้ใช้เครื่องมือที่น้อยที่สุด** กระบังช่วยป้องกันผู้ใช้เครื่องจากชิ้นส่วนจานที่แตก การสัมผัสกับจานโดยไม่ตั้งใจ และประกายไฟที่อาจจุดเสื้อผ้าให้ลุกไหม้ได้
- ▶ **ต้องใช้จานตามประโยชน์การใช้งานที่แนะนำเท่านั้น ตัวอย่าง เช่น อย่าใช้ด้านข้างของจานตัดสำหรับขัดวัสดุ** จานตัดผลิตไว้เพื่อให้ใช้ตรงขอบนอกของจานขัดวัสดุ แรงด้านข้างที่กดลงบนแผ่นจานอาจทำให้จานแตกละเอียดได้
- ▶ **ใช้น็อตรองจานที่ไม่ชำรุดที่มีขนาดและรูปทรงถูกต้องสำหรับงานที่ท่านเลือกใช้** น็อตรองจานที่ถูกต้องจะหนุนจาน และด้วยเหตุนี้จึงลดการแตกหักของจาน น็อตรองสำหรับจานตัดอาจมีลักษณะต่างจากน็อตรองสำหรับจานขัด
- ▶ **อย่าใช้จานที่สึกกร่อนมาจากเครื่องมือไฟฟ้าขนาดใหญ่กว่า** จานที่ผลิตไว้สำหรับเครื่องมือไฟฟ้าขนาดใหญ่

กว่าไม่เหมาะจะนำมาใช้กับเครื่องมือไฟฟ้าขนาดเล็กที่มีความเร็วสูงกว่า และอาจแตกระเบิดได้

คำเตือนเพิ่มเติมเพื่อความปลอดภัยเฉพาะสำหรับการตัดออก

- ▶ **หลีกเลี่ยงไม่ให้จานตัด "ติดขัด" หรือยักจนแรงเกินไป** อย่าพยายามตัดให้ได้ร่องลึกเกินไป การกดจานลงมากเกินไปจะเพิ่มภาระแก่จานและทำให้จานบิดหรือติดขัดในร่องตัดได้ง่ายขึ้น และเพิ่มความเสี่ยงการตีกลับหรือทำให้จานแตกหักได้
- ▶ **อย่าให้ร่างกายของท่านอยู่ในบริเวณด้านหน้าหรือด้านหลังของงานที่กำลังหมุน** ขณะที่งานในชิ้นงานเคลื่อนจากร่างกายของท่านออกไป การตีกลับที่อาจเกิดขึ้นได้จะดันงานที่กำลังหมุนรวมทั้งเครื่องมือไฟฟ้ากลับเข้าหาร่างกายของท่านได้โดยตรง
- ▶ **เมื่อจานติดขัดหรือเมื่องานตัดหยุดชะงักด้วยเหตุใดก็ตามให้ปิดสวิทช์เครื่องมือไฟฟ้าและถือเครื่องมือไฟฟ้าไว้อย่าได้เคลื่อนไหวยจนกว่าจะหยุดนิ่งอยู่กับที่** อย่าพยายามถอดจานตัดออกจากร่องตัดขณะที่งานยังหมุนอยู่ มิฉะนั้นอาจเกิดการตีกลับได้ ตรวจสอบและแก้ไขเพื่อขจัดสาเหตุที่ทำให้จานติดขัด
- ▶ **อย่าเปิดเครื่องมือไฟฟ้าทำงานอีกครั้งขณะที่งานยังคงค้างอยู่ในชิ้นงาน** ปลดปล่อยให้จานหมุนด้วยความเร็วรอบสูงสุดแล้วจึงตัดต่อไปอย่างระมัดระวัง จานอาจติดขัดกระโดดขึ้น หรือตีกลับ หากเปิดเครื่องมือไฟฟ้าทำงานอีกครั้งในชิ้นงาน
- ▶ **หนุนแผ่นกระดานหรือชิ้นงานใดๆ ที่มีขนาดใหญ่เกินไปเพื่อลดความเสี่ยงการบิดงอและการตีกลับของงาน** ชิ้นงานขนาดใหญ่มักจะห้อยหย่อนตามความถ่วงน้ำหนักของตัวเอง ต้องสอดแผ่นหนุนใต้ชิ้นงานทั้งสองด้าน ทั้งใกล้เส้นตัดและใกล้ขอบของชิ้นงาน
- ▶ **ใช้ความระมัดระวังเป็นพิเศษเมื่อ "ตัดรูปทรงกระเปาะ" เข้าในผ้านั่งหรือในบริเวณอื่นที่ไม่สามารถมองเห็นได้** งานที่ยื่นออกมาอาจตัดเข้าไปในท่อแก๊สหรือท่อน้ำ สายไฟฟ้า หรือวัตถุที่อาจทำให้เกิดการตีกลับได้

คำเตือนเพื่อความปลอดภัยเฉพาะสำหรับการขัดด้วยกระดาษทราย

- ▶ **เมื่อขัดด้วยกระดาษทราย อย่าใช้แผ่นกระดาษทรายที่มีขนาดใหญ่เกินไป ให้ปฏิบัติตามคำแนะนำของบริษัทผู้ผลิตเมื่อเลือกกระดาษทราย** กระดาษทรายที่มีขนาดใหญ่กว่าที่ยื่นยาวออกนอกแผ่นรองขัดอาจทำให้ท่านบาดเจ็บและกระดาษทรายอาจถูกเหนี่ยวรั้ง ฉีกขาด หรือทำให้เกิดการตีกลับได้

34 | ภาษาไทย

คำเตือนเพื่อความปลอดภัยเฉพาะสำหรับการขัดด้วยแปรงลวด

- ▶ **พึงคำนึงว่า ขณะใช้แปรงขัดตามปกติ ขนแปรงลวดจะหลุดจากแปรงไปเอง อย่ากดเส้นลวดลงหนักเกินไปโดยใช้กำลังย่ำลงบนแปรง** ขนแปรงลวดสามารถแทงทะลุผ้าบางๆ และ/หรือผิวหนังได้อย่างง่ายดาย
- ▶ **เมื่อต้องการแปรง หากมีการแนะนำให้ใช้กระบ้งร่วมด้วย ต้องดูไม่ให้จานลวดหรือแปรงลวดสัมผัสกับตัวกระบ้ง** จานลวดหรือแปรงลวดจะบานออกและมีเส้นผ่าศูนย์กลางกว้างขึ้นเนื่องจากแรงกดและแรงเหวี่ยงจากจุดศูนย์กลาง

วิธีปฏิบัติงานและคำแนะนำเพื่อความปลอดภัยเพิ่มเติม

- ▶ **ให้สังเกตแรงดันไฟฟ้า! แรงดันไฟฟ้าจากแหล่งจ่ายไฟฟ้าต้องสอดคล้องกับข้อมูลบนแผ่นป้ายติดของเครื่อง**
- ▶ **ใช้เครื่องตรวจที่เหมาะสมตรวจหาท่อ สายไฟฟ้า หรือสายโทรศัพท์ ที่อาจซ่อนอยู่ในบริเวณที่ทำงาน หรือขอความช่วยเหลือจากบริษัทสาธารณูปโภคในท้องถิ่น การสัมผัสกับสายไฟฟ้าอาจทำให้เกิดไฟไหม้หรือถูกไฟฟ้าดูด การทำให้ท่อแก๊สเสียหายอาจทำให้เกิดระเบิด การเจาะเข้าในท่อน้ำทำให้ทรัพย์สินเสียหาย หรืออาจเป็นเหตุให้ถูกไฟฟ้าดูดได้**
- ▶ **ปลดสวิตช์เปิด-ปิดและสับสวิตช์ไปที่ตำแหน่งปิดเมื่อการจ่ายกระแสไฟฟ้าหยุดชะงัก ต. ย. เช่น ในกรณีที่ใช้ปลั๊กหรือปลั๊กไฟฟ้าหลักถูกดึงออก** ในลักษณะนี้จะช่วยป้องกันไม่ให้เครื่องติดสวิตช์อีกครั้งอย่างควบคุมไม่ได้
- ▶ **ฝุ่นที่ได้จากวัสดุ เช่น เคลือบผิวที่มีตะกั่ว ไม้บางประเภท แร่ธาตุ และโลหะ อาจเป็นอันตรายต่อสุขภาพและทำให้เกิดอาการแพ้ นำไปสู่โรคติดเชื้อในระบบหายใจ และ/หรือโรคเมะเร็ง** ผู้ทำงานกับวัสดุผสมแอสเบสทอสได้ต้องเป็นช่างผู้เชี่ยวชาญเท่านั้น
 - ใช้ระบบดูดฝุ่นออกที่เหมาะสมกับประเภทวัสดุ มากเท่าที่จะทำได้
 - จัดสถานที่ทำงานให้มีการระบายอากาศที่ดี
 - ขอแนะนำให้สวมหน้ากากป้องกันการติดเชื้อที่มีระดับ-ไส้กรอง P2
 ปฏิบัติตามกฎข้อบังคับสำคัญอื่นๆ ที่เกี่ยวกับวัสดุชิ้นงานที่บังคับใช้ในประเทศของท่าน
- ▶ **ป้องกันการสะสมของฝุ่นในสถานที่ทำงาน** ฝุ่นสามารถถูกไหม้อย่างง่ายดาย
- ▶ **ยึดชิ้นงานให้แน่น** การยึดชิ้นงานด้วยเครื่องหนีบหรือแท่นจับจะมั่นคงกว่าการยึดด้วยมือ

- ▶ หากงานขัดแตกหักขณะปฏิบัติงาน หรืออุปกรณ์จับยึดบนกระบ้งป้องกันอันตราย/เครื่องมือไฟฟ้าเกิดชำรุดต้องส่งเครื่องไปซ่อมบำรุงที่ศูนย์บริการหลังการขายในทันที (สำหรับที่อยู่ ดูบท "การบริการหลังการขายและคำแนะนำการใช้งาน")
- ▶ **ปรับกระบ้งป้องกันอันตรายในลักษณะปกป้องประกายไฟไม่ให้แลบเข้าหาผู้ใช้เครื่อง**
- ▶ **กระบ้งป้องกันอันตรายสามารถหมุนได้เฉพาะเมื่อกดคันโยกปลดบนหัวเกียร์เท่านั้น** ถ้าไม่เป็นเช่นนั้นท่านอย่าใช้เครื่องอีกต่อไป และต้องส่งเครื่องไปซ่อมบำรุงที่ศูนย์บริการหลังการขาย
- ▶ **อย่าแตะต้องจานตัดและงานขัดจนกว่าจะเย็นลง** ขณะทำงาน จานจะร้อนมาก
- ▶ **กดปุ่มล็อคแกนเมื่อเครื่องขัดหยุดนิ่งอยู่กับที่เท่านั้น** มิฉะนั้น เครื่องอาจชำรุดได้
- ▶ **เมื่อประกอบเครื่องมือขัดเข้าแล้ว ก่อนเปิดสวิตซ์ทำงานให้ตรวจสอบว่าได้ใส่เครื่องมือขัดเข้าอย่างถูกต้องแล้ว และเครื่องมือสามารถหมุนได้อย่างอิสระ** ดูให้แน่ใจว่าเครื่องมือขัดไม่ครูดกับกระบ้งป้องกันอันตรายหรือส่วนอื่นๆ
- ▶ **หากใช้เครื่องทำงานด้วยพลังงานจากเครื่องกำเนิดไฟฟ้าเคลื่อนที่** เมื่อเปิดสวิตซ์เครื่อง เครื่องอาจสูญเสียประสิทธิภาพหรือทำงานผิดปกติได้
- ▶ **เมื่อใช้กำลังทำงานมากเกินไป เครื่องอาจถูกใช้งานเกินพิกัด** การทำงานเกินพิกัดจะทำให้เครื่องร้อนเกินไปและเสียหายได้ หลังเครื่องมือไฟฟ้าทำงานหนัก ให้ปล่อยให้เครื่องวิ่งตัวเปล่านานหลายนาทีเพื่อให้เครื่องเย็นลง
- ▶ **อย่าใช้เครื่องมือไฟฟ้าร่วมกับแท่นตัดออก**
- ▶ **ห้ามนำจานตัดมาใช้สำหรับกัดผิวหยาบอย่างเด็ดขาด**
- ▶ **ใช้น็อตเกลียวแบบขันเร็วได้เฉพาะกับจานตัดและงานขัดเท่านั้น** ใช้เฉพาะน็อตเกลียวแบบขันเร็วที่ไม่มีตำหนิและชำรุดเสียหายเท่านั้น
- ▶ **อย่าดึงหัวเกียร์ออกขณะกำลังหมุนหัวเกียร์อยู่** – ดูภาพประกอบ 12 หน้า 70

สัญลักษณ์

สัญลักษณ์ต่อไปนี้มีความสำคัญต่อการอ่านและการทำความเข้าใจคู่มือการใช้งานเครื่อง กรุณาจดจำสัญลักษณ์และความหมายของสัญลักษณ์ การแปลความสัญลักษณ์ได้ถูกต้องจะช่วยให้ท่านใช้เครื่องได้ดีและปลอดภัยกว่า

สัญลักษณ์	ความหมาย
	หมายเลขสินค้า
	ต้องอ่านค่าเตือนเพื่อความปลอดภัยและคำสั่งทั้งหมด
	ดึงปลั๊กไฟออกจากเต้าเสียบก่อนปรับแต่งเครื่อง
	ต้องสวมถุงมือป้องกัน
	ต้องสวมอุปกรณ์ป้องกันหู
	ต้องสวมแว่นตานิรภัย/แว่นครอบตา
	ทิศทางการเคลื่อนที่
	ใช้พลังกำลังสำหรับขั้นตอนการทำงาน
	ความเร็วต่ำ
	ความเร็วสูง
	เปิดเครื่องทำงาน
	ปิดเครื่อง
	สวิตช์เปิด-ปิด ล็อคไว้
	ปลดฟังก์ชันล็อคของสวิตช์เปิด-ปิด
	การกระทำที่ห้าม
	การกระทำที่อนุญาต
	ขั้นตอนการกระทำต่อไป
P ₁	กำลังไฟฟ้าเข้ากำหนด
P ₂	กำลังไฟฟ้าออก

Bosch Power Tools

สัญลักษณ์	ความหมาย
n	ความเร็วรอบกำหนด
n _v	การปรับส่วนควบคุมความเร็วรอบ
	l = ความยาวแกนเครื่องขัด d ₁ = เส้นผ่าศูนย์กลางแกนเครื่องขัด D = เส้นผ่าศูนย์กลางจานขัดสูงสุด d ₂ = เส้นผ่าศูนย์กลางด้านโนจาน
	การตั้งความเร็วรอบล่วงหน้า
	การควบคุมค่าคงที่ด้วยระบบอิเล็กทรอนิกส์
	การยับยั้งการตีกลับ
	การป้องกันการสตาร์ทที่อีกครั้ง
	การจำกัดกระแสไฟฟ้าเมื่อสตาร์ทเครื่อง
	ข้อมูลเพิ่มเติม
	การเจียรในพื้นผิว
	การเจียรใน/ขัดด้วยกระดาษทราย
	น้ำหนักตามระเบียบการ EPTA-01:2014 พร้อมด้ามจับเพิ่มลดการสั่นสะเทือน
	น้ำหนักตามระเบียบการ EPTA-01:2014 พร้อมด้ามจับเพิ่มมาตรฐาน
	สัญลักษณ์สำหรับระดับความปลอดภัย II (ห่อหุ้มด้วยฉนวนทั้งหมด)

รายการสิ่งของที่จัดส่ง

เครื่องขัดมุม กระจกป้องกันอันตราย ด้ามจับเพิ่ม กระจกป้องกันอันตรายพิเศษ เครื่องมือ และอุปกรณ์ประกอบอื่นๆ ที่แสดงหรือระบุไม่รวมอยู่ในการจัดส่งมาตรฐาน กรุณาดูการอธิบายโดยสรุปทั้งหมดในโปรแกรมอุปกรณ์ประกอบของเรา

1 609 92A 1UV | (16.1.17)

36 | ภาษาไทย

ประโยชน์การใช้งานของเครื่อง

เครื่องนี้ใช้สำหรับกัดหยาบวัสดุที่เป็นโลหะ หิน และเซรามิก และสำหรับเจาะกระเบื้อง

สำหรับการตัดด้วยอุปกรณ์ทำจากวัสดุขัดถูชนิดที่ใช้ตัวประสาน (bonded abrasives) ต้องใช้แผ่นนำการตัดพิเศษ (อุปกรณ์ประกอบ)

เมื่อตัดในหิน ต้องจัดเตรียมให้มีการดูดฝุ่นออกอย่างพอเพียงร่วมกับกระบังป้องกันมือ (อุปกรณ์ประกอบ) ท่านสามารถใช้เครื่องนี้สำหรับแปร่ง และขัดโดยใช้แผ่นหนูนขัดที่ยืดหยุ่น เครื่องนี้เหมาะสำหรับการทำงานโดยไม่ใช้น้ำเท่านั้น

ข้อมูลทางเทคนิค











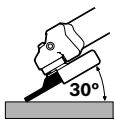

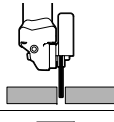
ข้อมูลทางเทคนิคของเครื่องได้ลงรายการไว้ในตารางหน้า 55 - 56 ของคู่มือการใช้งานเครื่องเล่มนี้

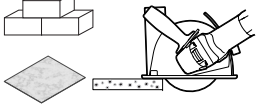

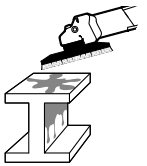



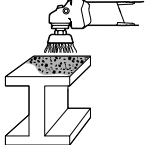



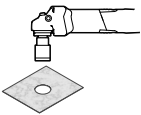

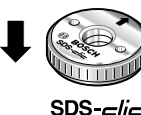
ค่าที่ให้นี้ใช้ได้กับแรงดันไฟฟ้าระบุ [U] 230 โวลต์ ค่าเหล่านี้อาจผิดแผกไปสำหรับแรงดันไฟฟ้าที่ต่ำกว่า และโมเดลที่สร้างสำหรับเฉพาะประเทศ

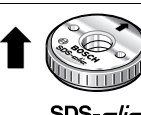
เครื่องแต่ละเครื่องอาจมีชื่อทางการค้าแตกต่างกัน ดังนั้นกรุณาสังเกตหมายเลขสินค้าบนแผ่นป้ายรุ่นของเครื่องของท่าน

การประกอบและการปฏิบัติงาน

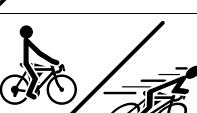
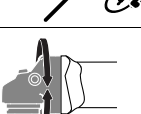
ตารางต่อไปนี้แสดงขั้นตอนการติดตั้งและการทำงานของเครื่องมือไฟฟ้า คำแนะนำสำหรับแต่ละขั้นตอนจะแสดงในภาพประกอบด้านข้าง อาจต้องใช้คำแนะนำหลากหลายรวมกันทั้งนี้ขึ้นอยู่กับประเภทการใช้งาน ปฏิบัติตามคำแนะนำเพื่อความปลอดภัย

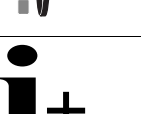
ขั้นตอน	ภาพประกอบ	กรุณาปฏิบัติตาม	หน้า
การเตรียมความพร้อม การขัด			57–58
การเตรียมความพร้อม การตัด			59–60
การเตรียมความพร้อม การตัดหิน อิฐและ กระเบื้อง (ข้อแนะนำ)			61–62
การเตรียมความพร้อม การขัดพร้อม ฝาครอบดูดออก			63–64
การเตรียมความพร้อม การเอาสีออก			65
การเตรียมความพร้อม การเอาสนิมออก			66

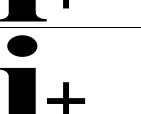
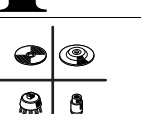
ขั้นตอน	ภาพประกอบ	กรุณาปฏิบัติตาม	หน้า
การเตรียมความพร้อม การเจาะกระเบื้อง			67
การประกอบน็อตเกลียว ยว แบบขันเร็ว			67–68
การถอดน็อตเกลียว แบบขันเร็ว			68
การเปิดและปิดสวิตช์			68
การตั้งความเร็วรอบ เลือกล่วงหน้า			69
การหมุนหัวเครื่อง			70
การทำงานอย่างมี ประสิทธิภาพ ด้วยเครื่องขัดมุม			71
บริเวณสีเทา: ด้ามจับ (พื้นผิวจับหุ้มด้วยฉนวน)			71
การเลือกเครื่องมือ ขัดที่อนุญาต			72
การเลือกอุปกรณ์ ประกอบ			73–75

การบำรุงรักษาและการทำความสะอาด

- ▶ เพื่อให้ทำงานได้อย่างถูกต้องและปลอดภัย ต้องรักษาเครื่องและช่องระบายอากาศให้สะอาดอยู่เสมอ
- หากใช้เครื่องทำงานหนัก ให้ใช้อุปกรณ์ดูดฝุ่นออกเท่าที่จะทำได้เสมอ เป่าช่องระบายอากาศเป็นประจำ

และติดตั้งสวิตซ์ตัดวงจรเมื่อเกิดการรั่วไหลของไฟฟ้าจากสายดิน (RCD) เมื่อทำงานกับโลหะ ฝุ่นซึ่งมีคุณสมบัติ นำความร้อนและกระแสไฟฟ้าอาจสะสมอยู่ข้างใน เครื่องมือไฟฟ้า ฉนวนป้องกันทั้งหมดของเครื่องมือไฟฟ้า อาจได้รับผลเสีย

กรุณาเก็บรักษาและจับถืออุปกรณ์ประกอบอย่างระมัดระวัง

38 | Bahasa Indonesia

เมื่อจำเป็นต้องเปลี่ยนสายไฟฟ้า ให้ส่งเครื่องให้บริษัท บ็อชหรือศูนย์บริการลูกค้าสำหรับเครื่องมือไฟฟ้า บ็อช ที่ได้รับมอบหมายทำการเปลี่ยนให้ เพื่อหลีกเลี่ยงอันตรายด้านความปลอดภัย

การบริการหลังการขายและคำแนะนำการใช้งาน

ศูนย์บริการหลังการขายของเรายินดีตอบคำถามเกี่ยวกับการบำรุงรักษาและการซ่อมแซมผลิตภัณฑ์ของท่าน รวมทั้งชิ้นส่วนอะไหล่ ภาพแยกชิ้นประกอบและข้อมูลเกี่ยวกับชิ้นส่วนอะไหล่ยังสามารถดูได้ใน:

www.bosch-pt.com

ทีมงานให้คำแนะนำการใช้งานของ บ็อช ยินดีตอบคำถามเกี่ยวกับผลิตภัณฑ์ของเราและอุปกรณ์ประกอบของผลิตภัณฑ์ เมื่อต้องการสอบถามและสั่งซื้ออะไหล่ กรุณาแจ้งหมายเลขสินค้าลับหลักบนแผ่นป้ายรุ่นของเครื่องทุกครั้ง ในกรณีประกัน ซ่อมแซม หรือซื้อชิ้นส่วนมาเปลี่ยน กรุณาติดต่อ ผู้ขายที่ได้รับแต่งตั้งเท่านั้น

ไทย

บริษัท โรเบิร์ต บ็อช จำกัด
ชั้น 11 ตึกลิเบอร์ตี สแควร์
287 ถนนสีลม บางรัก
กรุงเทพฯ 10500
โทรศัพท์ 02 6393111, 02 6393118
โทรสาร 02 2384783
บริษัท โรเบิร์ต บ็อช จำกัด ตู้ ปณ. 2054
กรุงเทพฯ 10501 ประเทศไทย
www.bosch.co.th

ศูนย์บริการซ่อมและฝึกอบรม บ็อช
อาคาร ลาซาลทาวเวอร์ ชั้น G ห้องเลขที่ 2
บ้านเลขที่ 10/11 หมู่ 16
ถนนศรีนครินทร์
ตำบลบางแก้ว อำเภอบางพลี
จังหวัดสมุทรปราการ 10540
ประเทศไทย
โทรศัพท์ 02 7587555
โทรสาร 02 7587525

การกำจัดขยะ

เครื่องมือ อุปกรณ์ประกอบ และที่บด ต้องนำไปแยกประเภทวัสดุเพื่อนำกลับมาใช้ใหม่โดยไม่ทำลายสภาพแวดล้อม อย่างไรก็ตาม เครื่องมือไฟฟ้าลงในขยะบ้าน!

ขอสงวนสิทธิ์ในการเปลี่ยนแปลงโดยไม่ต้องแจ้งล่วงหน้า

Bahasa Indonesia

Petunjuk-Petunjuk Umum untuk Perkakas Listrik

⚠ PERHATIKANLAH Bacalah semua petunjuk-petunjuk untuk keselamatan kerja dan petunjuk-petunjuk untuk penggunaan.

Kesalahan dalam menjalankan petunjuk-petunjuk untuk keselamatan kerja dan petunjuk-petunjuk untuk penggunaan dapat mengakibatkan kontak listrik, kebakaran dan/atau luka-luka yang berat.

Simpanlah semua petunjuk-petunjuk untuk keselamatan kerja dan petunjuk-petunjuk lainnya untuk penggunaan di masa depan.

Kata „perkakas listrik“ yang disebutkan di dalam petunjuk-petunjuk untuk keselamatan kerja adalah sebutan untuk perkakas listrik pakai listrik jaringan (dengan kabel) dan untuk perkakas listrik tenaga baterai (tanpa kabel listrik).

Keselamatan kerja di tempat kerja

- ▶ **Jagalah supaya tempat kerja selalu bersih dan terang.** Tempat kerja yang tidak rapi atau tidak terang dapat mengakibatkan terjadinya kecelakaan.
- ▶ **Janganlah menggunakan perkakas listrik di tempat di mana dapat terjadi ledakan, di mana ada cairan, gas atau debu yang mudah terbakar.** Perkakas listrik dapat memancarkan bunga api yang lalu mengakibatkan debu atau uap terbakar.
- ▶ **Selama menggunakan perkakas listrik, jauhkan anak-anak dan orang-orang lain dari tempat kerja.** Jika konsentrasi terganggu, bisa jadi Anda tidak bisa mengendalikan perkakas listrik tersebut.

Keamanan listrik

- ▶ **Steker dari perkakas listrik harus cocok pada stopkontak. Janganlah sekali-kali merubah steker.** Janganlah menggunakan steker perantara bersama dengan perkakas listrik yang mempunyai hubungan arde. Steker yang tidak dirubah dan stopkontak yang cocok mengurangi bahaya terjadinya kontak listrik.
- ▶ **Jagalah supaya badan Anda tidak bersentuhan dengan permukaan yang mempunyai hubungan arde, misalnya pipa-pipa, radiator pemanas ruangan, kompor listrik dan lemari es.** Ada risiko besar terjadi kontak listrik, jika badan Anda mempunyai hubungan arde.
- ▶ **Jagalah supaya perkakas listrik tidak kena hujan atau menjadi basah.** Air yang masuk ke dalam perkakas listrik menambah risiko terjadinya kontak listrik.
- ▶ **Janganlah menyalah gunakan kabel listrik untuk mengangkat dan menggantungkan perkakas listrik atau untuk menarik steker dari stopkontak. Jagalah supaya kabel listrik tidak kena panas, minyak, pinggiriran yang tajam atau bagian-bagian perkakas yang bergerak.** Kabel listrik yang rusak atau tersangkut menambah risiko terjadinya kontak listrik.

- ▶ **Jika Anda menggunakan perkakas listrik di luar gedung, gunakanlah hanya kabel sambungan yang juga cocok untuk pemakaian di luar gedung.** Penggunaan kabel sambungan yang cocok untuk pemakaian di luar gedung mengurangi risiko terjadinya kontak listrik.
- ▶ **Jika penggunaan perkakas listrik di tempat yang basah tidak bisa dihindarkan, gunakanlah sakelar pengaman terhadap arus penyimpangan.** Penggunaan sakelar pengaman terhadap arus penyimpangan mengurangi risiko terjadinya kontak listrik.

Keselamatan kerja

- ▶ **Berhati-hatilah selalu, perhatikanlah apa yang Anda kerjakan dan bekerjalah dengan seksama jika menggunakan perkakas listrik. Janganlah menggunakan perkakas listrik, jika Anda capai atau berada di bawah pengaruh narkoba, minuman keras atau obat.** Jika Anda sekejap mata saja tidak berhati-hati sewaktu menggunakan perkakas listrik, dapat terjadi luka-luka berat.
- ▶ **Pakailah pakaian dan sarana pelindung dan pakailah selalu kaca mata pelindung.** Dengan memakai pakaian dan sarana pelindung, misalnya kedok anti debu (masker), sepatu tertutup yang tidak licin, helm pelindung atau pemalut telinga sesuai dengan pekerjaan yang dilakukan dengan perkakas listrik, bahaya terjadinya luka-luka dapat dikurangi.
- ▶ **Jagalah supaya perkakas listrik tidak dihidupkan secara tidak disengaja. Perhatikan bahwa perkakas listrik dalam penyetelan mati, jika steker disambungkan pada pengadaan listrik dan/atau baterai, jika perkakas listrik diangkat atau dibawa.** Jika selama mengangkat perkakas listrik jari Anda berada pada tombol untuk menghidupkan dan mematikan atau perkakas listrik yang dalam penyetelan hidup disambungkan pada listrik, dapat terjadi kecelakaan.
- ▶ **Lepaskan semua perkakas-perkakas penyetelan atau kunci-kunci pas sebelum perkakas listrik dihidupkan.** Perkakas atau kunci yang berada di dalam bagian yang berputar dapat mengakibatkan terjadinya luka-luka.
- ▶ **Aturkan badan sedemikian sehingga Anda bisa bekerja dengan aman. Berdirilah secara mantap dan jagalah selalu keseimbangan.** Dengan demikian Anda bisa mengendalikan perkakas listrik dengan lebih baik, jika terjadi sesuatu dengan tiba-tiba.
- ▶ **Pakailah pakaian yang cocok. Janganlah memakai pakaian yang longgar atau perhiasan. Jagalah supaya rambut, pakaian dan sarung tangan tidak masuk dalam bagian-bagian perkakas yang bergerak.** Pakaian yang longgar, rambut panjang atau perhiasan dapat tersangkut dalam bagian perkakas yang bergerak.
- ▶ **Jika ada kemungkinan untuk memasang sarana penghisapan dan penampungan debu, perhatikan bahwa sarana-sarana ini telah dipasangkan dan digunakan dengan betul.** Penggunaan sarana penghisapan bisa mengurangi bahaya yang disebabkan debu.

Penggunaan dan penanganan perkakas listrik dengan seksama

- ▶ **Janganlah membebankan perkakas listrik terlalu berat. Gunakan selalu perkakas listrik yang cocok untuk pekerjaan yang dilakukan.** Dengan perkakas listrik yang cocok Anda bekerja lebih baik dan lebih aman dalam batas-batas kemampuan yang ditentukan.
- ▶ **Janganlah menggunakan perkakas listrik yang tombolnya rusak.** Perkakas listrik yang tidak bisa dihidupkan atau dimatikan, berbahaya dan harus direparasikan.
- ▶ **Tariklah steker dari stopkontak dan/atau keluarkan baterai, sebelum Anda melakukan penyetelan pada perkakas listrik, mengganti alat-alat kerja atau sebelum menyimpan perkakas listrik.** Tindakan keselamatan kerja ini mengurangi bahaya perkakas listrik hidup secara tidak disengaja.
- ▶ **Simpanlah perkakas listrik yang tidak digunakan di luar jangkauan anak-anak. Janganlah mengizinkan orang-orang yang tidak mengenal perkakas listrik ini atau yang belum membaca petunjuk-petunjuk ini, menggunakan perkakas listrik ini.** Perkakas listrik bisa menjadi berbahaya, jika digunakan oleh orang-orang yang tidak mengenalnya.
- ▶ **Rawatlah perkakas listrik dengan seksama. Periksa, apakah bagian-bagian perkakas listrik yang bergerak berfungsi dengan baik dan tidak tersangkut, apakah ada bagian-bagian yang patah atau rusak sedemikian, sehingga dapat mempengaruhi jalannya perkakas listrik. Biarkan bagian-bagian perkakas yang rusak direparasikan, sebelum Anda mulai menggunakan perkakas listrik.** Banyak kecelakaan terjadi karena perkakas listrik tidak dirawat dengan seksama.
- ▶ **Perhatikan supaya alat-alat pemotong selalu tajam dan bersih.** Alat-alat pemotong dengan mata-mata pemotong yang tajam dan dirawat dengan seksama tidak mudah tersangkut dan lebih mudah dikendalikan.
- ▶ **Gunakanlah semua perkakas listrik, aksesori, alat-alat kerja dsb. sesuai dengan petunjuk-petunjuk. Perhatikan syarat-syarat kerja dan macam pekerjaan yang dilakukan.** Penggunaan perkakas listrik untuk macam pekerjaan yang tidak cocok dengan kegunaannya bisa mengakibatkan keadaan yang berbahaya.

Servis

- ▶ **Biarkan perkakas listrik Anda direparasikan hanya oleh orang-orang ahli yang berpengalaman dan hanya dengan menggunakan suku cadang yang asli.** Dengan demikian terjamin keselamatan kerja dengan perkakas listrik ini secara berkesinambungan.

Petunjuk-petunjuk untuk keselamatan kerja untuk mesin gerinda tangan

Petunjuk-petunjuk untuk keselamatan kerja yang sama untuk pekerjaan menggerinda, mengampelas dengan kertas pasir, bekerja dengan sikat kawat dan memotong

- ▶ **Perkakas listrik ini bisa digunakan sebagai mesin gerinda, mesin ampelas dengan kertas pasir, sikat kawat dan sebagai mesin potong. Perhatikanlah semua petunjuk-petunjuk untuk keselamatan kerja, petunjuk-petunjuk untuk penggunaan, gambar-gambar dan data-data yang Anda terima bersama dengan perkakas listrik.** Jika Anda tidak menaati petunjuk-petunjuk berikut, bisa terjadi kontak listrik, kebakaran dan/atau luka-luka berat.
 - ▶ **Perkakas listrik ini tidak cocok untuk pekerjaan memolis.** Pemakaian perkakas listrik untuk pekerjaan yang tidak cocok dengan tujuannya bisa mengakibatkan keadaan yang membahayakan dan terjadinya luka-luka.
 - ▶ **Gunakanlah hanya aksesori yang dirancang khusus untuk perkakas listrik ini dan dianjurkan oleh Bosch.** Jika suatu aksesori bisa dipasangkan pada perkakas listrik milik Anda, ini tidak berarti bahwa penggunaannya yang aman terjamin.
 - ▶ **Kecepatan putaran yang diizinkan dari alat kerja harus paling sedikit sebesar kecepatan putaran maksimal yang tercantum pada perkakas listrik.** Aksesori yang diputar lebih cepat daripada kecepatan putaran yang diizinkan, bisa terpatah dan beterbangan.
 - ▶ **Diameter luar dan ketebalan alat kerja harus sesuai dengan ukuran-ukuran yang dianjurkan bagi perkakas listrik milik Anda.** Alat kerja-alat kerja yang tidak cocok ukurannya tidak bisa dilindungi atau dikendalikan dengan baik.
 - ▶ **Alat kerja-alat kerja berulir harus duduk pas pada uliran dari poros kerja. Pada alat kerja-alat kerja yang dipasangkan dengan flens, diameter lubang dari alat kerja harus cocok pada diameter lubang dari flens.** Alat kerja-alat kerja yang tidak dikencangkan dengan baik pada perkakas listrik berputar tidak sempurna karena tidak balans, bervibrasi keras sekali dan bisa membuat perkakas listrik tidak bisa dikendalikan.
 - ▶ **Janganlah menggunakan alat kerja-alat kerja yang tidak mulus. Sebelum digunakan, periksalah selalu alat kerja-alat kerja seperti mata gerinda diperiksa apakah ada bagian yang sembul dan retak, piringan diperiksa apakah retak, aus atau tumpul, sikat kawat diperiksa apakah ada kawat yang terlepas atau putus. Jika perkakas listrik atau alat kerja jatuh, periksalah apakah menjadi rusak atau gunakanlah alat kerja lainnya yang tidak rusak. Jika Anda telah memeriksa alat kerja dan telah memasangkannya, Anda dan orang-orang yang berada di dekat tempat kerja harus menjauh dari lingkungan gerak alat kerja yang memutar dan biarkan perkakas listrik berjalan dengan kecepatan putaran maksimal selama satu menit.**
- Kebanyakan alat kerja-alat kerja yang rusak akan putus selama masa uji coba ini.
- ▶ **Pakailah sarana pelindung bagi diri Anda. Tergantung dari macam pekerjaan yang dilakukan, pakailah kedok penutup muka, pelindung mata atau kaca mata pelindung. Jika perlu, pakailah kedok anti debu, pemalut telinga, sarung tangan pelindung atau pakaian pelindung khusus yang melindungi Anda dari butir-butir gerinda dan butir-butir bahan (serbuk).** Mata harus dilindungi terhadap benda-benda yang beterbangan, yang terjadi pada beberapa macam pemakaian perkakas listrik. Kedok anti debu atau kedok pelindung pernafasan harus mampu menyaring debu yang terjadi selama pemakaian perkakas listrik. Jika Anda mendengar suara bising untuk waktu yang lama, daya pendengaran bisa berkurang.
 - ▶ **Perhatikanlah supaya orang-orang lain cukup jauh dari tempat kerja Anda. Semua orang yang mendekati tempat kerja Anda harus memakai sarana pelindung badan.** Pecahan-pecahan dari benda yang dikerjakan atau alat kerja-alat kerja yang patah bisa beterbangan dan mengakibatkan luka-luka, juga di tempat yang agak jauh dari lingkungan gerak mesin.
 - ▶ **Peganglah perkakas listrik hanya pada pegangan yang terisolir, jika Anda melakukan pekerjaan di mana alat kerjanya bisa terkena pada saluran listrik yang tidak terlihat atau kabelnya sendiri.** Alat kerja yang bersentuhan dengan kabel yang bertegangan dapat mengakibatkan bagian-bagian logam dari perkakas listrik juga bertegangan dan lalu mengakibatkan kontak listrik.
 - ▶ **Jauhkan kabel listrik dari alat kerja-alat kerja yang berputar.** Jika Anda tidak bisa mengendalikan perkakas listrik, kabel listrik bisa terpotong atau tersangkut dan lalu tangan atau lengan Anda bisa terkena pada alat kerja yang berputar.
 - ▶ **Janganlah meletakkan perkakas listrik jika alat kerjanya belum berhenti sama sekali.** Alat kerja yang masih berputar bisa terkena pada permukaan di mana perkakas listrik diletakkan sehingga Anda tidak bisa mengendalikan perkakas listrik.
 - ▶ **Janganlah membiarkan perkakas listrik hidup jika Anda sedang mengangkatnya.** Pakaian Anda secara tidak disengaja bisa tersangkut pada alat kerja yang berputar dan alat kerja ini bisa menancap dalam badan Anda.
 - ▶ **Bersihkan lubang-lubang ventilasi pada perkakas listrik Anda secara berkala.** Kipas angin motor menarik debu ke dalam rumah dan debu logam dalam jumlah yang besar dan listrik bisa mengakibatkan bahaya.
 - ▶ **Janganlah menggunakan perkakas listrik di dekat bahan-bahan yang mudah terbakar.** Bunga api bisa menyulut bahan-bahan ini.
 - ▶ **Janganlah menggunakan alat kerja-alat kerja yang memerlukan cairan pendingin.** Penggunaan air atau cairan pendingin lainnya bisa mengakibatkan kontak listrik.

Bantingan dan petunjuk-petunjuk khusus

- ▶ Bantingan (kickback) adalah reaksi yang terjadi tiba-tiba jika alat kerja yang berputar tersangkut atau memblok, misalnya mata gerinda, piringan, sikat kawat dsb. Jika alat kerja tersangkut atau memblok, alat kerja berhenti memutar secara tiba-tiba. Dengan demikian perkakas listrik yang tidak bisa dikendalikan terpelanting ke arah yang berlawanan dengan arah putaran alat kerja di tempat di mana alat kerja memblok.

Jika misalnya satu mata gerinda tersangkut atau memblok dalam benda yang dikerjakan, maka pinggiran mata gerinda yang berada di dalam benda yang dikerjakan tersangsang dan bisa mengakibatkan mata gerinda patah atau bantingan. Dalam hal demikian mata gerinda bergerak mendekati atau menjauhi orang yang menggunakan perkakas listrik, tergantung dari arah putaran mata gerinda di tempat di mana mata gerinda memblok. Dalam hal ini mata gerinda bisa patah.

Bantingan adalah akibat dari penggunaan perkakas listrik yang tidak cocok dan tidak betul. Bantingan bisa dihindarkan dengan cara-cara yang diterangkan di bawah ini.

- ▶ Peganglah perkakas listrik dengan baik dan aturkan badan dan lengan-lengan Anda sedemikian, sehingga Anda bisa mengimbangi jika perkakas listrik membanting. Gunakan selalu gagang tambahan jika memang ada, sehingga Anda bisa mengendalikan daya bantingan-daya bantingan atau momen reaksi-momen reaksi sebaik-baiknya pada waktu putaran sedang bertambah. Orang yang menggunakan perkakas listrik bisa mengendalikan bantingan atau daya reaksi-daya reaksi jika orang ini menaati petunjuk-petunjuk untuk keselamatan kerja.
- ▶ Janganlah sekali-kali mendekatkan tangan Anda pada alat kerja-alat kerja yang sedang berputar. Jika perkakas listrik membanting, alat kerja bisa bergerak di atas tangan Anda.
- ▶ Jauhkan badan Anda dari bidang yang terjangkau oleh perkakas listrik yang membanting. Perkakas listrik dibanting dalam arah yang berlawanan dengan arah putaran mata gerinda pada tempat di mana mata gerinda memblok.
- ▶ Bekerjalah dengan sangat hati-hati di sudut-sudut, pinggiran yang tajam dsb. Jagalah supaya alat kerja-alat kerja tidak memantul dari benda yang dikerjakan dan terjepit. Alat kerja yang berputar cenderung terjepit di sudut-sudut, pinggiran yang tajam atau bisa memantul. Ini mengakibatkan perkakas listrik tidak bisa dikendalikan atau mengakibatkan bantingan.
- ▶ Janganlah menggunakan mata gergaji rantai atau mata gergaji yang bergerigi. Alat kerja-alat kerja demikian sering mengakibatkan bantingan atau membuat perkakas listrik tidak bisa dikendalikan.

Petunjuk-petunjuk untuk keselamatan kerja khusus untuk menggerinda dan memotong

- ▶ Gunakanlah selalu hanya alat kerja-alat kerja yang diizinkan untuk perkakas listrik milik Anda dan kap

pelindung yang khusus untuk alat kerja-alat kerja ini. Alat kerja-alat kerja yang tidak khusus untuk perkakas listrik ini tidak bisa ditutupi dan membahayakan.

- ▶ Mata gerinda terpancung harus dipasangkan sedemikian, sehingga bidang penggerindaan tidak menonjol keluar dari pinggiran kap pelindung. Mata gerinda yang tidak dipasangkan dengan betul, yang menonjol keluar dari pinggiran kap pelindung, tidak dapat dilindungi dengan baik.
- ▶ Kap pelindung harus dipasangkan dengan betul pada perkakas listrik dan harus disetelkan sedemikian, sehingga penggunaan perkakas listrik paling aman, artinya bagian alat kerja yang menghadap ke orang yang menggunakan perkakas listrik harus tertutup oleh kap pelindung sebesar mungkin. Kap pelindung harus melindungi orang yang menggunakan perkakas listrik terhadap bahan yang terpatah, persentuhan yang tidak disengaja dengan alat kerja serta bunga api yang dapat menyulut pakaian.
- ▶ Alat kerja-alat kerja hanya boleh digunakan untuk macam penggunaan yang disarankan. Misalnya: janganlah sekali-kali menggerinda dengan sisi samping dari mata potong. Mata potong digunakan untuk mengikis bahan dengan pinggiran dari piringan. Tekanan dari samping pada alat kerja ini bisa mematahkannya.
- ▶ Gunakan selalu flens penjepit-flens penjepit yang mulus dan dalam ukuran dan bentuk yang cocok untuk alat kerja-alat kerja yang Anda pilih. Flens-flens yang cocok menopang mata gerinda dan dengan demikian menghindarkan mata gerinda patah. Flens-flens untuk mata potong bisa jadi berbeda daripada flens-flens untuk mata gerinda lainnya.
- ▶ Janganlah menggunakan mata gerinda yang aus dari perkakas listrik yang lebih besar. Mata gerinda dari perkakas listrik yang lebih besar tidak cocok untuk kecepatan putaran yang lebih tinggi dari perkakas listrik yang lebih kecil dan bisa terpatah karenanya.

Petunjuk-petunjuk untuk keselamatan kerja lainnya khusus untuk memotong

- ▶ Perhatikanlah supaya mata potong tidak memblok dan janganlah menekannya terlalu keras. Janganlah membuat pemotongan yang terlalu dalam. Pembebanan yang terlalu berat pada mata potong meningkatkan pembebanannya dan membuatnya mudah tersangkut atau memblok dan dengan demikian bisa terjadi bantingan atau mata potong patah.
- ▶ Janganlah mendekati lingkungan di depan atau di belakang mata potong yang sedang berputar. Jika Anda menggerakkan mata potong dalam benda yang dikerjakan menjauh dari diri Anda, bisa jadi jika terjadi bantingan perkakas listrik terpelanting ke arah Anda dengan mata potong yang masih berputar.
- ▶ Jika mata potong terjepit atau jika Anda menghentikan sebentar pekerjaan, matikan perkakas listrik dan janganlah menggoyangkannya hingga mata potong berhenti memutar. Janganlah sekali-kali mencoba untuk menarik mata potong yang masih berputar dari

42 | Bahasa Indonesia

jalur pemotongannya, bisa terjadi bantingan.

Periksalah mengapa mata potong terjepit dan betulkan.

- ▶ **Janganlah menghidupkan kembali perkakas listrik, selama perkakas listrik masih berada dalam benda yang dikerjakan. Biarkan mata potong mencapai kecepatan putaran nominal dahulu sebelum Anda melanjutkan pemotongan dengan hati-hati.** Jika tidak, mata potong bisa tersangkut, melompat ke luar dari jalur pemotongan atau mengakibatkan bantingan.
- ▶ **Topangkan pelat-pelat atau benda-benda yang besar yang dikerjakan untuk mengurangi risiko terjadinya bantingan karena mata potong yang terjepit.** Benda-benda yang besar bisa melengkung ke bawah karena beratnya sendiri. Benda yang dikerjakan harus ditopangkan pada kedua sisinya, baik di dekat jalur pemotongan maupun di pinggirannya.
- ▶ **Berhati-hatilah sekali jika melakukan pemotongan „kantong“ di tembok atau tempat-tempat lain yang tidak terlihat bagian dalamnya.** Mata potong yang masuk ke dalam bahan dan tanpa disengaja memotong pipa gas atau pipa air, saluran listrik atau benda-benda lainnya, bisa mengakibatkan bantingan.

Petunjuk-petunjuk untuk keselamatan kerja khusus untuk mengampelas dengan kertas pasir

- ▶ **Janganlah menggunakan daun ampelas yang terlalu besar, melainkan taatilah petunjuk-petunjuk pabrik tentang ukuran daun ampelas.** Daun ampelas yang lebih besar daripada piringan bisa mengakibatkan terjadinya luka-luka, daun ampelas bisa memblok, sobek atau mengakibatkan bantingan.

Petunjuk-petunjuk untuk keselamatan kerja khusus untuk pekerjaan dengan sikat kawat

- ▶ **Perhatikanlah bahwa kawat-kawat bisa terlepas dari sikat kawat, juga dalam pemakaian yang biasa. Janganlah membebani kawat-kawat terlalu berat dengan tekanan yang terlalu besar.** Kawat-kawat yang beterbangan dengan mudahnya bisa menembusi pakaian yang tipis dan/atau kulit kita.
- ▶ **Jika penggunaan kap pelindung diajarkan, perhatikanlah supaya kap pelindung dan sikat kawat tidak bersentuhan.** Diameter piringan sikat dan mangkok sikat kawat bisa menjadi lebih besar karena tekanan atau daya sentrifugal.

Petunjuk-petunjuk lainnya untuk keselamatan kerja dan untuk penggunaan

- ▶ **Perhatikanlah tegangan jaringan listrik! Tegangan jaringan listrik harus sesuai dengan tegangan listrik yang tercantum pada label tipe perkakas listrik.**
- ▶ **Gunakanlah alat detektor logam yang cocok untuk mencari kabel dan pipa yang tidak terlihat atau hubungan perusahaan pengadaan setempat.** Sentuhan dengan kabel-kabel listrik dapat mengakibatkan api dan

kontak listrik. Pipa gas yang dirusak dapat mengakibatkan ledakan. Pipa air yang dirusak mengakibatkan kerusakan barang-barang atau dapat mengakibatkan kontak listrik.

- ▶ **Buka penguncian tombol untuk menghidupkan dan mematikan dan setelkan tombol pada penyetelan mati, jika pengadaan listrik terputus, misalnya jika listrik mati atau steker ditarik dari stopkontak.** Dengan demikian perkakas listrik tidak hidup kembali secara tidak terkendali.
- ▶ **Debu dari berbagai bahan misalnya cat yang mengandung timbel, beberapa jenis kayu, bahan mineral dan logam bisa berbahaya bagi kesehatan dan mengakibatkan reaksi alergi, penyakit saluran pernafasan dan/atau kanker.** Bahan-bahan yang mengandung asbestos hanya boleh dikerjakan oleh orang-orang ahli yang berpengalaman.
 - Gunakanlah hanya penghisap debu yang cocok untuk menghisap bahan yang dikerjakan.
 - Perhatikanlah supaya ada pertukaran udara di tempat kerja.
 - Kami anjurkan supaya Anda memakai kedok anti debu dengan saringan (filter) kelas P2.
 Taatilah peraturan-peraturan untuk bahan-bahan yang dikerjakan yang berlaku di negara Anda.
- ▶ **Hindari debu yang banyak terkumpul di tempat kerja.** Debu dapat menyulut dengan mudahnya.
- ▶ **Usahakan supaya benda yang dikerjakan tidak goyang.** Benda yang ditahan dalam alat pemegang atau bais lebih mantap daripada benda yang dipegang dengan tangan.
- ▶ **Jika mata gerinda selama penggunaan patah atau jika pemegang-pemegang pada kap pelindung/pada perkakas listrik rusak, perkakas listrik harus segera dikirimkan ke Service Center layanan pasca beli, alamat lihat bab „Layanan pasca beli dan konseling terkait pengoperasian“.**
- ▶ **Setelkan kap pelindung sedemikian, sehingga terhindarkan pemancaran bunga api dalam arah orang yang menggunakan perkakas listrik.**
- ▶ **Hanya jika tuas pembuka kunci pada kepala mesin digerakkan, kap pelindung dapat diputar.** Jika berlainan dari hal ini, perkakas listrik sama sekali tidak boleh dioperasikan dan harus diserahkan kepada Service Center.
- ▶ **Janganlah memegang mata gerinda dan mata mata potong, jika masih belum menjadi dingin.** Piringan-piringan ini menjadi sangat panas selama penggunaannya.
- ▶ **Tombol penahan poros kerja hanya boleh digerakkan jika poros kerja tidak berputar.** Jika tidak demikian, perkakas listrik bisa menjadi rusak.
- ▶ **Setelah memasang alat kerja-alat kerja dan sebelum menghidupkan perkakas, periksalah apakah alat kerja-alat kerja sudah dipasangkan dengan betul dan dapat berputar secara bebas.** Perhatikanlah supaya alat kerja tidak menyinggung kap pelindung atau bagian-bagian lainnya.
- ▶ **Jika perkakas listrik disambungkan pada pembangkit listrik yang mobil (generator), pada waktu perkakas listrik dihidupkan bisa jadi daya berkurang atau terjadi hal-hal yang tidak lazim.**

- ▶ Tekanan yang terlalu besar dapat membebani perkakas listrik terlalu berat. Pembebanan yang terlalu berat dapat mengakibatkan pemanasan dan merusakkan perkakas listrik. Setelah pembebanan yang besar, biarkan perkakas listrik beroperasi tanpa beban selama beberapa menit, untuk mendinginkan perkakas listrik.
- ▶ Janganlah menggunakan perkakas listrik dengan pesawat penopang untuk mesin gerinda potong.
- ▶ Janganlah sekali-kali menggunakan mata potong untuk mengikis.
- ▶ Mur yang dibuka dan dikunci dengan tangan hanya boleh digunakan untuk mata gerinda dan mata potong. Gunakanlah hanya mur yang dibuka dan dikunci dengan tangan yang mulus dan tidak rusak.
- ▶ Pada waktu memutar kepala mesin, janganlah menariknya keluar – lihat gambar 12, halaman 70.





Simbol-Simbol

Simbol-simbol berikut penting pada waktu membaca dan untuk mengerti petunjuk-petunjuk untuk penggunaan. Lihat dan ingati simbol-simbol dan artinya. Penafsiran yang betul dari simbol-simbol sangat membantu Anda untuk menggunakan perkakas listrik dengan jitu dan sesuai dengan petunjuk untuk keselamatan kerja.

Simbol	Arti
	Nomor model
	Bacalah semua petunjuk-petunjuk untuk keselamatan kerja dan petunjuk-petunjuk untuk penggunaan
	Sebelum melakukan semua pekerjaan pada perkakas listrik, tarikkan steker dari stopkontak
	Pakailah sarung tangan pelindung
	Pakailah pemalut telinga.
	Pakailah kaca mata pelindung
	Arah gerakan
	Lakukanlah pekerjaan ini dengan tenaga yang besar.

Simbol	Arti
	Kecepatan putaran rendah
	Kecepatan putaran tinggi
I	Menghidupkan perkakas listrik
O	Mematikan perkakas listrik
	Mengunci tombol untuk menghidupkan dan mematikan
	Melepaskan penguncian tombol untuk menghidupkan dan mematikan
X	Kegiatan yang dilarang
	Kegiatan yang diizinkan
	Kegiatan berikut
P_1	Masukan nominal
P_2	Daya
n	Kecepatan putaran nominal
n_v	Bidang penyetelan kecepatan putaran
	l = panjang poros kerja d_1 = diameter poros kerja
	D = diameter maks. mata gerinda d_2 = diameter lubang mata gerinda
	Penyetelan pendahuluan kecepatan putaran
	Elektronika penyetap putaran
	Kickback stop (Pengaman terhadap bantingan)
KICK BACK STOP	
	Penghindar hidup ulang
	Pembatasan arus listrik pada awalan start
i+	Informasi tambahan
	Mengerinda permukaan

44 | Bahasa Indonesia

Simbol	Arti
	Menggerinda dengan daun ampelas
 1	Berat sesuai dengan EPTA-Procedure 01:2014 dengan gagang tambahan yang meredam getaran
 2	Berat sesuai dengan EPTA-Procedure 01:2014 dengan gagang tambahan standar
 / II	Simbol dari klasifikasi keamanan II (isolasi perlindungan yang lengkap)

Pasokan standar

Mesin gerinda tangan, kap pelindung, gagang tambahan. Kap pelindung-kap pelindung khusus, alat kerja dan aksesoris lainnya yang ada pada gambar atau yang dijelaskan, tidak termasuk pasokan standar.

Semua aksesoris yang tersedia dapat Anda lihat di dalam program aksesoris.

Penggunaan alat

Perkakas listrik ini cocok untuk mengikis bahan-bahan logam, batu-batuan dan keramik dan untuk membor batu ubin. Untuk memotong dengan mata gerinda, harus dipasangkan satu kap pelindung untuk memotong yang khusus. Untuk memotong batu-batuan harus disediakan penghisapan debu yang memadai. Bersama dengan pelindung tangan (aksesori), perkakas listrik ini dapat digunakan untuk menyikat dan menggerinda dengan piringan yang elastis. Perkakas listrik ini hanya cocok untuk melakukan pekerjaan tanpa menggunakan air.

Data teknis









Data-data teknis dari produk ini tertera di dalam tabel pada halaman 55 - 56 dari petunjuk-petunjuk untuk penggunaan ini.

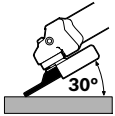

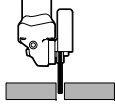

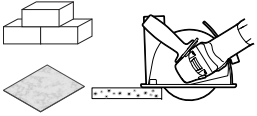





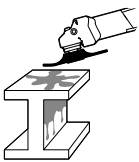

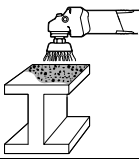

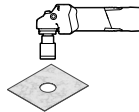



Data-data berlaku untuk tegangan nominal [U] 230 V. Pada tegangan yang lebih rendah dan pada model khusus mancanegara data-data ini bisa berlainan.

Perhatikanlah nomor model perkakas listrik Anda yang tercantum pada label tipe mesin. Nama dagang dari beberapa perkakas listrik bisa berbeda.

Memasang dan menggunakan

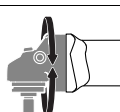
Tabel berikut ini menunjukkan tujuan dari kegiatan pemasangan dan pengoperasian perkakas listrik. Petunjuk-petunjuk untuk tujuan dari kegiatan dijelaskan dengan gambar-gambar. Tergantung dari jenis pengoperasian, dibutuhkan berbagai kombinasi yang berbeda dari petunjuk-petunjuk. Taatilah petunjuk-petunjuk untuk keselamatan kerja.

Kegiatan	Gambar	Perhatikanlah	Halaman
Mempersiapkan penggerindaan			57 - 58
Mempersiapkan pemotongan			59 - 60
Mempersiapkan pemotongan batu dan batu ubin (saran)			61 - 62
Mempersiapkan penggerindaan dengan kap penghisap			63 - 64

Kegiatan	Gambar	Perhatikanlah	Halaman
Mempersiapkan untuk menghilangkan cat			65
Mempersiapkan untuk menghilangkan karat			66
Mempersiapkan untuk membor batu ubin			67
Memasang mur yang dibuka dan dikunci dengan tangan	 ↓  SDS- <i>plus</i>		67 – 68
Melepaskan mur yang dibuka dan dikunci dengan tangan	 ↑  SDS- <i>plus</i>		68
Menghidupkan/mematikan			68
Menyetel penyetelan pendahuluan kecepatan putaran			69
Memutar kepala mesin			70
Pekerjaan yang efektif dengan mesin gerinda tangan			71
Bidang berwarna abu-abu: gagang (permukaan yang dipegang dengan isolasi)			71

46 | Tiếng Việt

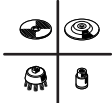
Kegiatan	Gambar	Perhatikanlah	Halaman
Memilih alat kerja yang diizinkan		15	72
Memilih aksesoris	-	-	73 - 75

Rawatan dan kebersihan

- ▶ **Perkakas listrik dan lubang ventilasi harus selalu dibersihkan supaya perkakas bisa digunakan dengan baik dan aman.**

Pada penggunaan yang luar biasa, jika mungkin gunakanlah selalu sarana penghisapan. Lubang ventilasi harus sering dibersihkan dengan cara meniup dan gunakanlah sakelar pengaman terhadap arus penyimpangan (FI). Jika mengerjakan bahan logam bisa terjadi debu yang konduktif di dalam perkakas listrik. Isolasi keselamatan dari perkakas listrik bisa menjadi berkurang. Simpanlah dan tangani aksesoris secara cermat.

Jika kabel listrik harus digantikan, pekerjaan ini harus dilakukan oleh Bosch atau Service Center untuk perkakas listrik Bosch yang resmi, supaya keselamatan kerja selalu terjamin.

Layanan pasca beli dan konseling terkait pengoperasian

Layanan pasca beli Bosch menjawab semua pertanyaan Anda terkait reparasi dan maintenance serta suku cadang produk ini. Gambar tiga dimensi dan informasi terkait suku cadang dapat Anda lihat di:

www.bosch-pt.com

Tim konseling pengoperasian dari Bosch dengan senang hati membantu Anda, jika Anda hendak bertanya tentang produk-produk kami dan aksesorisnya.

Jika Anda hendak menanyakan sesuatu atau memesan suku cadang, sebutkan selalu nomor model yang terdiri dari 10 angka dan tercantum pada label tipe perkakas.

Indonesia

PT Robert Bosch
Palma Tower 9th & 10th Floor
Jl. Let. Jend. TB Simatupang II S/06
Jakarta Selatan 12960
Indonesia
Tel.: (021) 3005 6565
Fax: (021) 3005 5801
E-Mail: boschpowertools@id.bosch.com
www.bosch-pt.co.id

Cara membuang

Perkakas listrik, aksesoris dan kemasan sebaiknya didaur ulangkan sesuai dengan upaya untuk melindungi lingkungan hidup.

Janganlah membuang perkakas listrik dalam sampah rumah tangga!

Perubahan dapat terjadi tanpa pemberitahuan sebelumnya.

Tiếng Việt**Cảnh báo tổng quát cách sử dụng an toàn dụng cụ điện cầm tay**

⚠ CẢNH BÁO Đọc kỹ mọi cảnh báo an toàn và hướng dẫn. Không tuân thủ mọi cảnh báo và hướng dẫn được liệt kê dưới đây có thể bị điện giật, gây cháy và/hay bị thương tật nghiêm trọng.

Hãy giữ tất cả tài liệu về cảnh báo và hướng dẫn để tham khảo về sau.

Thuật ngữ “dụng cụ điện cầm tay” trong phần cảnh báo là để cập đến sự sử dụng dụng cụ điện cầm tay của bạn, loại sử dụng điện nguồn (có dây cắm điện) hay vận hành bằng pin (không dây cắm điện).

Khu vực làm việc an toàn

- ▶ **Giữ nơi làm việc sạch và đủ ánh sáng.** Nơi làm việc bừa bộn và tối tăm dễ gây ra tai nạn.
- ▶ **Không vận hành dụng cụ điện cầm tay trong môi trường dễ gây nổ, chẳng hạn như nơi có chất lỏng dễ cháy, khí đốt hay rác.** Dụng cụ điện cầm tay tạo ra các tia lửa nên có thể làm rác bén cháy hay bốc khói.
- ▶ **Không để trẻ em hay người đến xem đứng gần khi vận hành dụng cụ điện cầm tay.** Sự phân tâm có thể gây ra sự mất điều khiển.

An toàn về điện

- ▶ **Phích cắm của dụng cụ điện cầm tay phải thích hợp với ổ cắm. Không bao giờ được cài biến lại phích cắm dưới mọi hình thức. Không được sử dụng phích tiếp hợp nối tiếp đất (dây mát).** Phích cắm nguyên bản và ổ cắm đúng loại sẽ làm giảm nguy cơ bị điện giật.
- ▶ **Tránh không để thân thể tiếp xúc với đất hay các vật có bề mặt tiếp đất như đường ống, lò sưởi, hàng rào và tủ lạnh.** Có nhiều nguy cơ bị điện giật hơn nếu cơ thể bạn bị tiếp hay nối đất.
- ▶ **Không được để dụng cụ điện cầm tay ngoài mưa hay ở tình trạng ẩm ướt.** Nước vào máy sẽ làm tăng nguy cơ bị điện giật.

- ▶ **Không được lạm dụng dây dẫn điện.** Không bao giờ được nắm dây dẫn để xách, kéo hay rút phích cắm dụng cụ điện cầm tay. Không để dây gần nơi có nhiệt độ cao, dầu nhớt, vật nhọn bén hay bộ phận chuyển động. Làm hỏng hay cuộn rối dây dẫn làm tăng nguy cơ bị điện giật.
- ▶ **Khi sử dụng dụng cụ điện cầm tay ngoài trời,** dùng dây nối thích hợp cho việc sử dụng ngoài trời làm giảm nguy cơ bị điện giật.
- ▶ **Nếu việc sử dụng dụng cụ điện cầm tay ở nơi ẩm ướt là không thể tránh được,** dùng thiết bị ngắt mạch tự động (RCD) bảo vệ nguồn. Sử dụng thiết bị ngắt mạch tự động RCD làm giảm nguy cơ bị điện giật.

An toàn cá nhân

- ▶ **Hãy tỉnh táo, biết rõ mình đang làm gì và hãy sử dụng ý thức khi vận hành dụng cụ điện cầm tay.** Không sử dụng dụng cụ điện cầm tay khi đang mệt mỏi hay đang bị tác động do chất gây nghiện, rượu hay dược phẩm gây ra. Một thoáng mất tập trung khi đang vận hành dụng cụ điện cầm tay có thể gây thương tích nghiêm trọng cho bản thân.
- ▶ **Sử dụng trang bị bảo hộ cá nhân.** Luôn luôn đeo kính bảo vệ mắt. Trang bị bảo hộ như khẩu trang, giày chống trượt, nón bảo hộ, hay dụng cụ bảo vệ tai khi được sử dụng đúng nơi đúng chỗ sẽ làm giảm nguy cơ thương tật cho bản thân.
- ▶ **Phòng tránh máy khởi động bất ngờ.** Bảo đảm công tắc máy ở vị trí tắt trước khi cắm vào nguồn điện và/hay lắp pin vào, khi nhắc máy lên hay khi mang xách máy. Ngáng ngón tay vào công tắc máy để xách hay kích hoạt dụng cụ điện cầm tay khi công tắc ở vị trí mở dễ dẫn đến tai nạn.
- ▶ **Lấy mọi chìa hay khóa điều chỉnh ra trước khi mở điện dụng cụ điện cầm tay.** Khóa hay chìa còn gắn dính vào bộ phận quay của dụng cụ điện cầm tay có thể gây thương tích cho bản thân.
- ▶ **Không rướn người.** Luôn luôn giữ tư thế đứng thích hợp và thăng bằng. Điều này tạo cho việc điều khiển dụng cụ điện cầm tay tốt hơn trong mọi tình huống bất ngờ.
- ▶ **Trang phục thích hợp.** Không mặc quần áo rộng lủng thụng hay mang trang sức. Giữ tóc, quần áo và găng tay xa khỏi các bộ phận chuyển động. Quần áo rộng lủng thụng, đồ trang sức hay tóc dài có thể bị cuốn vào các bộ phận chuyển động.

- ▶ **Nếu có các thiết bị đi kèm để nối máy hút bụi và các phụ kiện khác,** bảo đảm các thiết bị này được nối và sử dụng tốt. Việc sử dụng các thiết bị gom hút bụi có thể làm giảm các độc hại liên quan đến bụi gây ra.

Sử dụng và bảo dưỡng dụng cụ điện cầm tay

- ▶ **Không được ép máy.** Sử dụng dụng cụ điện cầm tay đúng loại theo đúng ứng dụng của bạn. Dụng cụ điện cầm tay đúng chức năng sẽ làm việc tốt và an toàn hơn theo đúng tiến độ mà máy được thiết kế.
- ▶ **Không sử dụng dụng cụ điện cầm tay nếu như công tắc không tắt và mở được.** Bất kỳ dụng cụ điện cầm tay nào mà không thể điều khiển được bằng công tắc là nguy hiểm và phải được sửa chữa.
- ▶ **Rút phích cắm ra khỏi nguồn điện và/hay pin ra khỏi dụng cụ điện cầm tay trước khi tiến hành bất kỳ điều chỉnh nào, thay phụ kiện, hay cắt dụng cụ điện cầm tay.** Các biện pháp ngăn ngừa như vậy làm giảm nguy cơ dụng cụ điện cầm tay khởi động bất ngờ.
- ▶ **Cất giữ dụng cụ điện cầm tay không dùng tới nơi trẻ em không lấy được và không cho người chưa từng biết dụng cụ điện cầm tay hay các hướng dẫn này sử dụng dụng cụ điện cầm tay.** Dụng cụ điện cầm tay nguy hiểm khi ở trong tay người chưa được chỉ cách sử dụng.
- ▶ **Bảo quản dụng cụ điện cầm tay.** Kiểm tra xem các bộ phận chuyển động có bị sai lệch hay kẹt, các bộ phận bị rạn nứt và các tình trạng khác có thể ảnh hưởng đến sự vận hành của máy. Nếu bị hư hỏng, phải sửa chữa máy trước khi sử dụng. Nhiều tai nạn xảy ra do bảo quản dụng cụ điện cầm tay tồi.
- ▶ **Giữ các dụng cụ cất bên và sạch.** Bảo quản đúng cách các dụng cụ cất có cạnh cắt bén làm giảm khả năng bị kẹt và dễ điều khiển hơn.
- ▶ **Sử dụng dụng cụ điện cầm tay, phụ kiện, đầu cài v. v., đúng theo các chỉ dẫn này, hãy lưu ý đến điều kiện làm việc và công việc phải thực hiện.** Sử dụng dụng cụ điện cầm tay khác với mục đích thiết kế có thể tạo nên tình huống nguy hiểm.

Bảo dưỡng

- ▶ **Đưa dụng cụ điện cầm tay của bạn đến thợ chuyên môn để bảo dưỡng, chỉ sử dụng phụ tùng đúng chủng loại để thay.** Điều này sẽ đảm bảo sự an toàn của máy được giữ nguyên.

Cảnh Báo An Toàn cho Máy Mài Hình Góc

Các cảnh báo an toàn dùng chung cho các hoạt động mài, chà nhám, chà bằng bàn chải kim loại hay cắt bằng đá cắt

- ▶ **Dụng cụ điện cầm tay này được thiết kế để thể hiện chức năng như một máy mài, máy chà nhám, bàn chải kim loại hay máy cắt. Xin hãy đọc tất cả các cảnh báo an toàn, chỉ dẫn, hình ảnh minh họa và các đặc tính kỹ thuật được cung cấp kèm theo dụng cụ điện cầm tay này.** Không tuân thủ các hướng dẫn được liệt kê dưới đây có thể dẫn đến việc bị điện giật, gây cháy/hoặc bị thương tích nghiêm trọng.
- ▶ **Dụng cụ điện cầm tay này không nên sử dụng để đánh bóng.** Vận hành theo cách mà dụng cụ điện cầm tay không được thiết kế để sử dụng có thể dẫn đến việc gặp nguy hiểm và gây thương tích cho bản thân.
- ▶ **Không sử dụng loại phụ tùng không được thiết kế chuyên dụng và đã được nhà sản xuất máy khuyến cáo.** Chỉ vì phụ tùng có thể lắp vào được dụng cụ điện của bạn, nó không đảm bảo sự vận hành an toàn.
- ▶ **Tốc độ danh định của phụ tùng phải ít nhất là bằng với tốc độ tối đa được ghi trên dụng cụ điện cầm tay.** Phụ tùng chạy nhanh hơn tốc độ danh định của chúng có thể văng vỡ ra.
- ▶ **Đường kính ngoài và độ dày phụ tùng của bạn phải nằm trong công suất danh định của dụng cụ điện của bạn.** Không thể bảo vệ hay điều khiển đúng cách được với phụ tùng không đúng kích cỡ.
- ▶ **Đường ren của phụ kiện gắn vào phải tương xứng với đường ren của trục máy mài. Đối với các phụ kiện bắt vào bằng bích, lỗ tâm của phụ kiện phải vừa khít với đường kính định vị của bích.** Phụ kiện không thích hợp với vòng cỡ lắp của dụng cụ điện sẽ chạy mất thăng bằng, rung dữ dội và có thể gây nên sự mất kiểm soát.
- ▶ **Không được sử dụng phụ tùng đã bị hư hỏng.** Trước mỗi lần sử dụng, kiểm tra phụ tùng giả dụ như là đĩa hạt mài xem có bị nứt mẻ hay rạn nứt, miếng đệm xem có bị rách hay quá mòn, bàn chải kim loại xem râu có bị gãy hay dính không chặt. Nếu dụng cụ điện hay phụ tùng bị rơi xuống, kiểm tra xem có hư hỏng hay lắp phụ tùng còn tốt nguyên vào. Sau khi kiểm tra và lắp phụ tùng vào, bố trí bản thân bạn và những người gần đó ra xa khỏi các điểm tiếp cận được của phụ tùng đang quay và cho

dụng cụ điện của bạn chạy với tốc độ không tải tối đa trong một phút. Phụ tùng bị hỏng thường thì sẽ bị văng vỡ ra trong thời điểm kiểm tra này.

- ▶ **Hãy mang trang bị bảo hộ vào.** Tùy theo loại công việc, sử dụng chần che mặt, kính chụp mắt hay kính bảo hộ. Để thích hợp, mang mặt nạ chống bụi, đồ dùng bảo hộ tai nghe, găng tay và quần áo bảo hộ có khả năng ngăn bụi đá hay các mảnh vỡ của vật gia công bắn vào. Sự bảo vệ mắt là phải có khả năng ngăn được các mảnh vỡ văng ra từ các ứng dụng khác nhau tạo nên. Mặt nạ chống bụi hay khẩu trang phải có khả năng lọc được các hạt nhỏ phát sinh ra từ chính các hoạt động máy của bạn. Kéo dài thời gian để tai trần tiếp xúc với tiếng ồn có cường độ mạnh có thể gây điếc.
- ▶ **Bố trí những người đứng xem ở khoảng cách an toàn ra xa khỏi nơi làm việc. Những ai đi vào khu vực làm việc phải có trang bị bảo hộ cá nhân.** Mảnh vỡ của vật gia công hay của phụ tùng có khả năng văng ra và gây thương tích bên ngoài khu vực vận hành máy.
- ▶ **Chỉ nắm giữ dụng cụ điện ở phần nắm đã được cách điện, khi vận hành máy ở nơi mà dụng cụ cắt có thể chạm phải dây điện được thiết kế dấu không nhìn thấy được hay chính dây dẫn của máy.** Dụng cụ cắt chạm phải dây "có điện" có thể làm cho các bộ phận kim loại không được bao bọc "có điện" và giật người vận hành máy.
- ▶ **Để dây điện tránh xa phụ tùng đang quay.** Nếu sự kiểm soát dụng cụ điện bị mất, dây điện có thể bị cắt, tay hay cánh tay của bạn có thể bị quấn lại và bị lôi vào phụ tùng đang quay.
- ▶ **Không bao giờ được đặt dụng cụ điện xuống cho đến khi phụ tùng đã ngừng quay hoàn toàn.** Phụ tùng đang quay có thể ăn vào vào bề mặt vật liệu và kéo dụng cụ điện ra khỏi sự điều khiển của bạn.
- ▶ **Không cho dụng cụ điện hoạt động khi đang mang bên hông.** Vô tình chạm vào phụ tùng đang quay, quần áo bạn có thể bị quấn vào, kéo phụ tùng xía vào mình bạn.
- ▶ **Thường xuyên làm sạch các khe thông gió của dụng cụ điện.** Quạt gió mô tơ sẽ kéo bụi nằm trong vỏ máy ra và sự tích tụ quá nhiều bột kim loại có thể gây nên các nguy hiểm về điện.
- ▶ **Không được vận hành dụng cụ điện gần nơi có các chất dễ cháy.** Tia lửa bắn ra có thể gây cháy các nguyên liệu này.
- ▶ **Không sử dụng phụ tùng loại cần có chất lỏng làm mát.** Sử dụng nước hay các loại chất lỏng làm

mắt khác có thể dẫn đến việc chết do điện giật hay bị điện giật.

Lực dội ngược và các cảnh báo liên quan

- ▶ Dội ngược là một phản ứng đột ngột do đĩa đang quay, miếng đệm, chốt chà hay bất cứ phụ tùng nào khác bị kẹt lại hay gặp trở ngại bất ngờ. Sự cố bị kẹt lại hay gặp trở ngại bất ngờ làm cho phụ tùng đang quay nhanh chóng ngừng ngay hoạt động, hậu quả là làm cho dụng cụ điện cầm tay bị mất điều khiển nên quay ngược lại chiều quay của phụ tùng ngay thời điểm bị kẹt chặt. Ví dụ, nếu một đĩa hạt mài bị vật gia công chèn chặt hay bị kẹt lại, cạnh của đĩa đang tiến vào điểm bị kẹt có thể bập lên bề mặt của vật liệu làm cho đĩa leo ra hay bật ngược lại. Đĩa có thể nhảy chồm về phía trước hay văng ra khỏi người điều khiển máy, tùy theo hướng chuyển động của đĩa ngay thời điểm bị kẹt. Trong trường hợp này, các đĩa dạng hạt có khả năng bị vỡ. Sự dội ngược là hậu quả của việc sử dụng dụng cụ điện cầm tay không đúng chức năng và/hay qui trình thao tác không đúng cách hoặc do điều kiện xấu và có thể tránh được bằng cách tuân theo các cách phòng tránh thích hợp được trình bày dưới đây.
- ▶ **Luôn giữ chắc dụng cụ điện và tạo tư thế thân thể và cánh tay cho phép bạn chịu được lực dội ngược. Luôn luôn sử dụng tay nắm phụ, nếu có kèm theo máy, để khống chế tối đa các phản ứng dội ngược hay vận xoắn trong thời điểm khởi động.** Người vận hành máy có thể kiểm soát được các phản ứng vận xoắn hay lực dội ngược nếu tuân thủ các chỉ dẫn phòng tránh đúng cách.
- ▶ **Không bao giờ được để tay của bạn gần phụ tùng đang quay.** Phụ tùng có thể động ngược lên tay của bạn.
- ▶ **Không để người của bạn phò ra trong phạm vi mà dụng cụ điện sẽ tới được nếu sự dội ngược xảy ra.** Sự dội ngược sẽ làm quay dụng cụ điện về chiều ngược với chiều chuyển động của đĩa tại thời điểm gặp sự cố.
- ▶ **Hãy đặt biệt lưu ý khi gia công các góc cạnh, cạnh bén v.v. Tránh không để phụ tùng bị nảy lên hay bị chèn chặt.** Các góc, cạnh bén hay sự nảy lên có khuynh hướng làm cho phụ tùng đang quay bị trở ngại và làm mất điều khiển hay bị dội ngược.
- ▶ **Không lắp lưới cửa xích, dao khắc gỗ hay lưới cửa răng vào.** Những loại lưới như vậy thường xuyên tạo ra sự dội ngược và làm mất sự điều khiển dụng cụ điện.

Các hướng dẫn an toàn bổ sung thêm dành cho các hoạt động mài và cắt

- ▶ **Chỉ sử dụng loại đĩa được khuyến cáo dùng cho dụng cụ điện của bạn và chấn bảo vệ được thiết kế dành riêng cho loại đĩa được chọn.** Các đĩa không được thiết kế cho dụng cụ điện cầm tay không thể bảo vệ ta đúng cách và không an toàn.
- ▶ **Bề mặt mài của đĩa có tâm đĩa được nén phải được lắp bên dưới mặt phẳng của cạnh chấn bảo vệ.** Một đĩa được lắp không đúng cách như nhô ra khỏi mặt phẳng của cạnh chấn bảo vệ, không thể bảo vệ thích đáng được.
- ▶ **Chấn bảo vệ phải được gắn chắc chắn vào dụng cụ điện và đặt ở tư thế có độ an toàn tối đa, như thế, phần phò ra của đĩa hướng về người vận hành máy là nhỏ nhất.** Chấn bảo vệ giúp bảo vệ người vận hành máy tránh khỏi các mảnh vỡ của đĩa, sự vô tình chạm phải đĩa và các tia lửa bắn ra có thể gây cháy quần áo.
- ▶ **Chỉ được sử dụng đĩa theo đúng khuyến cáo ứng dụng. Ví dụ: không được lấy cạnh của đĩa cắt để mài.** Đĩa cắt dạng hạt được cấu tạo dùng chu vi ngoại biên đĩa để mài; Lực đẩy ngang áp vào các đĩa này có thể làm chúng vỡ vụn ra.
- ▶ **Luôn sử dụng bích lắp còn tốt nguyên, đúng kích cỡ và hình dáng cho loại đĩa mà bạn chọn.** Bích lắp đúng chủng loại chống đỡ cho đĩa, do đó làm giảm khả năng vỡ đĩa. Bích lắp dùng cho đĩa cắt có thể khác với bích lắp dùng cho đĩa mài.
- ▶ **Không sử dụng đĩa dùng cho dụng cụ điện lớn hơn đã bị mòn nhỏ lại.** Đĩa được cấu tạo cho dụng cụ điện loại lớn không thích hợp với dụng cụ điện cầm tay nhỏ lại có tốc độ cao hơn và có thể bị vỡ tung.

Các cảnh báo an toàn cụ thể phụ thêm dành cho các hoạt động cắt bằng chất liệu hạt mài

- ▶ **Không được làm đĩa cắt “bị kẹt” hay dùng sức ép thái quá để đè máy. Không cố cắt sâu quá mức.** Tạo lực áp quá đáng lên đĩa làm tăng sức tải và dễ làm đĩa bị xoắn vận hay bị kèn chặt trong đường cắt và có khả năng dội ngược hay vỡ đĩa xảy ra.
- ▶ **Không để thân thể bạn ở vị trí cùng hàng hay là nằm sau đĩa đang quay.** Ngay thời điểm vận động, khi đĩa đang di chuyển từ chỗ bạn ra ngoài, khả năng bị dội ngược có thể xoay ngược cái đĩa đang quay tới trước và dụng cụ điện hướng thẳng đến người bạn.

50 | Tiếng Việt

- ▶ **Khi đĩa bị kẹt hay động tác cắt bị gián đoạn do bất kỳ lý do gì, tắt ngay dụng cụ điện và giữ nguyên dụng cụ điện cho đến khi đĩa ngừng quay hoàn toàn. Không bao giờ cố nhấc đĩa cắt ra khỏi mạch cắt khi đĩa còn đang chuyển động, nếu không thì sự giựt ngược có thể xảy ra.** Kiểm tra và có các hành động thích hợp để loại trừ nguyên nhân gây ra kẹt đĩa.
- ▶ **Không được mở máy lại để cắt khi đĩa còn nằm trong vật gia công. Hãy để cho đĩa chạy hết công suất và cẩn thận đưa vào mạch cắt lại.** Đĩa có thể bị kẹt, leo lên trên hay giựt ngược nếu dụng cụ điện được khởi động lại khi còn ở trong vật gia công.
- ▶ **Kê đỡ các tấm ván hay bất cứ vật gia công quá khổ nào để làm giảm thiểu thấp nhất nguy cơ làm đĩa bị kẹt hay bị dội ngược.** Các vật liệu gia công lớn có khuynh hướng vòng xuống do chính trọng lượng của chúng. Các vật kê đỡ phải được đặt dưới vật gia công, gần mạch cắt và gần rìa của vật gia công ở hai bên đĩa.
- ▶ **Hãy cẩn trọng hơn khi thực hiện việc “cắt mò” vào các bức tường có sẵn hay các khu vực không nhìn thấy được.** Phần nhô ra của đĩa có thể cắt phạm vào ống dẫn khí đốt hay nước, đường điện hay các vật thể khác, sự cố này có thể gây ra sự dội ngược.

Các cảnh báo an toàn cụ thể dành cho các hoạt động chà nhám

- ▶ **Khi chà nhám, không được dùng giấy nhám đĩa lớn quá cỡ. Tuân thủ theo khuyến cáo của nhà sản xuất khi chọn giấy nhám.** Giấy nhám lớn hơn phủ tràn ra ngoài miếng lót chà nhám bộc lộ nguy cơ bị xé toạc và có thể gây sự cố bất ngờ, làm rách đĩa, hay dội ngược.

Các cảnh báo an toàn cụ thể dành cho các hoạt động đánh ráp bằng bàn chải kim loại

- ▶ **Cần nhận biết rằng râu chổi bị bàn chải đẩy văng ra ngay cả khi thao tác thông thường. Đừng dè ép râu bàn chải mạnh quá do bất bàn chải chịu lực tải quá mức.** Râu kim loại có thể dễ dàng đâm thủng quần áo mỏng và/hay da.
- ▶ **Nếu như việc sử dụng chấn bảo vệ được khuyến cáo dùng cho việc đánh ráp bằng bàn chải kim loại, không được để cho râu kim loại của đĩa hay bàn chải kim loại chạm vào chấn bảo vệ.** Bàn chải đĩa hay bàn chải kim loại có thể nở rộng đường kính ra do chịu lực tải và lực ly tâm.

Các Hướng Dẫn An Toàn và Vận Hành Bổ Sung

- ▶ **Tuân thủ theo đúng điện thế!** Điện thế nguồn chính phải đúng với các dữ liệu được ghi trên nhãn máy.
- ▶ **Dùng thiết bị dò tìm thích hợp để xác định nếu có các công trình công cộng lắp đặt ngầm trong khu vực làm việc hay liên hệ với Cty công trình Công cộng địa phương để nhờ hỗ trợ.** Dụng cụ chạm đường dẫn điện có thể gây ra hỏa hoạn và điện giựt. Làm hư hại đường dẫn khí ga có thể gây nổ. Làm thủng đường dẫn nước gây hư hỏng tài sản hay có khả năng gây ra điện giựt.
- ▶ **Nhà công tác Tắt/Mở ra và chuyển về vị trí tắt khi nguồn điện cung cấp bị ngắt, ví dụ., như khi bị mất điện hay khi phích cắm bị tuột ra.** Cách này để ngăn sự khởi động lại không được kiểm soát.
- ▶ **Bụi từ các vật liệu như là lớp phủ có chứa chì, một số loại gỗ, khoáng chất và kim loại có thể gây nguy hại đến sức khỏe và gây dị ứng, dẫn đến sự nhiễm trùng đường hô hấp và/hay gây ung thư.** Vật liệu chứa amiăng có thể chỉ nên để cho các thợ chuyên môn gia công.
 - Cách xa ở mức có thể được, sử dụng hệ thống hút thích hợp cho loại vật liệu.
 - Tạo không khí thông thoáng nơi làm việc.
 - Khuyến nghị nên mang mặt nạ phòng độc có bộ lọc cấp P2.
 Tuân thủ các qui định của quốc gia bạn liên quan đến loại vật liệu gia công.
- ▶ **Tránh không để rác tích tụ tại nơi làm việc.** Rác có thể dễ dàng bắt lửa.
- ▶ **Kẹp chặt vật gia công.** Vật gia công được kẹp bằng một thiết bị kẹp hay bằng étô thì vững chắc hơn giữ bằng tay.
- ▶ Trong quá trình vận hành mà sau đó đĩa bị vỡ hay các chi tiết dùng lắp ráp nằm trên chấn bảo vệ/dụng cụ điện bị hỏng, máy phải được mang đến ngay đại lý phục vụ hàng sau khi bán để bảo trì, sửa chữa (để biết địa chỉ liên hệ, xin xem Phần “Dịch Vụ Sau Khi Bán và Dịch Vụ Ứng Dụng”).
- ▶ **Điều chỉnh chấn bảo vệ cách sao cho các tia lửa bắn ra không hướng vào người vận hành máy.**
- ▶ **Chỉ có thể được xoay chấn bảo vệ trong khi kích hoạt đòn nhả trên ụ trước trục chính. Nếu không như thế, máy có thể không thể tiếp tục sử dụng được nữa và phải gửi máy đến một đại lý phục vụ hàng sau khi bán để sửa chữa.**

- ▶ **Không được chạm vào đĩa mài hay đĩa cắt trước khi các đĩa này đã nguội.** Đĩa có thể trở nên rất nóng trong lúc hoạt động.
- ▶ **Chỉ cho nút khóa trục hoạt động khi trục máy mài đã đứng yên.** Nếu không, máy có thể bị làm hỏng.
- ▶ **Sau khi lắp dụng cụ mài và trước khi mở máy, kiểm tra xem dụng cụ mài có lắp vào đúng cách không và có thể quay tự do không. Đảm bảo dụng cụ mài không chạm vào chắn bảo vệ hay các bộ phận khác.**
- ▶ **Khi vận hành máy bằng nguồn điện từ máy phát điện di động, sự không đạt được hiệu suất hay các biểu hiện bất thường có thể xảy ra ngay khi mở máy.**
- ▶ **Sử dụng lực áp quá mạnh làm máy có thể bị chịu quá tải. Sự quá tải có thể dẫn đến việc làm cho dụng cụ điện bị quá nóng và làm hư hỏng dụng cụ điện. Sau thời gian dụng cụ điện hoạt động ở cao độ, tiếp tục cho máy chạy không tải vài phút để làm nguội máy.**
- ▶ **Không được sử dụng dụng cụ điện cùng chung với giá cắt.**
- ▶ **Không bao giờ được sử dụng đĩa cắt để chà thô.**
- ▶ **Đai ốc chặn thay nhanh có thể chỉ được sử dụng cho đĩa mài hay cắt. Chỉ sử dụng đai ốc chặn thay nhanh còn tốt, nguyên vẹn.**
- ▶ **Không được kéo ụ trước trục chính ra trong khi xoay – xem hình 12, trang 70.**

Các Biểu Tượng

Các biểu tượng sau đây mang ý nghĩa quan trọng để suy diễn và hiểu các hướng dẫn sử dụng. Xin vui lòng lưu ý đến các biểu tượng và ý nghĩa của chúng. Sự hiểu đúng các biểu tượng sẽ giúp bạn sử dụng máy một cách tốt và an toàn hơn.

Biểu Tượng	Ý Nghĩa
	Mã số máy
	Đọc tất cả các cảnh báo an toàn và mọi hướng dẫn
	Trước khi thực hiện bất cứ việc gì trên máy, rút phích cắm ra khỏi ổ điện nguồn

Biểu Tượng	Ý Nghĩa
	Hãy mang găng tay bảo vệ
	Mang dụng cụ bảo vệ tai
	Mang kính an toàn/kính bảo hộ lao động
	Chiều chuyển động
	Dụng sức cho công đoạn làm việc.
	Tốc độ thấp
	Tốc độ cao
	Mở công tắc
	Để tắt máy
	Công tắc Tắt/Mở được khóa tự-chạy
	Nhà chế độ chức năng tự chạy của công tắc Tắt/Mở
	Hành động bị cấm
	Hành động được phép
	Bước hành động kế tiếp
P_1	Công suất vào danh định
P_2	Công suất ra
n	Tốc độ danh định
n_v	Điều chỉnh phần kiểm soát tốc độ
d_1	l = Chiều dài trục máy mài d_1 = Đường kính trục máy mài
d_2	D = Đường kính tối đa của đĩa mài d_2 = Đường kính trong của đĩa
	Chọn Trước Tốc Độ

52 | Tiếng Việt

Biểu Tượng	Ý Nghĩa
	Kiểm Soát Sự Ổn Định Điện Tử
	Chống dội ngược
	Chống sự khởi động lại
	Làm giảm cường độ dòng điện khi khởi động
	Các thông tin bổ sung
	Mài bề mặt
	Mài/Chà ráp bằng giấy nhám
	Trọng lượng có tay nắm phụ giảm chấn dựa theo Quy Trình EPTA 01:2014
	Trọng lượng có tay nắm phụ tiêu chuẩn dựa theo Quy Trình EPTA 01:2014
	Biểu tượng của cấp độ bảo vệ II (hoàn toàn cách điện)

Các món được giao

Máy mài góc, chắn bảo vệ, tay nắm phụ.
Chắn bảo vệ đặc biệt, dụng cụ ứng dụng và các phụ kiện khác được trình bày hay mô tả không phải là một phần trong tiêu chuẩn hàng được giao.
Bạn có thể tìm thấy thông tin mô tả tổng quát các phụ kiện trong chương trình phụ kiện của chúng tôi.

Dành sử dụng cho

Máy được thiết kế để chà thô kim loại, đá và vật liệu gốm và dùng khoan ngói hay đá lát.
Để cắt bằng vật liệu mài nén kết, cần phải sử dụng dũa cắt đặc biệt (phụ kiện).
Khi cắt đá, phải đáp ứng đầy đủ khả năng hút bụi.
Cùng với chắn bảo vệ tay (phụ kiện), máy có thể sử dụng để chải và mài/chà bằng đĩa chà mịn và dẻo.
Máy chỉ thích hợp để hoạt động không sử dụng nước.











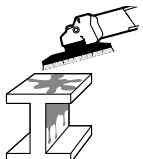

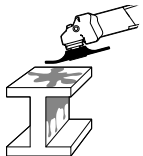

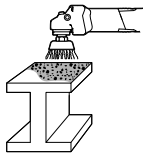

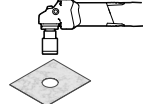

Thông số kỹ thuật

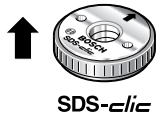
Tính năng kỹ thuật của máy được liệt kê trong Bảng ở trang 55 - 56 của các hướng dẫn sử dụng này.
Các giá trị đã cho có hiệu lực cho điện thế danh định [U] 230 V. Đối với điện thế thấp hơn và các loại máy dành riêng cho một số quốc gia, các giá trị này có thể thay đổi.
Xin vui lòng xem kỹ mã số máy trên nhãn máy của bạn. Tên thương mại của từng máy có thể khác nhau.

Lắp và Vận Hành

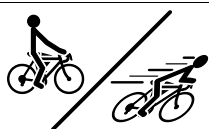
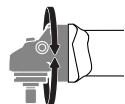
Biểu bảng sau đây chỉ rõ các thao tác cho mục đích lắp ráp và vận hành dụng cụ điện. Sự hướng dẫn cho từng thao tác mục đích được trình bày bên cạnh. Tùy theo loại hình ứng dụng, sự kết hợp một số hướng dẫn là cần thiết. Tuân thủ các hướng dẫn cho sự an toàn.

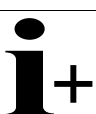
Loại công việc	Hình ảnh	Xin vui lòng tuân thủ	Trang
Mài, sự chuẩn bị			57 – 58
Cắt, sự chuẩn bị			59 – 60
Cắt đá, gạch ngói hay đá lát, sự chuẩn bị (khuyến nghị)			61 – 62

Loại công việc	Hình ảnh	Xin vui lòng tuân thủ	Trang
Chà nhám với chụp hút, sự chuẩn bị			63–64
Chà cạo sơn, sự chuẩn bị			65
Chà gỉ sét, sự chuẩn bị			66
Khoan ngói hay đá lát, sự chuẩn bị			67
Lắp đai ốc chặn thay nhanh	 SDS- <i>clíc</i>		67–68
Tháo đai ốc chặn thay nhanh	 SDS- <i>clíc</i>		68
Mở và Tắt			68
Điều chỉnh sự chính đặt trước tốc độ			69
Xoay Đầu Máy			70
Làm việc hiệu quả với máy mài góc			71

54 | Tiếng Việt

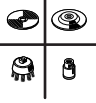
Loại công việc	Hình ảnh	Xin vui lòng tuân thủ	Trang
Phạm vi có màu xám: Tay nắm (phần nắm được cách điện)		14	71
Chọn dụng cụ mài có thể chấp nhận được		15	72
Chọn phụ tùng	–	–	73 – 75

Bảo Dưỡng Và Làm Sạch

► **Để được an toàn và máy hoạt động đúng chức năng, luôn luôn giữ máy và các khe thông gió được sạch.**

Trong điều kiện giới hạn tuyệt đối, luôn luôn sử dụng máy hút bụi trong khả năng có thể. Thổi sạch các khe thông gió thường xuyên và lắp đặt thiết bị ngắt mạch tự động (RCD). Khi gia công kim loại, các loại hạt bụi dẫn điện có thể lọt vào trong dụng cụ điện. Toàn bộ sự cách điện của dụng cụ điện có thể bị mất tác dụng.

Xin vui lòng bảo quản và giữ gìn tay nắm và phụ tùng cẩn thận.

Nếu như cần phải thay dây dẫn điện thì công việc này phải do hãng Bosch, hay một đại lý được Bosch ủy nhiệm thực hiện để tránh gặp sự nguy hiểm do mất an toàn.

Dịch Vụ Sau Khi Bán và Dịch Vụ Ứng Dụng

Bộ phận phục vụ hàng sau khi bán của chúng tôi sẽ trả lời các câu hỏi liên quan đến việc bảo trì và sửa chữa các sản phẩm cũng như các phụ tùng thay thế của bạn. Hình ảnh chi tiết và thông tin phụ tùng thay thế có thể tìm hiểu theo địa chỉ dưới đây:

www.bosch-pt.com

Bộ phận dịch vụ ứng dụng Bosch sẽ hân hạnh trả lời các câu hỏi liên quan đến các sản phẩm của chúng tôi và linh kiện của chúng.

Trong mọi thư từ giao dịch và đơn đặt hàng phụ tùng, xin vui lòng luôn viết đủ 10 con số đã được ghi trên nhãn máy.

Việt Nam









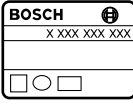

Công ty Trách Nhiệm Hữu Hạn Robert Bosch Việt Nam, PT/SVN
Tầng 10, 194 Golden Building
473 Điện Biên Phủ
Phường 25, Quận Bình Thạnh
Thành Phố Hồ Chí Minh
Việt Nam
Tel.: (08) 6258 3690 Ext 413
Fax: (08) 6258 3692
hieu.lagia@vn.bosch.com
www.bosch-pt.com

Thải bỏ











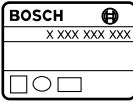
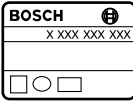





Máy, linh kiện và bao bì phải được phân loại để tái chế theo hướng thân thiện với môi trường.

Không được thải bỏ dụng cụ điện vào chung với rác sinh hoạt!

Được quyền thay đổi nội dung mà không phải thông báo trước.

	GWS ...	9-115	9-125	11-125	12-125 CI	12-125 CI	13-125 CI	13-125 CIE
	3 601 ...	G90 0..	G91 0..	G92 0..	G93 06.	G93 0G.	G9E 0..	G9F 0..
P_1	W	900	900	1100	1150	1200	1300	1300
P_2	W	530	530	740	530	640	700	700
n	min^{-1}	11500	11500	11500	11500	11500	11500	11500
n_v	min^{-1}	-	-	-	-	-	-	2800 - 11500
d_1	l	mm	22	22	22	22	22	22
	d_1		M 14	M 14	M 14	M 14	M 14	M 14
d_2	D	mm	115	125	125	125	125	125
	d_2	mm	22,2	22,2	22,2	22,2	22,2	22,2
	m_1	kg	2,1	2,1	2,3	2,3	2,3	2,3
	m_2	kg	2,0	2,0	2,2	2,2	2,2	2,2
	ELECTRONIC		-	-	-	-	-	•
	CONSTANT ELECTRONIC		-	-	-	•	•	•
	KICK BACK STOP		-	-	-	•	•	•
			-	-	-	•	•	•
			-	-	-	•	•	•

56 |

	GWS ...	15-125 CIE	15-125 Inox	17-125 CI	17-125 CIE	17-125 CIT	17-150 CI	17-125 Inox	
	3 601 ...	G96 0..	G9X 0..	G9G 0..	G9H 0..	G9J 0..	G9K 0..	G9M 0..	
	X XXX XXX XXX								
	P ₁	W	1500	1500	1700	1700	1700	1700	
	P ₂	W	820	820	1010	1010	1010	1010	
	n	min ⁻¹	11500	7500	11500	11500	9300	7500	
	n _v	min ⁻¹	2800 – 11500	2200 – 7500	–	2800 – 11500	2800 – 9300	2200 – 7500	
	d ₁	l	mm	22	22	22	22	22	
	d ₁			M 14	M 14	M 14	M 14	M 14	
	D	mm	125	125	125	125	150	125	
	d ₂	mm	22,2	22,2	22,2	22,2	22,2	22,2	
	m ₁	kg	2,4	2,4	2,4	2,4	2,5	2,4	
	m ₂	kg	2,3	2,3	2,3	2,3	2,4	2,3	
	ELECTRONIC		•	•	–	•	•	–	•
	CONSTANT ELECTRONIC		•	•	•	•	•	•	•
	KICK BACK STOP		•	•	•	•	•	•	•
			•	•	•	•	•	•	•
			•	•	•	•	•	•	•

1

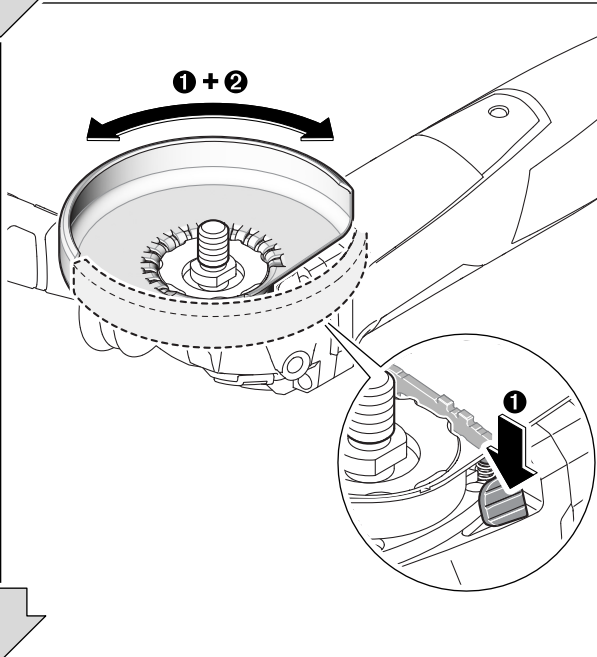
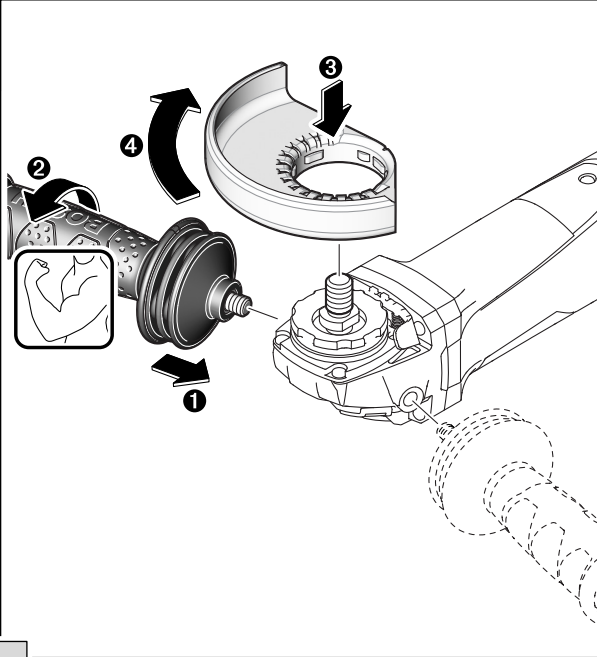
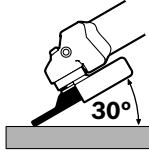

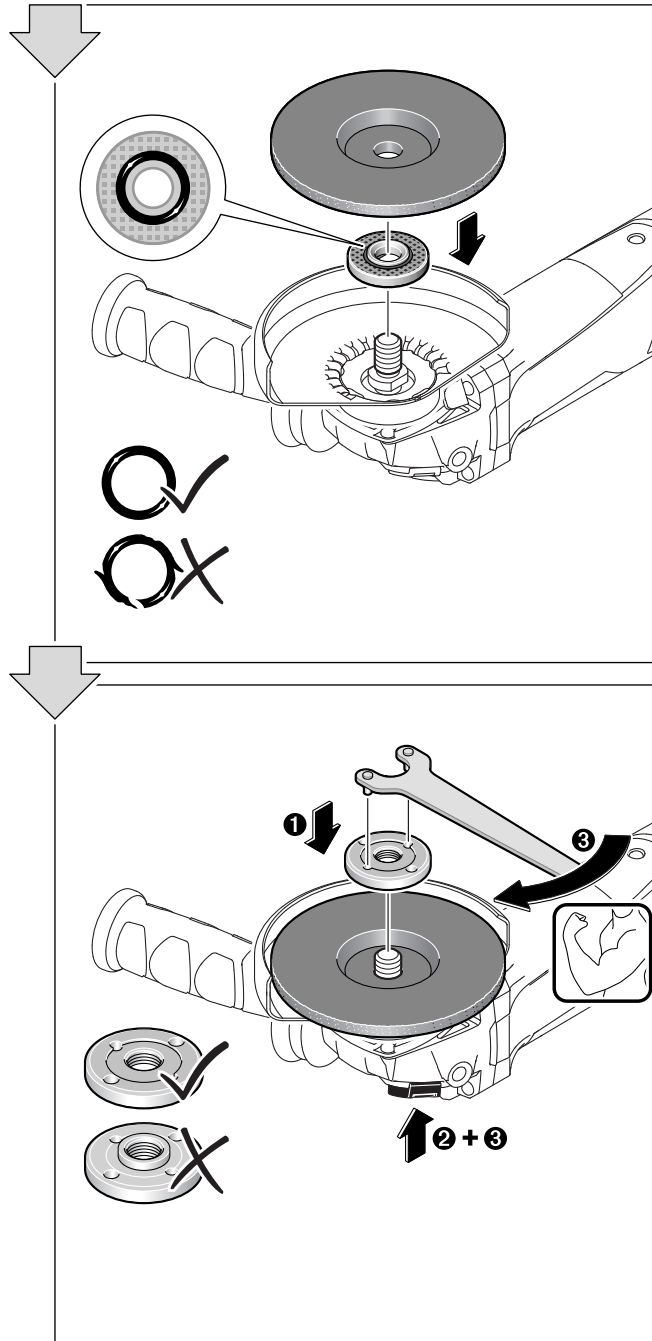

2

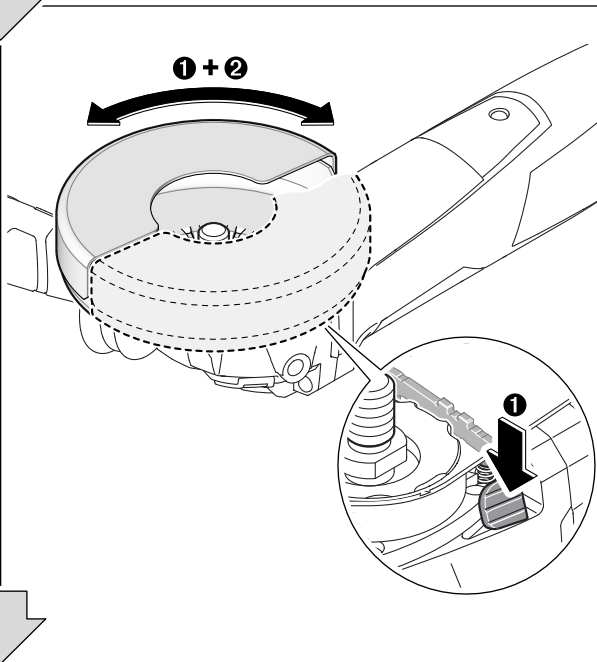
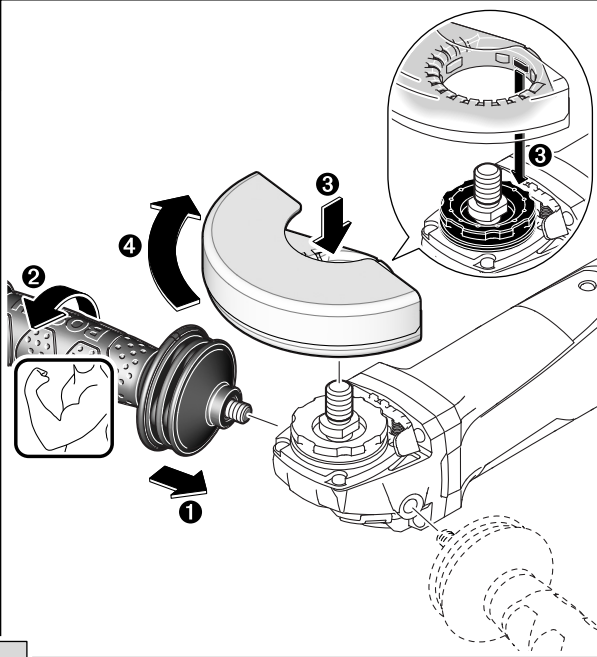
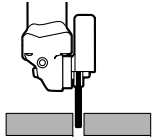

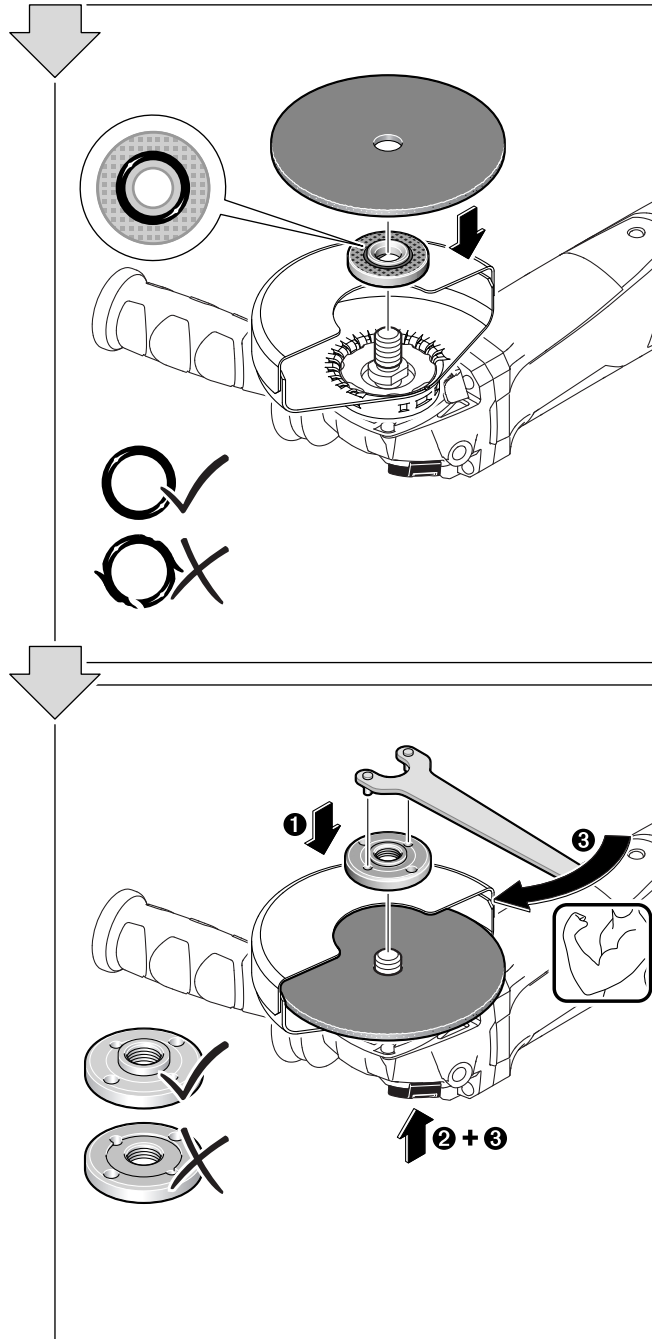

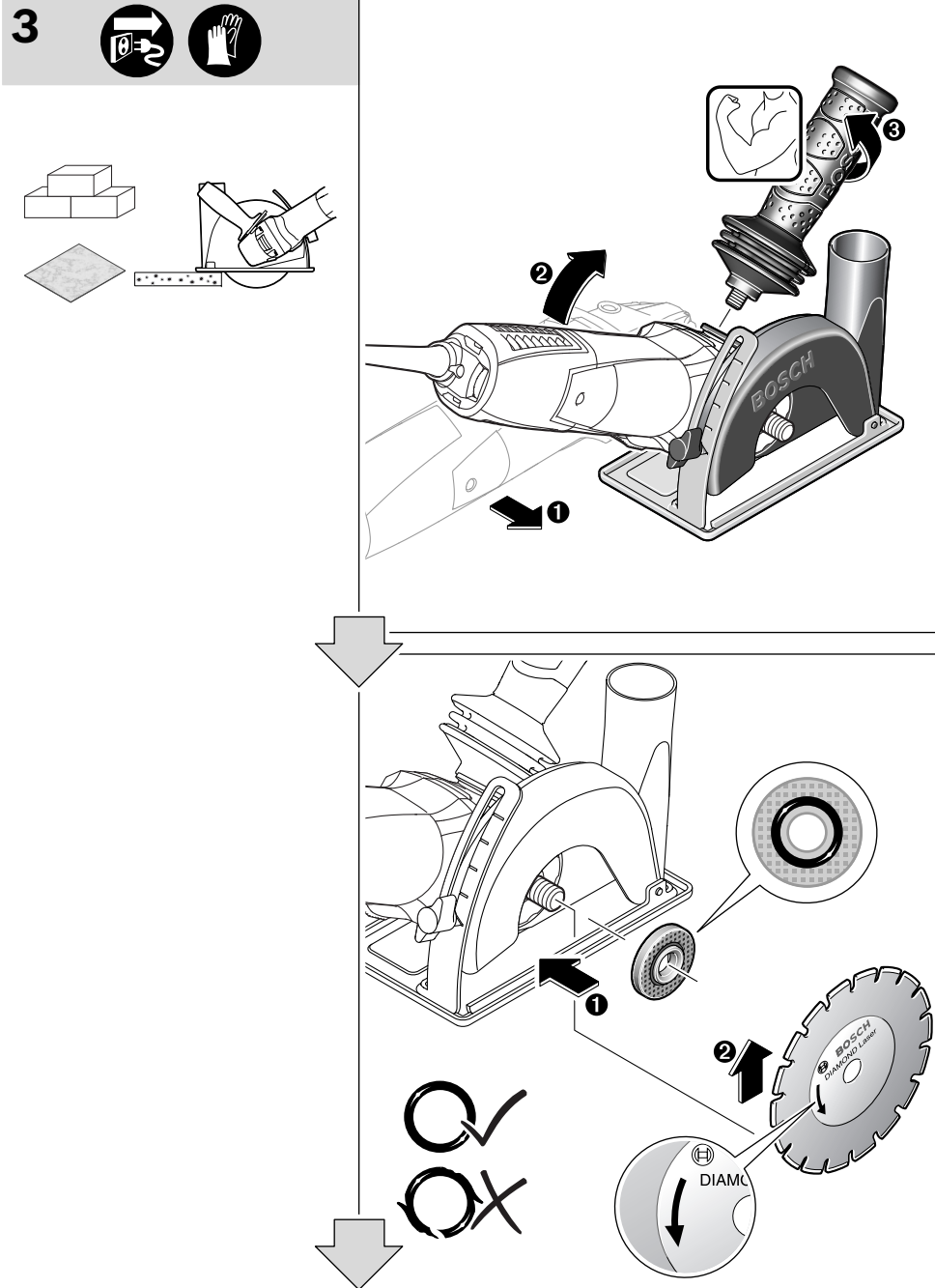

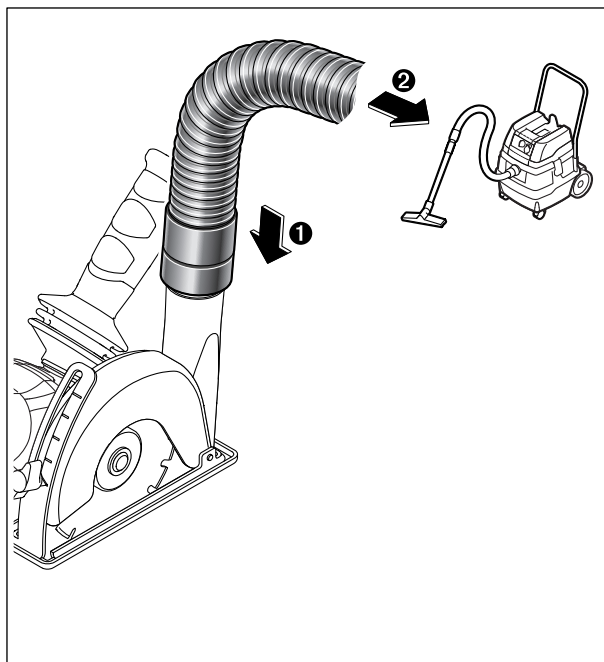
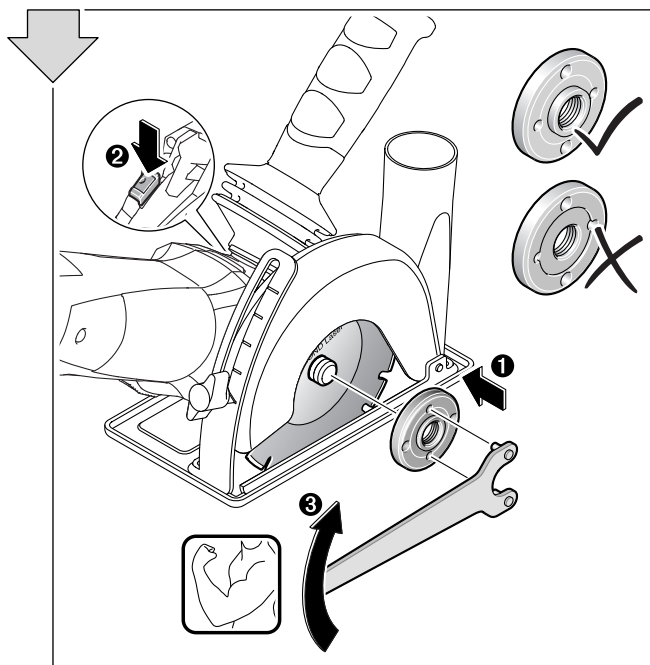

4

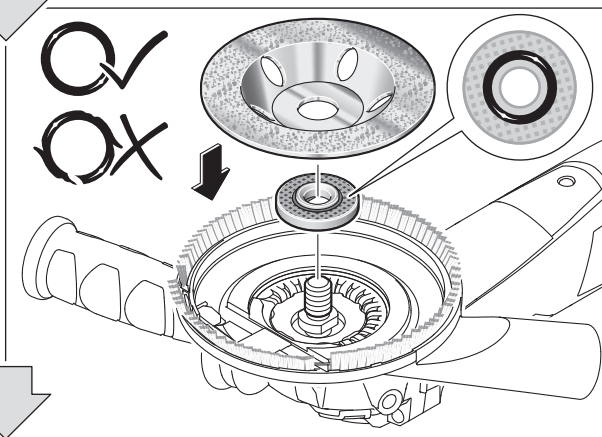
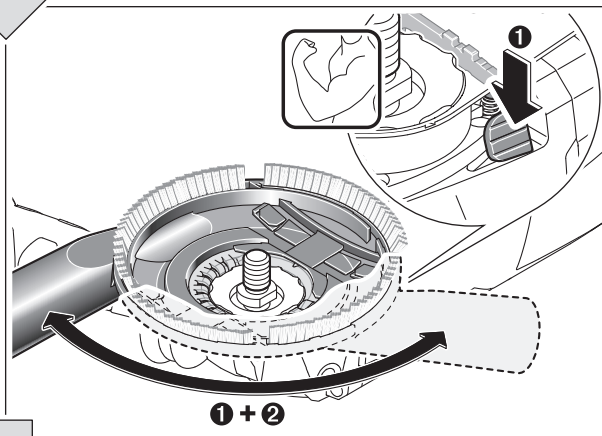
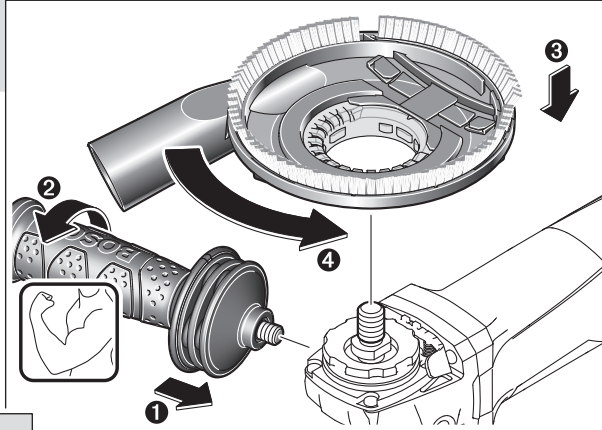
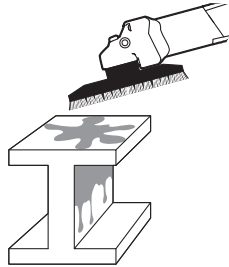

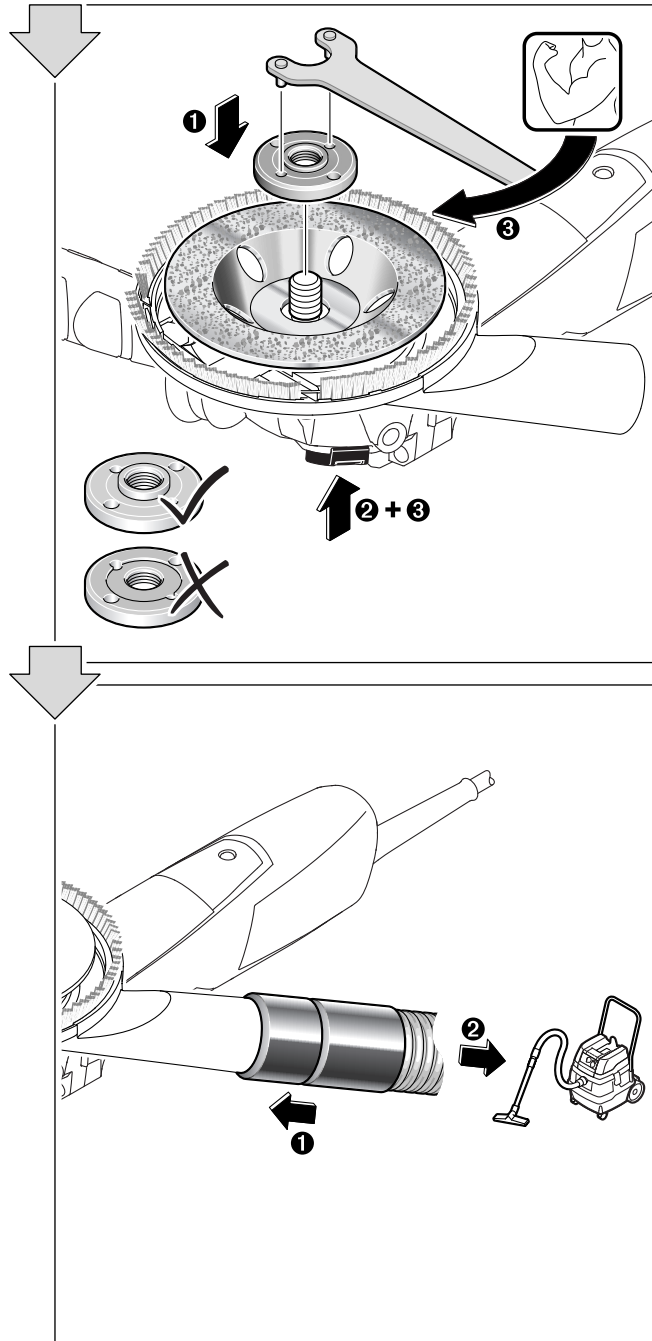

5

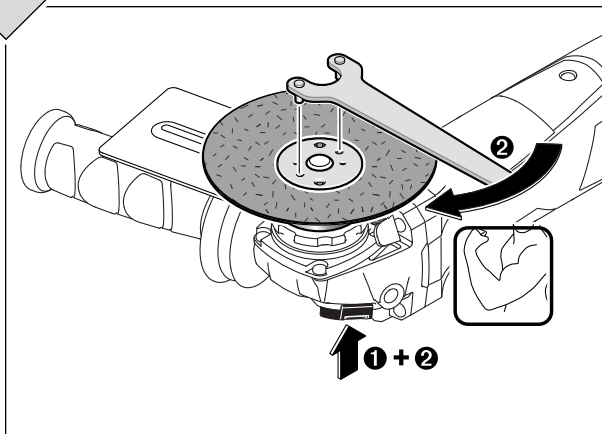
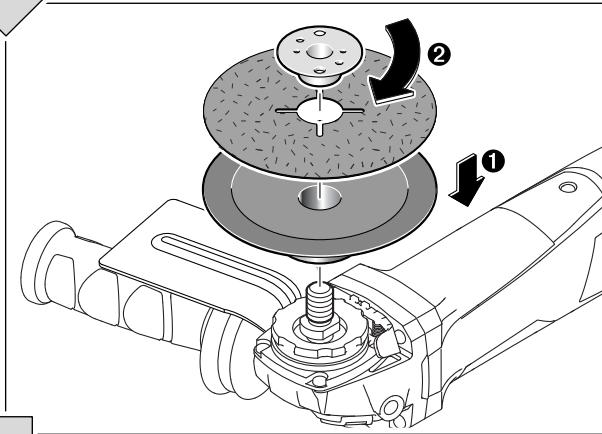
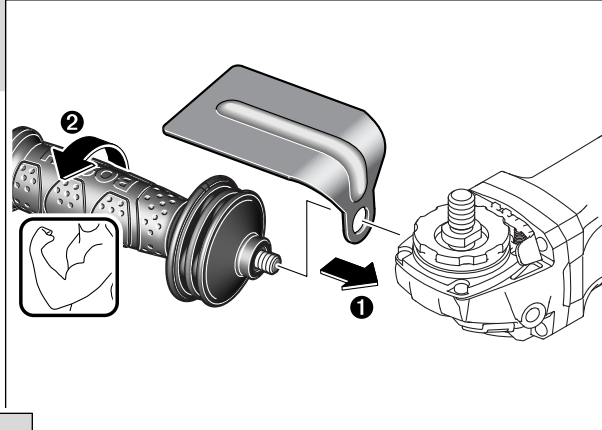
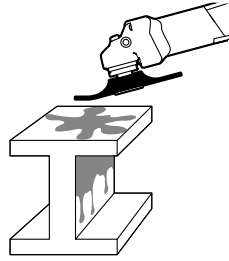

6

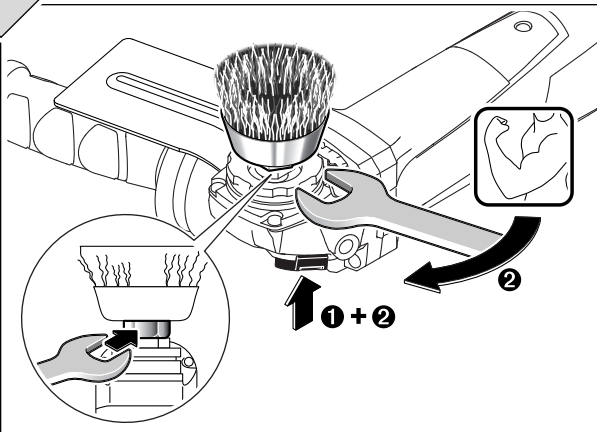
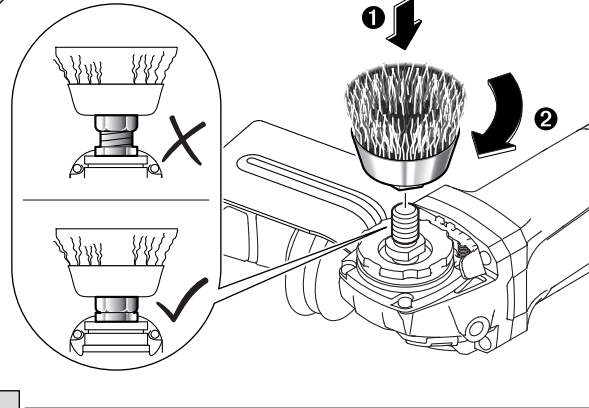
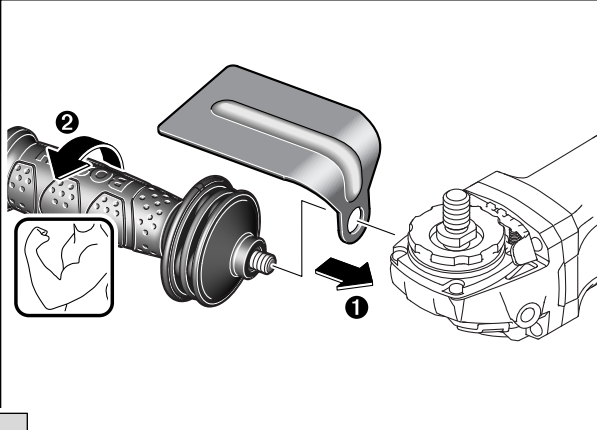
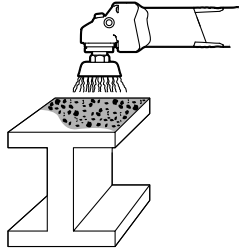

7

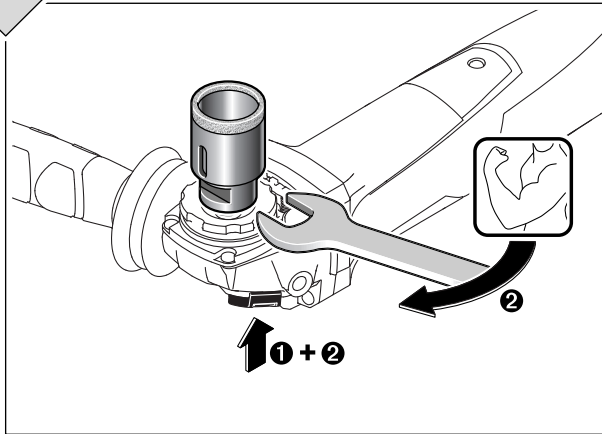
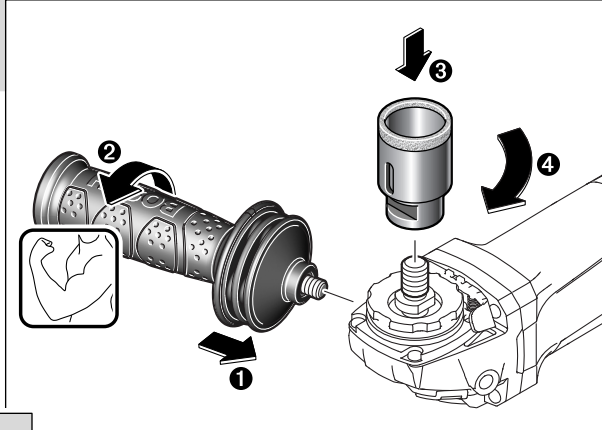
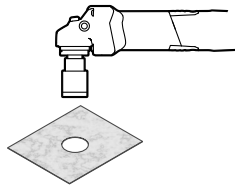

8

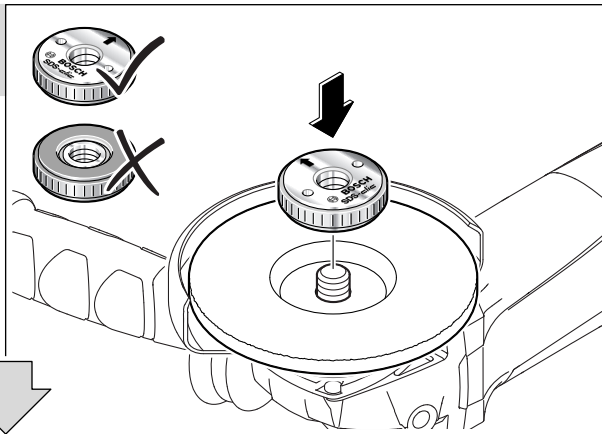
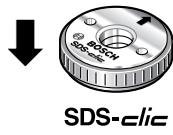

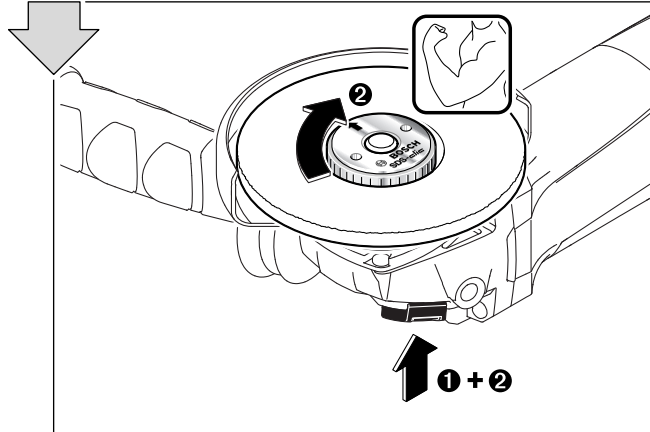

9

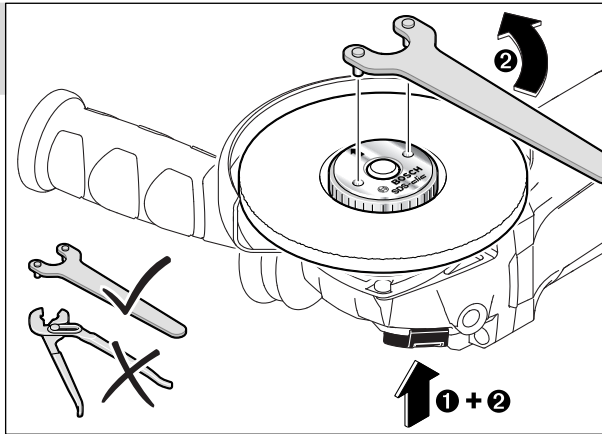
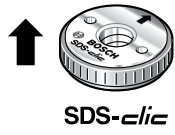

10

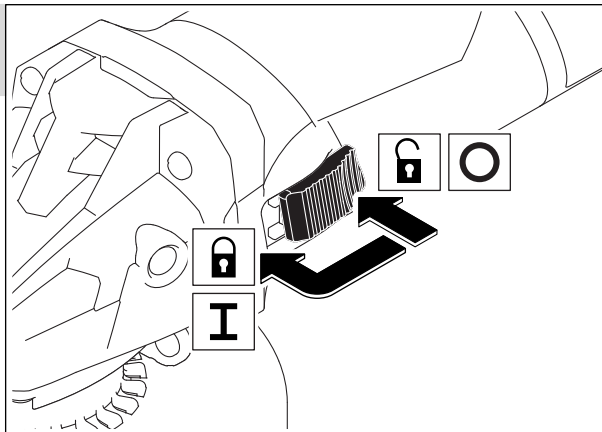

11

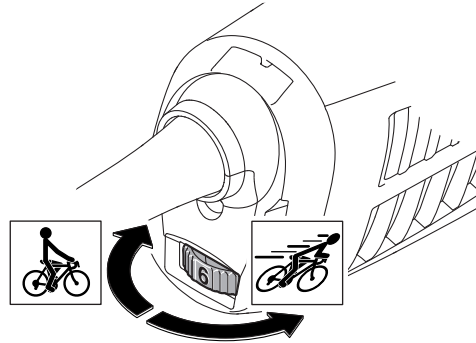
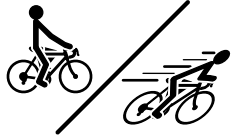

2 3

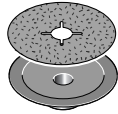

4 5 6

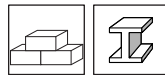

5 6



+

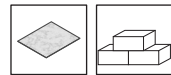
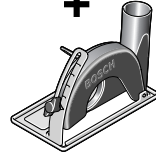

12

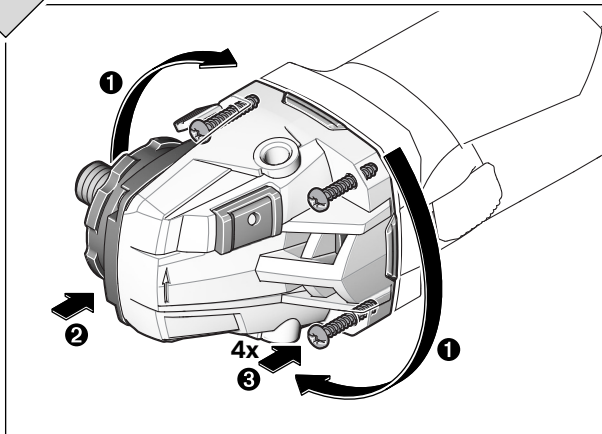
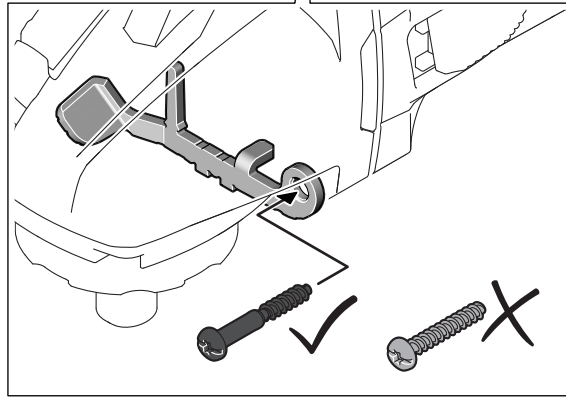
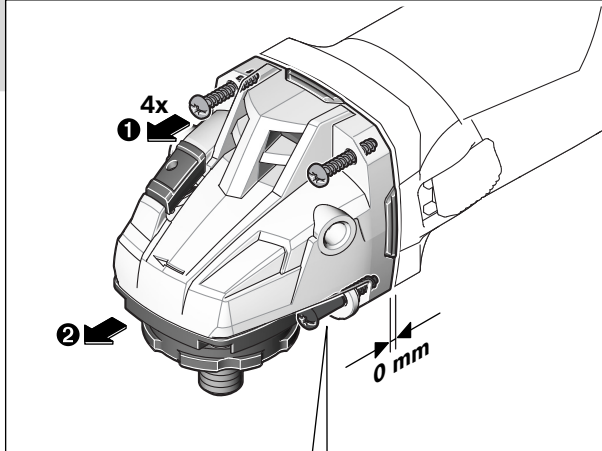
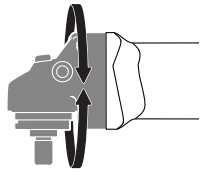



13



i+

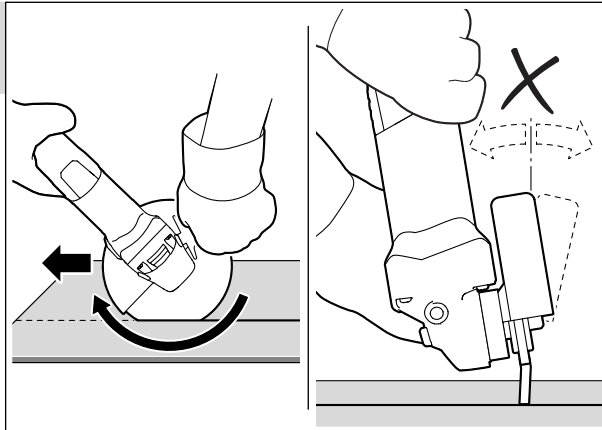





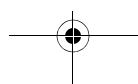
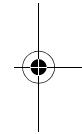
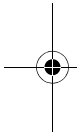
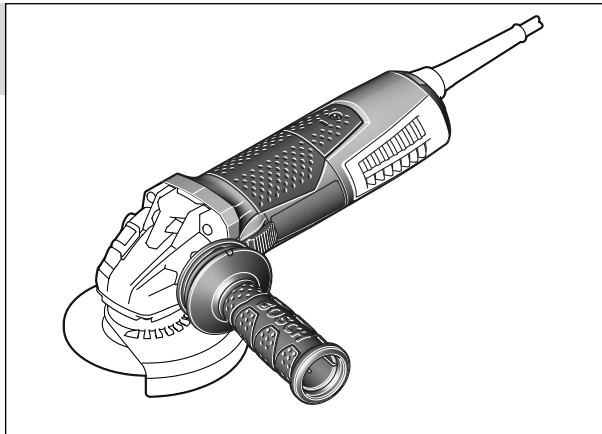

14

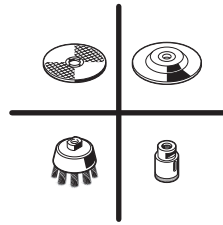
i+

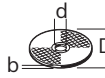

15

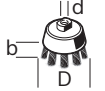

	max. [mm]		[mm]		
	D	b			
	115	7	22,2	11500	80
	125	7	22,2	11500	80
	150	7	22,2	9300	80
	115	-	-	11500	80
	125	-	-	11500	80
	75	30	M 14	11500	45
	82	-	M 14	11500	80

