

# FLIR 200.2027.25

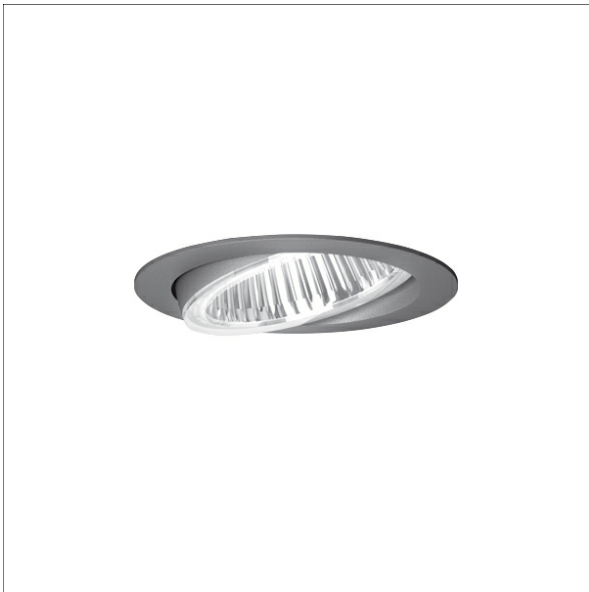

Farbe	Artikelnummer	EAN
schwarz	636595	4043544391773
silber	636596	4043544391780
weiß	636597	4043544391797

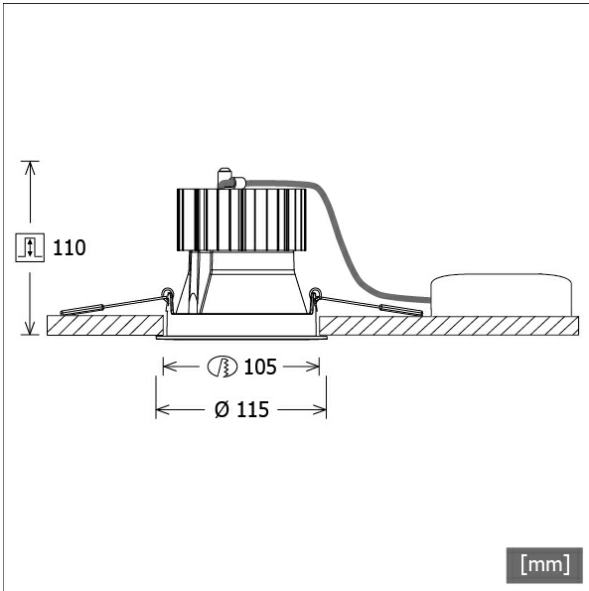

## Beschreibung

- Einbaustrahler mit optischen Designvarianten und breitem Anwendungsspektrum
- Lichtkopf 20° schwenkbar
- hohe Wartungsfreundlichkeit
- keine UV- und Wärmestrahlung
- Wärmemanagement mit Passivkühlung (Kühlkörper aus Aluminium)
- High-Performance Spiegelreflektor aus Aluminium mit präziser symmetrischer Abstrahlcharakteristik für maximale Lichtausbeute und optimale Entblendung
- Front-/Einbauring aus Zinkdruckguss mit Lichteffektring klar (weitere Dekor-/Lichteffektringe und Dekogläser sind als Option erhältlich)
- werkzeugloser Deckeneinbau mit Schnellspannfedern (automatische Anpassung der Deckenstärke)
- Anschluss an Betriebsgerät über Leuchtenkabel mit Mini-Clamp Steckverbindung
- Betriebsgerät (LED-Konverter) inklusive (Platzierung extern)

## Standardoptionen



## Sonderoptionen



## Lichttechnik / Normen

Leuchtmittel	LED Spot / CRI 80 / max. 2700 K
Lebensdauer	L90 B50 50.000 h L80 B50 100.000 h L80 B20 50.000 h
Systemleistung	27,0 W
Leuchten-Lichtstrom	max. 2820 lm
Systemeffizienz	104,44 lm/W
Moduleffizienz	157,68 lm/W
UGR 4H/8H 70/50/20	19,4/19,4 (C0/C90)
Abstrahlwinkel	25°
Versorgungsspannung	220 - 240 V / 50 Hz
Schutzklasse	III
Schutzart	IP20

## Abmessungen / Gewichte

Außendurchmesser	115 mm
Höhe	112 mm
Ausschnittsmaß (∅)	105 mm
Deckenstärke	1 - 25 mm
Einbautiefe	110 mm
Nettogewicht	0,87 kg
Bruttogewicht	0,95 kg

# FLIR 200.2027.25

## FLIR 200.2027.25

Flixx 200 Round (FLIRZ 200.05, 1xLED 27W 827/2700K 2820lm 15 °)

— C0/C180 cd / 1000 lm

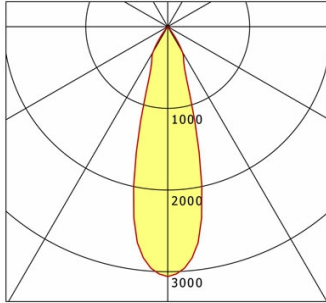

	C0	C90	C180	C270
0°	3059	3059	3059	3059
15°	1386	1386	1386	1386
30°	362	362	362	362
45°	16	16	16	16
60°	11	11	11	11
75°	5	5	5	5
90°	0	0	0	0
cd / 1000 lm				

Offset [m] Cone width [m] Illuminance [lx]

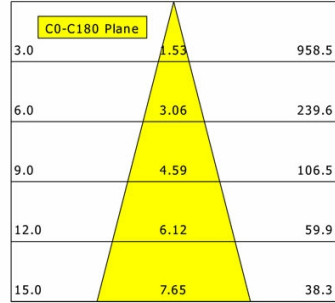

<b>η</b>	LED
Efficiency	105 lm/W
Direct/Indirect	↓ 100% / ↑ 0%
System Power	27 W
<b>UGR</b>	X=4H, Y=8H
Reflection factors	70/50/20
UGR C0/C180	19.4
UGR C90/C270	19.4
CIE Flux Codes	96 98 100 100 100
Ra/CRI	>80

LTS

## FLIR 200.2027.25

Flixx 200 Round (FLIRZ 200.25, 1xLED 27W 827/2700K 2740lm 15 °)

— C0/C180 cd / 1000 lm

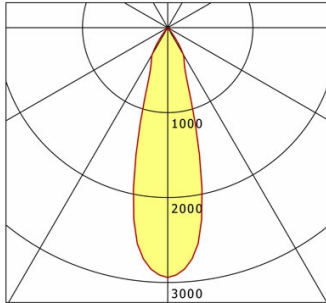

	C0	C90	C180	C270
0°	2942	2942	2942	2942
15°	1350	1350	1350	1350
30°	366	366	366	366
45°	19	19	19	19
60°	14	14	14	14
75°	4	4	4	4
90°	0	0	0	0
cd / 1000 lm				

Offset [m] Cone width [m] Illuminance [lx]

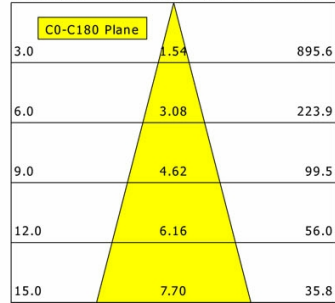

<b>η</b>	LED
Efficiency	102 lm/W
Direct/Indirect	↓ 100% / ↑ 0%
System Power	27 W
<b>UGR</b>	X=4H, Y=8H
Reflection factors	70/50/20
UGR C0/C180	19.7
UGR C90/C270	19.7
CIE Flux Codes	95 99 100 100 100
Ra/CRI	>80

LTS

## FLIR 200.2027.25

Flixx 200 Round (FLIRZ 200.24, 1xLED 27W 827/2700K 2660lm 15 °)

— C0/C180 cd / 1000 lm

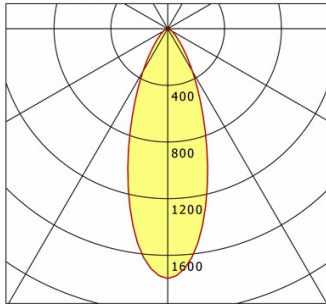

	C0	C90	C180	C270
0°	1764	1764	1764	1764
15°	1084	1084	1084	1084
30°	348	348	348	348
45°	95	95	95	95
60°	35	35	35	35
75°	14	14	14	14
90°	0	0	0	0
cd / 1000 lm				

Offset [m] Cone width [m] Illuminance [lx]

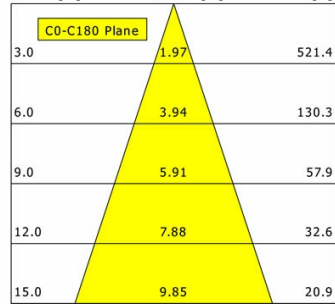

<b>η</b>	LED
Efficiency	99 lm/W
Direct/Indirect	↓ 100% / ↑ 0%
System Power	27 W
<b>UGR</b>	X=4H, Y=8H
Reflection factors	70/50/20
UGR C0/C180	25.4
UGR C90/C270	25.4
CIE Flux Codes	85 95 99 100 100
Ra/CRI	>80

LTS

# FLIRZ 200.2027.25

## Zubehör

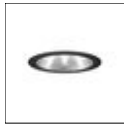

**FLIRZ 200.01**  
Dekorring schwarz



**FLIRZ 200.02**  
Dekorring silber



**FLIRZ 200.03**  
Dekorring weiß



**FLIRZ 200.04**  
Lichteffektring opal



**FLIRZ 200.05**  
Lichteffektring klar



**FLIRZ 200.06**  
Lichteffektring rot matt



**FLIRZ 200.07**  
Lichteffektring gelb matt



**FLIRZ 200.08**  
Lichteffektring blau matt



**FLIRZ 200.16**  
Lichteffektring rot transluzent



**FLIRZ 200.17**  
Lichteffektring gelb transluzent



**FLIRZ 200.18**  
Lichteffektring blau transluzent

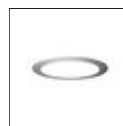

**FLIRZ 200.24**  
Dekoglas opal



**FLIRZ 200.25**  
Dekoglas klar