

BENNING MA 4

CEE measuring adapter (5-pin/3-pin)

Operating manual

Original English version

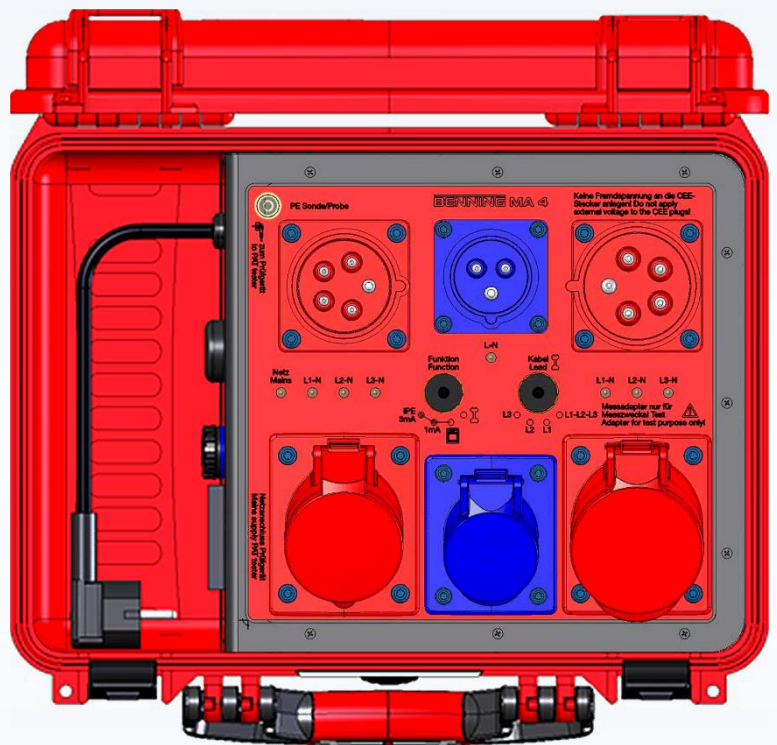

5116 de
Version 1.04
10218133
08.09.2020

Table of contents

1.	Application	1
1.1.	General functional description.....	1
2.	Safety notes and precautions	1
2.1.	Basic information about safety	1
2.2.	Symbols used.....	1
3.	Inspection characteristics of the measuring adapter	2
4.	Operating elements.....	3
5.	Connecting the measuring adapter	5
6.	Testing with the measuring adapter	5
6.1.	Testing of three-phase devices with functional test	6
6.1.1.	R_{PE} – Protective Conductor Resistance.....	6
6.1.2.	$R_{Insu\ 1}$ (LN-PE)	6
6.1.3.	$R_{Insu\ 2}$ (sec.-PE)	7
6.1.4.	$R_{Insu\ 3}$ (LN-sec.).....	7
6.1.5.	$R_{Insu\ 4}$ (LN-accessible parts without PE)	8
6.1.6.	I_{PE} – Protective conductor current	8
6.1.7.	I_{Cont} – Contact current.....	9
6.1.8.	I_{Leak} – Device leakage current.....	9
6.1.9.	I_{PLeak} – Patient leakage current.....	10
6.1.10.	Functional test.....	10
6.2.	Testing of three-phase devices with alternative leakage current method	11
6.2.1.	R_{PE} – Protective conductor resistance.....	11
6.2.2.	$R_{Insu\ 1}$ – (LN-PE)	12
6.2.3.	$R_{Insu\ 2}$ – (sec.-PE)	12
6.2.4.	$R_{Insu\ 3}$ – (LN-sec.)	12
6.2.5.	$R_{Insu\ 4}$ – (LN-accessible parts without PE).....	13
6.2.6.	I_{PE} – protective conductor current (alt. leak.)	13
6.2.7.	I_{Cont} – Contact current (alt. leak.)	13
6.2.8.	I_{Leak} – Device leakage current (alt. leak.)	14
6.2.9.	I_{PLeak} – Patient leakage current (alt. leak.)	14
6.3.	Testing of extension cables	15
6.3.1.	R_{PE} – Protective conductor resistance.....	15
6.3.2.	R_{PE} (e. g. CEE 5-pin, 32 A).....	15
6.3.3.	$R_{Insu\ 1}$ – (LN-PE)	16
6.3.4.	Functional test and phase sequence test of cables	16
6.3.5.	Function table.....	18
6.4.	Testing of PRCDs and mobile power distributors (RCDs).....	18
7.	Internal R_{PE} resistance of the measuring adapter.....	19
8.	Technical data.....	20
9.	Maintenance.....	20
10.	Optional accessories	20
11.	Warranty terms.....	20
12.	Service contacts	21

1. Application

The measuring adapter helps you to test portable devices. Due to its robust design, it is particularly suited for being used in industrial environments. The measuring adapter is easy to use and thus allows the user to work efficiently and quickly.

You can test devices and extension cables being provided with the following connectors complying with **IEC 60309-1**.

CEE connector:

- 16 A, 50 Hz to 60 Hz, 230 V, L+N+PE, 6h
- 16 A, 50 Hz to 60 Hz, 380 V to 415 V, 3L+N+PE, 6h
- 32 A, 50 Hz to 60 Hz, 380 V to 415 V, 3L+N+PE, 6h

To do this, connect the measuring adapter to an appliance tester for testing portable devices according to **DIN VDE 0701-0702, DIN EN 62353 (VDE 0751-1)** or **DIN EN 60974-4 (VDE 0544-4)**.

For connection of the measuring adapter, the appliance tester must be equipped with a shock-proof socket. Depending on the type of test, a CEE 16 A or 32 A socket may also have to be available. For the CEE 16 A, an optional adapter cable (part no. 044163) is required.

The measuring adapter is suited to be connected to the following appliance testers:

- BENNING ST 725
- BENNING ST 750 / ST 750 A / ST 755 / ST 760
- Devices of other manufacturers

The measuring adapter can be used for the following tests:

- Protective conductor resistance (R_{PE})
- Insulating resistance (R_{Insu})
- Functional test and phase sequence test of cables
- Alternative leakage current:
 - e. g. protective conductor current (I_{PE}), contact current (I_{Cont}), device leakage current (I_{Leak}), patient leakage current (I_{PLeak})
- Differential current measuring method
 - I_{PE}
 - Leakage current
- Direct measurement
 - Contact current
 - Patient leakage current
- Functional test
- Ua
- Welding equipment (ST 760)
- PRCD



The manufacturers' specifications and normative restrictions with regard to alternative leakage current testing and appliance tests must be adhered to. To do this, thoroughly read the notes stated in the corresponding standard, in the manufacturers' specifications of the test sample and in the operating manual of the appliance tester.

1.1. General functional description

The MA 4 measures the fault current from the test sample using the differential current measuring method. This current is applied on the N and PE line of the tester, so that this fault current can be measured by testers using the differential current measuring method or the direct measuring method with 1 kΩ in the PE of the tester. Deviating measuring resistances in the PE can lead to an incorrect current applied.

2. Safety notes and precautions

2.1. Basic information about safety

The measuring adapter has been designed and tested in compliance with the safety requirements according to **IEC/ EN 61010-1/ VDE 0411-1**.

All electrically conductive parts of the housing are connected to the protective conductor system (according to **IEC 61140, protection class I**).

The measuring adapter must be used only for testing in environments of measuring category **CAT II** according to **IEC/ EN 61010-1**.

Make sure not to connect and test more than one test sample or one extension cable at a time.

The measuring adapter must be operated under supervision only.

In case of proper use according to the specifications, the safety of both the user and the device is ensured.

Read this operating manual and the operating manual of the appliance tester carefully and thoroughly before using the product. Please observe all instructions of the relevant operating manuals.

The measuring adapter must not be used:

- with the housing being open,
- in case of visible external damage,
- in case of damage of the CEE connectors, CEE sockets, connecting line or connector,
- in case of strong excessive strain or if the load limits stated in the technical data have been exceeded,
- if the device has been stored under unfavourable conditions for a longer period of time (high exposure to dust, moisture or excessive temperatures).

Non-observance might involve damaging or destruction of the measuring adapter and/or the connected test sample!

2.2. Symbols used



Attention! Danger! Please observe documentation!



Warning of dangerous voltage!



Note to be observed imperatively

CAT II

Device of measuring category II (max. 300 V)



Ground (voltage against ground)



This symbol on the measuring adapter means that the measuring adapter complies with the relevant EU directives.



The device must not be disposed of via the domestic waste. Further information regarding the WEEE mark can be accessed on the Internet by entering the search term "WEEE".



Instructions

3. Inspection characteristics of the measuring adapter

All tests that can be carried out with your appliance tester for devices with shock-proof socket and that are supported by the measuring adapter can now be performed in an identical way for devices with CEE connector.

Please observe the following aspects during tests using your appliance tester:

- When testing the protective conductor resistance, the value of the measured protective conductor resistance increases by the share caused by the protective conductor line of the measuring adapter.

In case of measuring results near the admissible limiting value, measure the protective conductor resistance of the measuring adapter at the PE connection of its CEE socket and subtract it from the total measuring value of the system.

Alternatively, when using the appliance testers BENNING ST 755 / ST 760, a probe calibration can be carried out at the PE connection of the CEE socket.



If the measuring adapter is not used, the probe must then be calibrated again at the PE connection of the appliance tester.

-
- During insulating resistance or alternative leakage current tests, the three phases L1, L2, L3 and the neutral conductor N of the test sample are shorted.

4. Operating elements

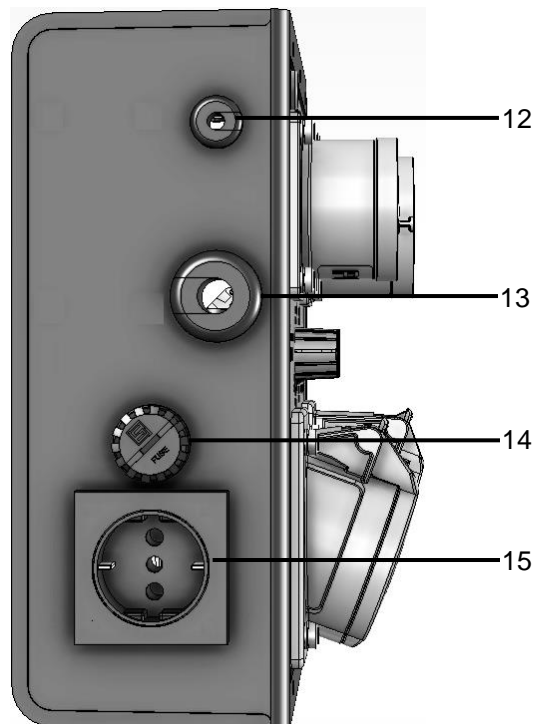
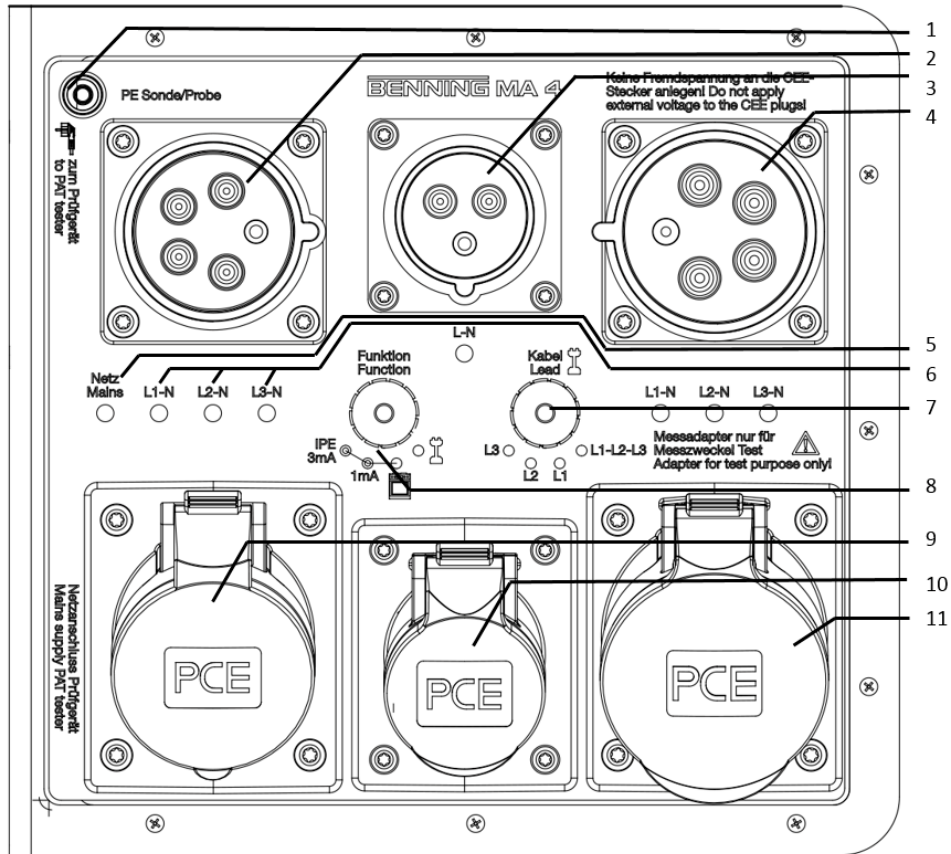

Pos.	Meaning	
1	PE socket for PE test probe (for RPE cable test)	
2	CEE connector: 16 A, 50 Hz to 60 Hz, 380 V to 415 V	3L+N+PE, 6h
3	CEE connector: 16 A, 50 Hz to 60 Hz, 230 V	L+N+PE, 6h
4	CEE connector: 32 A, 50 Hz to 60 Hz, 380 V to 415 V	3L+N+PE, 6h
5	The mains LED lights up as soon as 230 V are connected to the shock-proof plug.	
6	The LED indications L1-N, L2-N, L3-N light up as soon as the corresponding connections have been established (e. g. via extension cables).	
7	Rotary switch Cable	The switch can be used to toggle between all three phases and the individual phases. This function is active when the rotary function selector switch (pos. 8) is set to the cable test function. The testing personnel can use this to detect or limit faults during the cable function test. The switch is not used during the functional testing of devices.
8	Rotary switch Function	This rotary selector switch can be used to toggle between cable test, appliance test, appliance test 1 mA and appliance test +3 mA. The IPE currents of 1 mA and 3 mA are only generated when testing with mains voltage. No fault current is generated in the switch position of cable testing!
9	CEE socket: 16 A, 50 Hz to 60 Hz, 380 V to 415 V	CEE socket: 16 A, (3L+N+PE, 6h)
10	CEE socket: 16 A, 50 Hz to 60 Hz, 230 V	CEE socket: 16 A, (L+N+PE, 6h)
11	CEE socket: 32 A, 50 Hz to 60 Hz, 380 V to 415 V	CEE socket: 32 A, (3L+N+PE, 6h)
12	Shock-proof plug to the tester	Shock-proof plug (types E and F)
13	Mains connection	CEE 32 A connector (3L+N+PE, 6h)
14	Mains fuse	T 16 A (6.3 x 32)
15	Mains connection for tester	Shock-proof socket (type E)

5. Connecting the measuring adapter



The measuring adapter is equipped with a PTC thermistor as short-circuit protection for cable testing, but not for appliance testing.

Use the measuring adapter only for the intended tests described in this manual.



The manufacturers' specifications or normative restrictions with regard to all tests involved must be adhered to.

To do this, thoroughly read the notes stated in the corresponding standards, in the manufacturers' specifications of the test sample and in the operating manual of the appliance tester.

Before you can start testing, you have to connect the measuring adapter to your appliance tester.

To do this, proceed as follows:

- Make sure that the appliance tester you are using is ready for operation.
- Connect the shock-proof plug of the measuring adapter to the test socket of your appliance tester.

Connecting the measuring adapter to the appliance tester

This is a connection method for appliance testing and cable testing.

For appliance testing, the MA 4 must be connected to the mains. Connect the ST 755 / 760 to the socket of the MA 4.

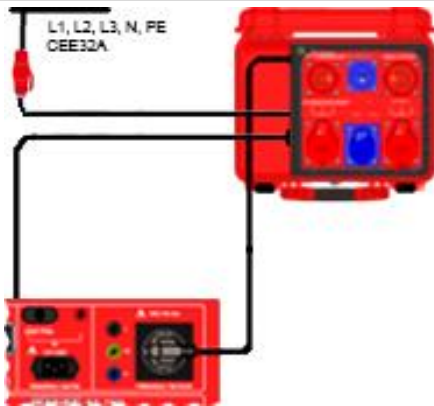

Connection diagram

6. Testing with the measuring adapter

Testing the adapter for compatibility with third-party manufacturers / self-testing the device

In the switch position for appliance testing +1 mA and in the switch position for appliance testing +3 mA, an internal fault current is generated in the MA 4. The fault current becomes detectable for the measuring instruments when 230 V are applied to their test socket. For appliance testing, the MA 4 must be connected to the mains via the CEE 32 A cable. If such a functional test is carried out, no fault current is generated in the switch position for appliance testing without any test samples being connected. By selecting the position for appliance testing +1 mA, a fault current of approx. 1 mA is generated. The fault current depends on the mains voltage. Now, it should be possible to measure this fault current by means of the tester. The fault current is applied on the N conductor and on the PE conductor of the measuring instrument.



The current in the N conductor can be determined by any measuring instrument using the differential current measuring method. In order to detect the applied current in the PE, a measuring resistance of 1 kΩ is required. Otherwise, a deviating applied fault current will occur. In case of the ST 755 / 760, this load is automatically selected as soon as three-phase measurement has been activated.

For this test, no test sample may be connected!

Before carrying out the functional test and all tests for which the test sample must be supplied with mains voltage and put into operation, make sure that there are no short-circuits in the test sample within phases L1, L2, L3 and the neutral conductor N! Non-observance might involve damaging or destruction of the measuring adapter and possibly of the test sample as well!



Within the framework of the functional test, it is not possible to determine the values of the power and current consumption of the test sample by means of the measuring adapter. The displayed values refer to the power consumption of the measuring adapter itself.

6.1. Testing of three-phase devices with functional test



For **appliance testing** with the differential current measuring method, the measuring adapter must be connected to the mains via the CEE 32 connector.

6.1.1. R_{PE} – Protective Conductor Resistance

Before testing



Before starting the test, determine the internal R_{PE} resistance of the measuring adapter (see chapter 7).



Disconnect the test sample from the mains supply!

Switch the rotary switch (7) of the **measuring adapter** to position "L1-L2-L3".

The rotary switch (8) of the **measuring adapter** must be set to the position for **appliance testing**.

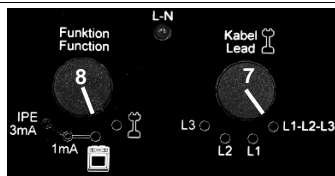

Portable test sample

- Connect the CEE connector of the test sample to the CEE socket of the **measuring adapter**.
- Start the R_{PE} measurement on your appliance tester.
- Use the test probe to scan all accessible conductive parts of the test sample that are connected to the protective conductor.

As a result, you will obtain the measured R_{PE} value of the test sample.

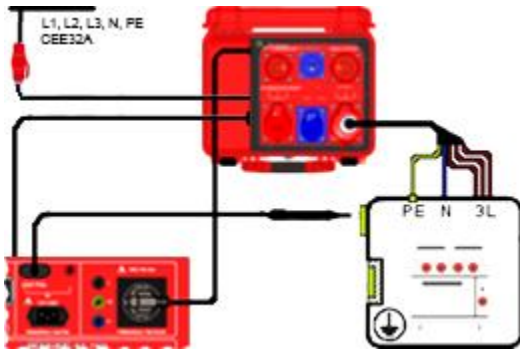

Connection diagram

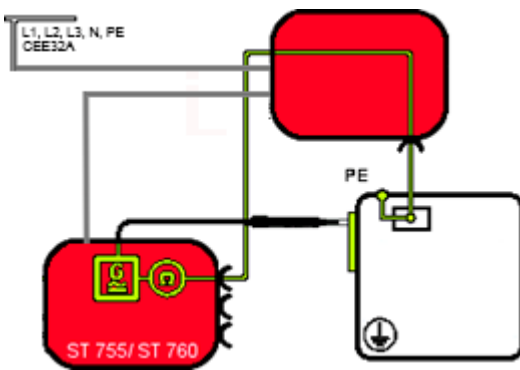

Circuit diagram

6.1.2. R_{Insu} 1 (LN-PE)

Portable test sample

- Connect the CEE connector of the test sample to the CEE socket of the **measuring adapter**.
- Start the R_{Insu} measurement on your appliance tester.

The insulating resistance is measured between the bridged LN conductor and the PE of the shock-proof socket.

As a result, you will obtain the measured R_{Insu} value of the test sample.

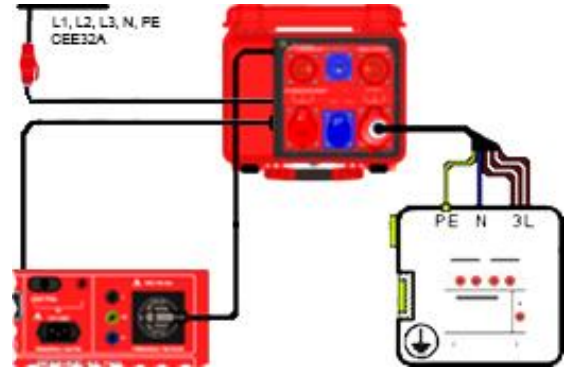

Connection diagram

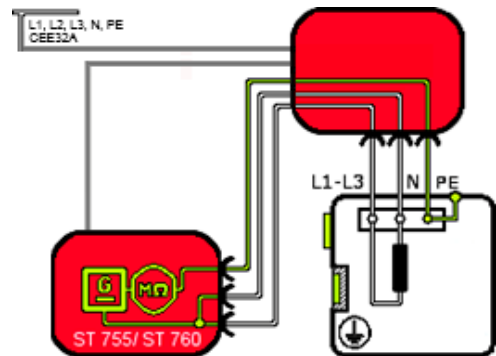

Circuit diagram

6.1.3. $R_{Insu\ 2}$ (sec.-PE)

Portable test sample

- Connect the CEE connector of the test sample to the CEE socket of the **measuring adapter**.
- Connect the test probe to the bridged secondary side of the device.
- Start the R_{Insu} measurement on your appliance tester.

As a result, you will obtain the measured R_{Insu} value of the test sample.

The insulating resistance is measured between the PE of the test socket and the secondary side (probe).

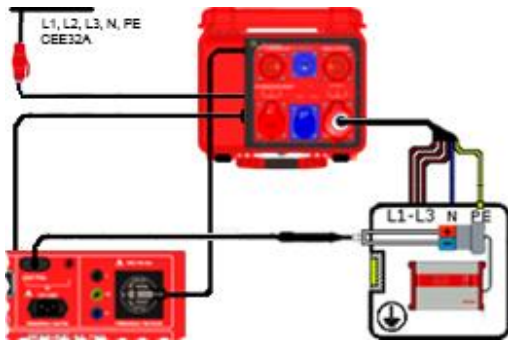

Connection diagram

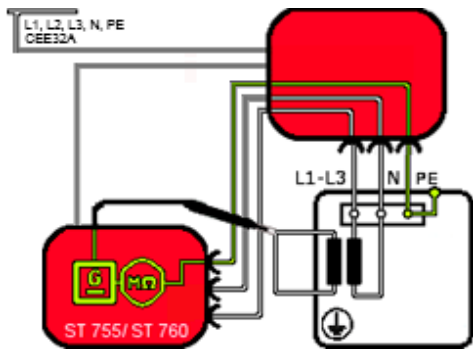

Circuit diagram

6.1.4. $R_{Insu\ 3}$ (LN-sec.)

Portable test sample

- Connect the CEE connector of the test sample to the CEE socket of the **measuring adapter**.
- Connect the test probe to the bridged secondary side of the device.
- Start the R_{Insu} measurement on your appliance tester.

As a result, you will obtain the measured R_{Insu} value of the test sample.

The insulating resistance is measured between the bridged LN conductor and the secondary side (probe).

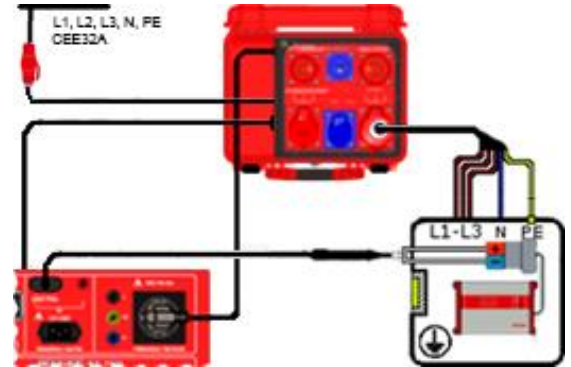

Connection diagram

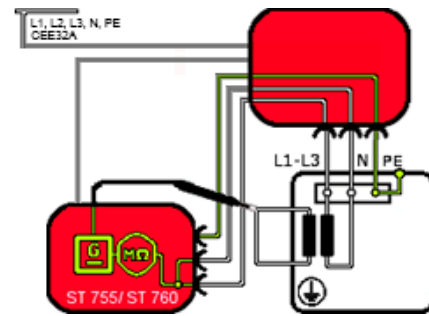

Circuit diagram

6.1.5. R_{Insu} 4 (LN-accessible parts without PE)

Portable test sample

- Connect the CEE connector of the test sample to the CEE socket of the **measuring adapter**.
- Start the R_{Insu} measurement on your appliance tester.
- Use the test probe to scan all accessible conductive parts of the test sample that are not connected to the protective conductor.

As a result, you will obtain the measured R_{Insu} value of the test sample.

The testing voltage is applied to the bridged L and N conductors and measured to parts without PE connection.

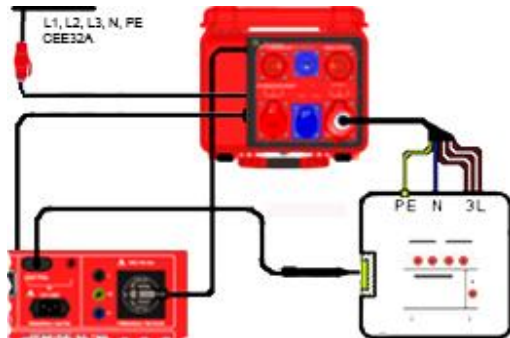

Connection diagram

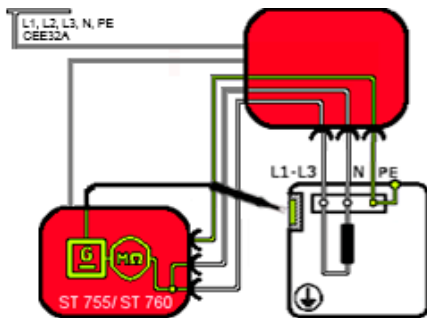

Circuit diagram

6.1.6. I_{PE} – Protective conductor current

Test procedure (VDE 0701 – 0702 / 0544-4)

Portable test sample

- Connect the CEE connector of the test sample to the CEE socket of the **measuring adapter**.
- Start the I_{PE} measurement on your appliance tester.

As a result, you will obtain the measured I_{PE} value of the test sample.

The test sample is supplied with mains voltage and must be tested in all switch positions (device functions).

- Please observe inductive/capacitive circuits.

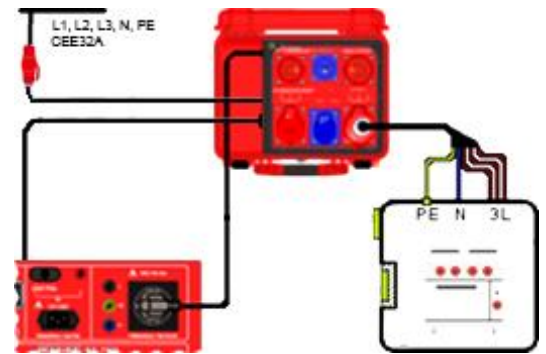

Connection diagram

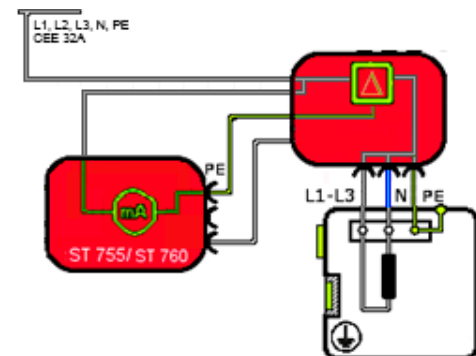

Circuit diagram

6.1.7. I_{Cont} – Contact current

Test procedure (VDE 0701 – 0702 / 0544-4)

Portable test sample

- Connect the CEE connector of the test sample to the CEE socket of the **measuring adapter**.
- Start the I_{Cont} measurement on your appliance tester.
- The test sample is supplied with mains voltage and must be tested in all switch positions (device functions).
- Use the test probe to scan all accessible conductive parts of the test sample that are not connected to the protective conductor.

As a result, you will obtain the measured I_{Cont} value of the test sample.

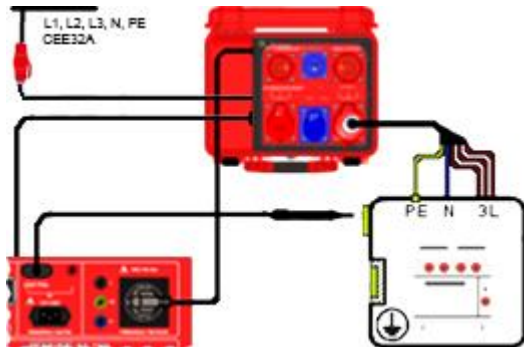

Connection diagram

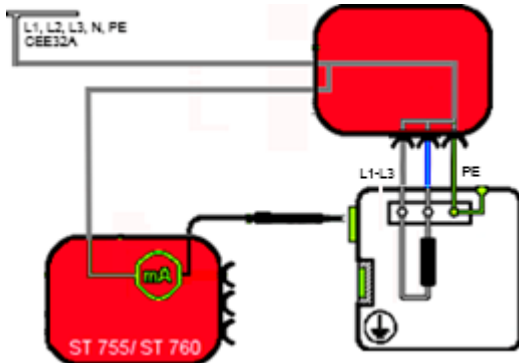

Circuit diagram

6.1.8. I_{Leak} – Device leakage current

Test procedure (VDE 0751-1)

Portable test sample

- Connect the CEE connector of the test sample to the CEE socket of the **measuring adapter**.
- Start the I_{Leak} measurement on your appliance tester.
- The test sample is supplied with mains voltage and must be tested in all switch positions (device functions).
- Use the test probe to scan all accessible conductive parts and applied parts.

As a result, you will obtain the measured I_{Leak} value of the test sample.

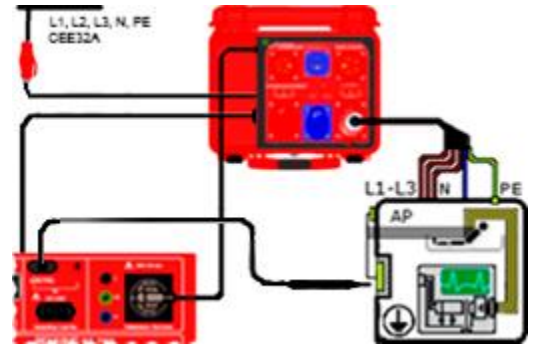

Connection diagram

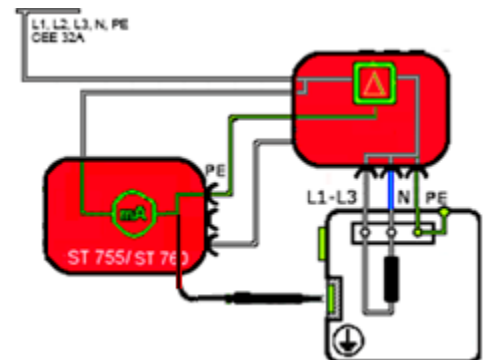

Circuit diagram

6.1.9. I_{PLeak} – Patient leakage current

Test procedure (VDE 0751-1)

Portable test sample

- Connect the CEE connector of the test sample to the CEE socket of the **measuring adapter**.
- Place the test sample onto an insulated surface.
- Start the I_{PLeak} measurement on your appliance tester.
- The test sample is supplied with mains voltage and must be tested in all switch positions (device functions).
- Use the test probe to scan all accessible conductive parts and applied parts.

As a result, you will obtain the measured I_{PLeak} value of the test sample.

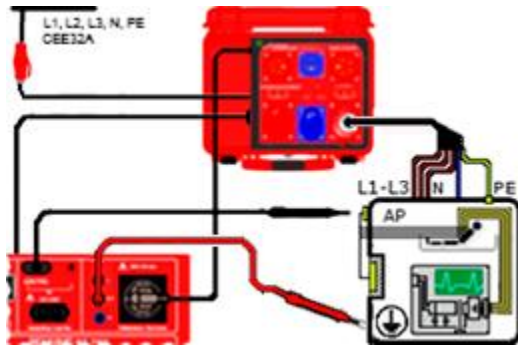

Connection diagram

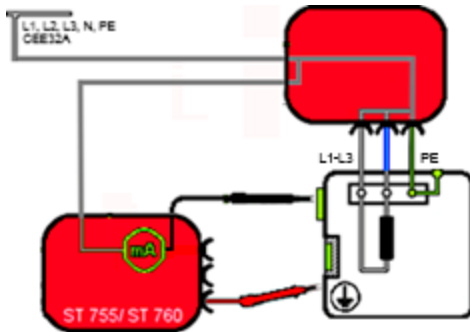

Circuit diagram

6.1.10. Functional test

Portable test sample

- Connect the CEE connector of the test sample to the CEE socket of the **measuring adapter**.
- The test sample is supplied with mains voltage and must be tested in all switch positions (device functions).
- Please observe inductive/capacitive circuits.

As a result, you will obtain the measured I_{PE} value of the test sample.

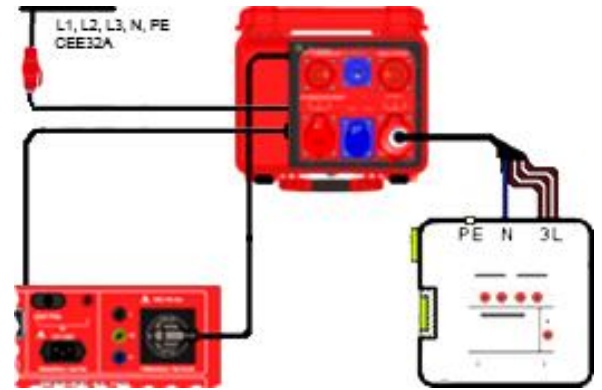

Connection diagram

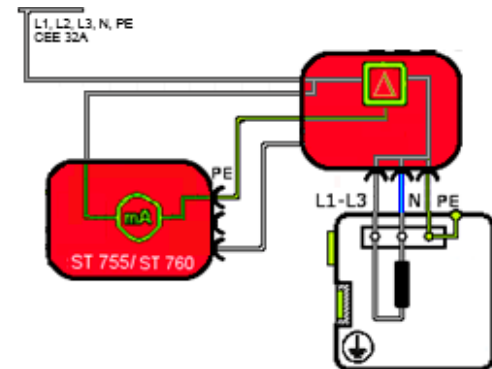

Circuit diagram

6.2. Testing of three-phase devices with alternative leakage current method

The alternative leakage current measuring method must not be carried out as an alternative to insulating resistance measurement. DIN VDE 0702 para. 5.7 expressly points out that measuring the alternative leakage current is an alternative measuring method for measuring the protective conductor current or contact current after an insulating resistance measurement has been passed. Exceptions are devices of protection class I with switched on heating elements and a total connected load of more than 3.5 kW. If such a device does not pass the insulating resistance measurement, it is still considered to be in proper condition if the protective conductor current according to paragraph 5.5 of the mentioned standard is not exceeded.

Symbol:

The **measuring adapter** can be used for measuring the following leakage or fault currents by means of the alternative leakage current measuring method, provided that the test is supported by the connected appliance tester:

- I_{PE} – protective conductor current
- I_{Cont} – contact current
- I_{Leak} – device leakage current
- I_{PLeak} – patient leakage current



For **alternative leakage current measurement**, the measuring adapter must **not** be connected to the mains via the CEE 32 connector.



Single-phase devices can be tested in the same way.

Before testing



Disconnect the test sample from the mains supply.

Switch the rotary switch (7) of the **measuring adapter** to position "L1-L2-L3".

The rotary switch (8) of the **measuring adapter** must be set to the position for **appliance testing**.

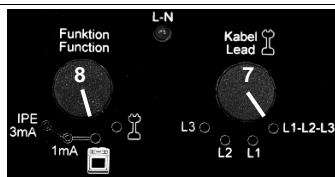

6.2.1. R_{PE} – Protective conductor resistance

Before testing



Before starting the test, determine the internal R_{PE} resistance of the measuring adapter (see chapter 7).



Disconnect the test sample from the mains supply!



The maximum testing current for R_{PE} measurement is **10 A!**

The rotary switch (7) of the **measuring adapter** can be used in any position for R_{PE} measurement.

The rotary switch (8) of the **measuring adapter** must be set to the position for **appliance testing**.

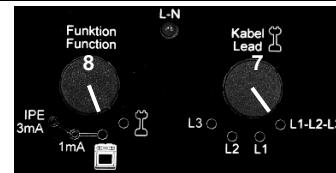

Test procedure (VDE 0701-0702)

Portable test sample

- Connect the CEE connector of the test sample to the corresponding CEE socket of the measuring adapter.
- Start the R_{PE} measurement on your appliance tester.
- Use the test probe to scan all accessible conductive parts of the test sample that are connected to the protective conductor.

Application

Portable test sample

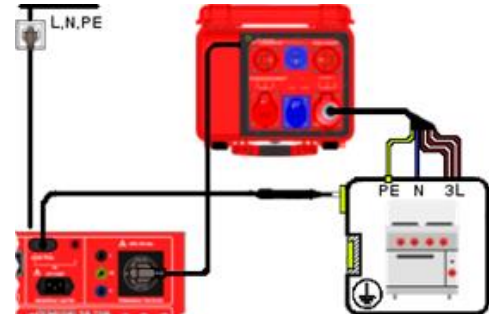

Connection diagram

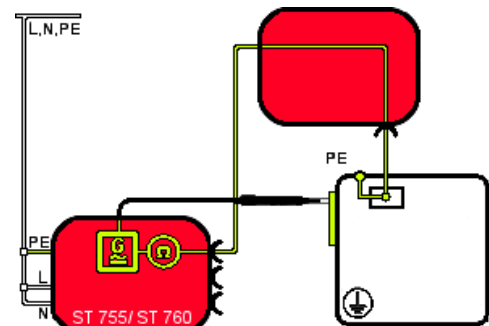

Circuit diagram

6.2.2. $R_{Insu} 1 - (LN-PE)$

Before testing



Disconnect the test sample from the mains supply.

Switch the rotary switch (7) of the **measuring adapter** to position "L1-L2-L3".

The rotary switch (8) of the **measuring adapter** must be set to the position for **appliance testing**.

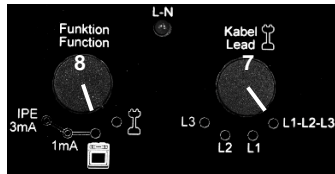

Test procedure (VDE 0701-0702)

Portable test sample

- Connect the CEE connector of the test sample to the CEE socket of the **measuring adapter**.
- Start the R_{Insu} measurement on your appliance tester. As a result, you will obtain the measured R_{Insu} value of the test sample.

Application

Portable test sample

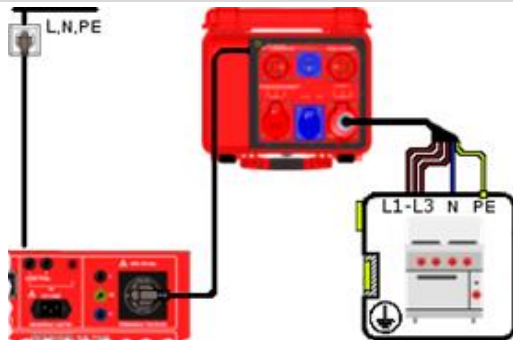

Connection diagram

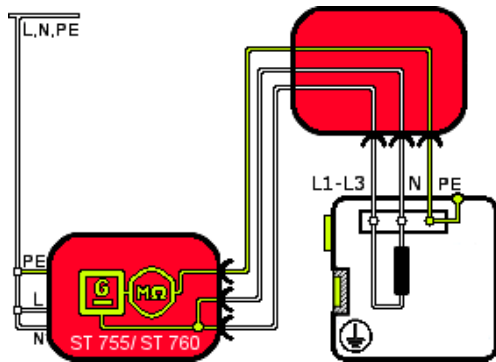

Circuit diagram

6.2.3. $R_{Insu} 2 - (sec.-PE)$

Portable test sample

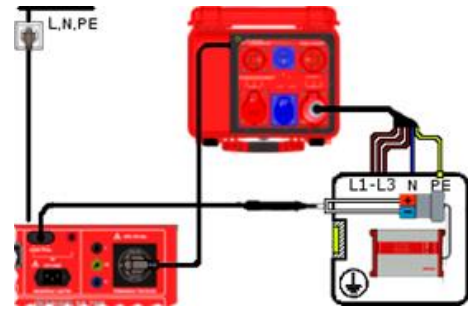

Connection diagram

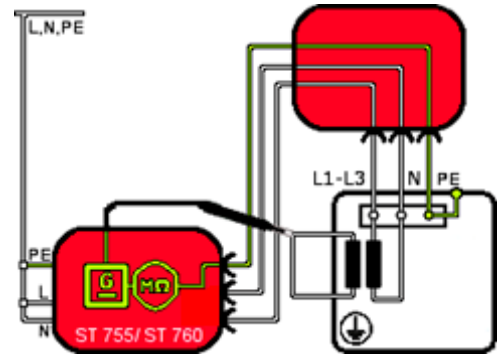

Circuit diagram

6.2.4. $R_{Insu} 3 - (LN-sec.)$

Portable test sample

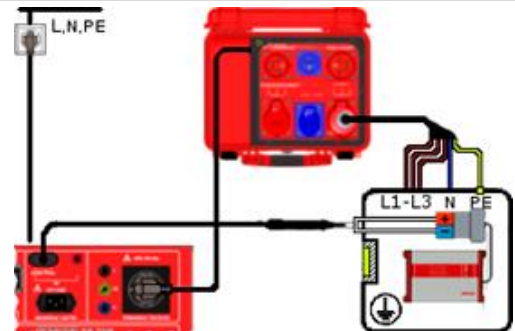

Connection diagram

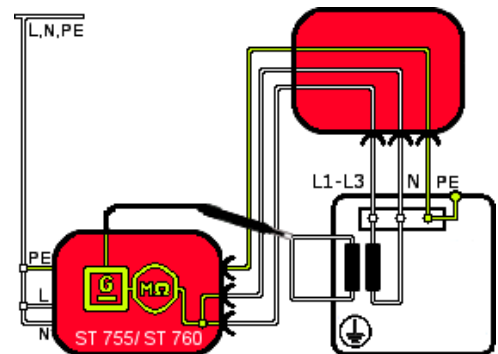

Circuit diagram

6.2.5. $R_{Insu} 4$ – (LN-accessible parts without PE)

Portable test sample

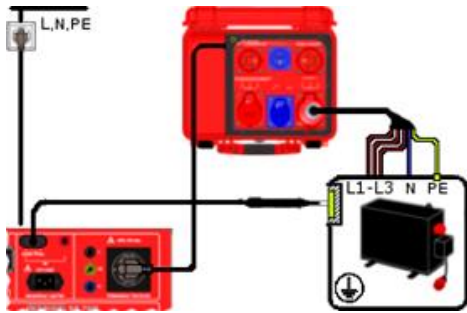

Connection diagram

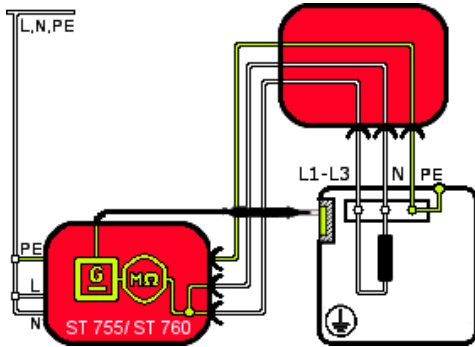

Circuit diagram

6.2.6. I_{PE} – protective conductor current (alt. leak.)

Test procedure (VDE 0701-0702)

Portable test sample

- Connect the CEE connector of the test sample to the CEE socket of the **measuring adapter**.
 - Start the I_{PE} measurement on your appliance tester.
- As a result, you will obtain the measured I_{PE} value of the test sample.

Application

Portable test sample

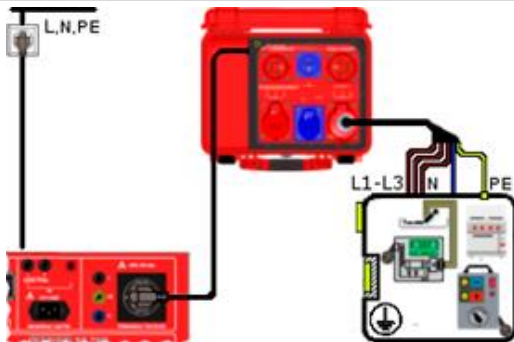

Connection diagram

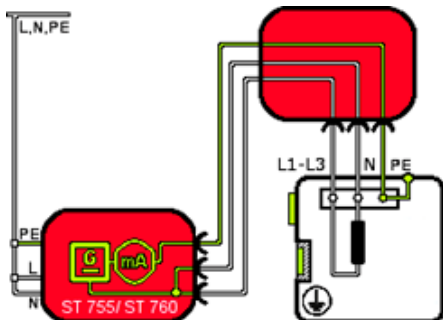

Circuit diagram

6.2.7. I_{Cont} – Contact current (alt. leak.)

Test procedure (VDE 0701-0702)

Portable test sample

- Connect the CEE connector of the test sample to the CEE socket of the **measuring adapter**.
- Start the I_{Cont} measurement on your appliance tester.
- Contact the test probe(s) of the appliance tester with all necessary measuring points.

As a result, you will obtain the measured I_{Cont} value of the test sample.

Application

Portable test sample

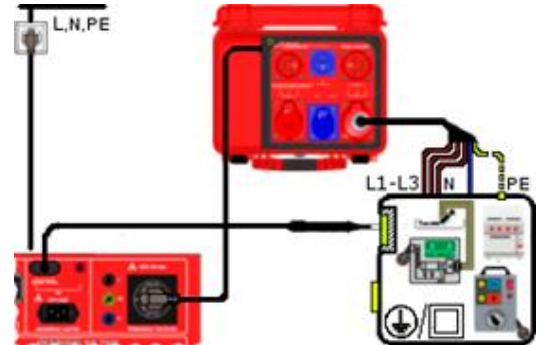

Connection diagram

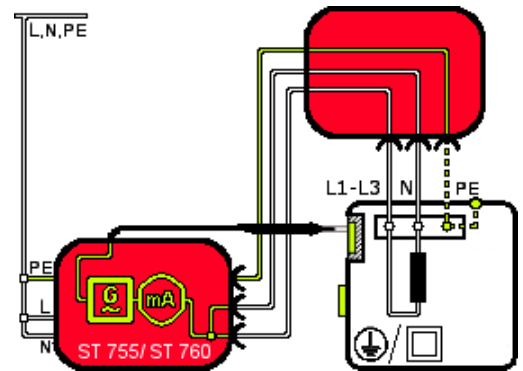

Circuit diagram

The contact current is determined for devices of **protection class II** that raise concerns as to an R_{Insu} measurement. Moreover, it is checked to prove the proper insulation capacity under mains voltage. This also applies to devices of **protection class I** with accessible conductive parts which are **not** connected to the protective conductor.

6.2.8. I_{Leak} – Device leakage current (alt. leak.)

Test procedure (VDE 0751-1)

Portable test sample

- Connect the CEE connector of the test sample to the CEE socket of the **measuring adapter**.
- Start the I_{Leak} measurement on your appliance tester.
- Contact the test probe(s) of the appliance tester with all necessary measuring points.

As a result, you will obtain the measured I_{Leak} value of the test sample.

Application

Portable test sample

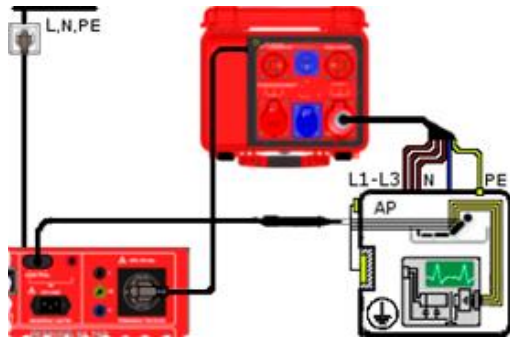

Connection diagram

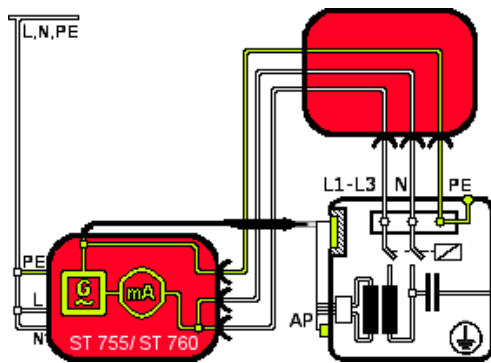

Circuit diagram

6.2.9. I_{PLeak} – Patient leakage current (alt. leak.)

Test procedure (VDE 0751-1)

Portable test sample

- Connect the CEE connector of the test sample to the CEE socket of the **measuring adapter**.
- Start the I_{PLeak} measurement on your appliance tester.
- Contact the test probe(s) of the appliance tester with all necessary measuring points.

As a result, you will obtain the measured I_{PLeak} value of the test sample.

Application

Portable test sample

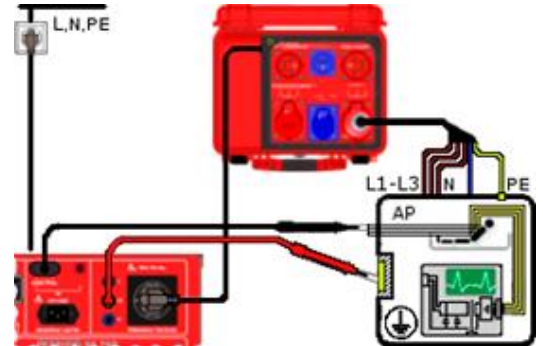

Connection diagram

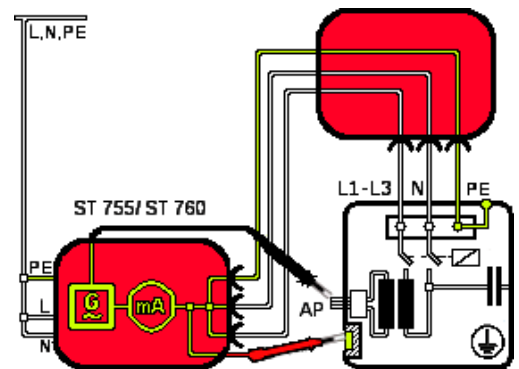

Circuit diagram

6.3. Testing of extension cables

Symbol:

6.3.1. R_{PE} – Protective conductor resistance

For these tests, the MA 4 must be connected to the mains using the CEE 32 connector. The ST 755 / 760 must be connected to the shock-proof socket of the measuring adapter.

Before testing

Before starting the test, determine the internal R_{PE} resistance of the measuring adapter (see chapter 7).

The maximum testing current for R_{PE} measurement is **10 A!**

The rotary switch (7) of the **measuring adapter** can be used in any position for R_{PE} measurement.

The rotary switch (8) of the **measuring adapter** must be set to the position for **cable testing**.

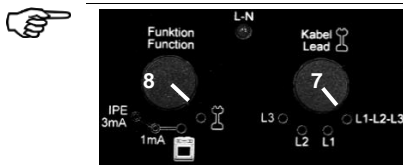

6.3.2. R_{PE} (e. g. CEE 5-pin, 32 A)

Test procedure (VDE 0701-0702)

Cable test

- Connect both cable connections to the corresponding CEE sockets of the **measuring adapter**.
- Connect the test probe of your appliance tester to the PE socket (see pos. 1, chapter 4) of the **measuring adapter**.
- Start the R_{PE} measurement on your appliance tester.
- Read the R_{PE} measuring result shown on the display of the appliance tester.
- Subtract the measured R_{PE} value of the **measuring adapter** from the R_{PE} measuring result of the test sample.

As a result, you will obtain the measured R_{PE} value of the test sample.

- Edit the measured R_{PE} value in the appliance tester according to the calculated measuring value.

Application

Cable test

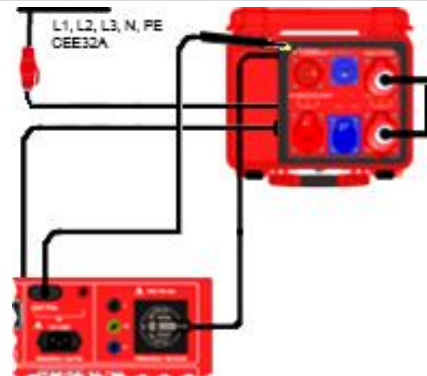

Connection diagram

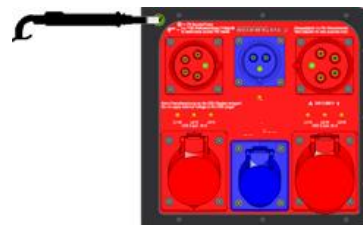

Detailed view

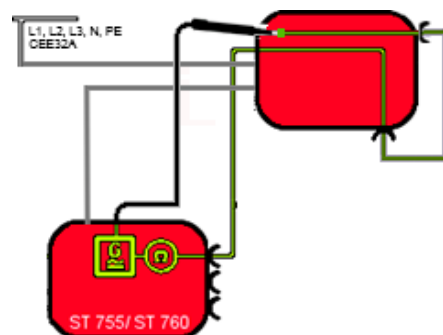

Circuit diagram

6.3.3. $R_{Insu} 1 - (LN-PE)$

Before testing

Switch the rotary switch (7) of the **measuring adapter** to position "L1-L2-L3".

The rotary switch (8) of the **measuring adapter** must be set to the position for **cable testing**.

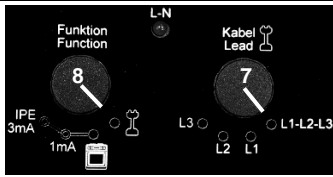

Test procedure (VDE 0701-0702)

Cable test

- Connect both cable connections to the corresponding CEE connectors of the **measuring adapter**.
- Start the R_{Insu} measurement on your appliance tester.

Application

Cable test

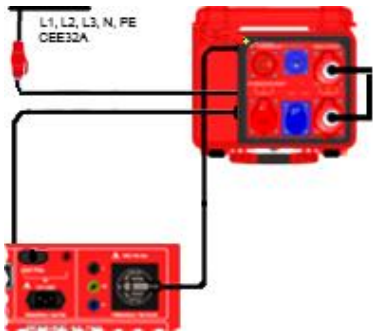

Connection diagram

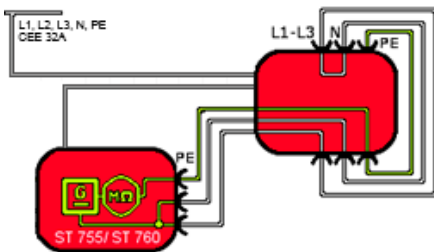

Circuit diagram

6.3.4. Functional test and phase sequence test of cables

Before testing

The functional test and phase sequence test of cables can be applied to CEE connecting cables and extension cables.



The measuring adapter is supplied with mains voltage.



The functional test and phase sequence test of cables may only be carried out after the R_{PE} and R_{Insu} tests have been passed.



For single-phase connecting cables or extension cables (CEE socket, 3-pin), the rotary switch must be set to the locking position "L1" or "L1-L2-L3".

Test procedure

Cable test

Switch the rotary switch (7) of the **measuring adapter** to position "L1-L2-L3".

The rotary switch (8) of the **measuring adapter** must be set to the position for **cable testing**.

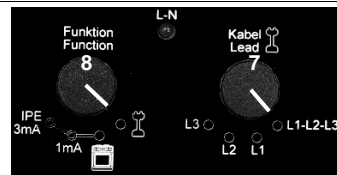

- Connect both cable connections to the corresponding CEE sockets of the **measuring adapter**.
- Switch the mains voltage to the test socket of the appliance tester.
- Observe the status LED indication of the corresponding CEE socket.
- Compare the indicated LED status with the function table in chapter 6.3.5.
- Successively turn the rotary switch (7) to the positions "L1", "L2" and "L3".

The LED indication must show the status "pass" in any rotary switch position.

Application

Cable test

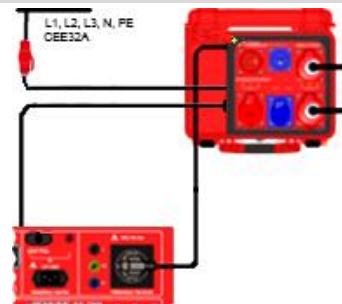

Connection diagram

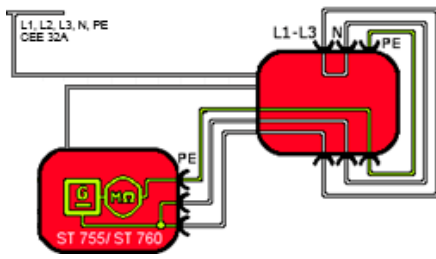

Circuit diagram

6.3.5. Function table

Rotary switch position	L1-N	L2-N	L3-N	Result
L1, L2, L3	●	●	●	L1, L2, L3 pass
	○	○	○	LN shorted or N interrupted
	○	●	●	L1 interrupted
	●	○	●	L2 interrupted
	●	●	○	L3 interrupted
L1	●	○	○	L1 pass
	○	○	○	L1-N shorted or L1 or N interrupted
	●	●	○	L1-L2 shorted
	●	○	●	L1-L3 shorted
L2	○	●	○	L2 pass
	○	○	○	L2-N shorted or L2 or N interrupted
	●	●	○	L1-L2 shorted
	○	●	●	L2-L3 shorted
L3	○	○	●	L3 pass
	○	○	○	L3-N shorted or L3 or N interrupted
	●	○	●	L1-L3 shorted
	○	●	●	L2-L3 shorted

Remarks concerning the function table

- LED status = switched on
- LED status = switched off

6.4. Testing of PRCDs and mobile power distributors (RCDs)

A portable residual current protection device (PRCD) provides protection against hazardous body currents in the downstream circuit in case of direct contact. The rated value for the tripping fault current depends on the appliance tester used and on the residual current protection device (RCD) used.

The following PRCDs/RCDs can be tested:

- PRCD S
- PRCD S+
- PRCD K
- PRCD AC
- PRCD A
- PRCD F
- PRCD B
- PRCD B+
- PRCD 2-pin
- PRCD 3-pin
- Mobile power distributors (RCD) (types A, B)

For these tests, the MA 4 must be connected to the mains using the CEE 32 connector.



The ST 755 / 760 must be connected to the shock-proof socket of the measuring adapter.

The shock-proof plug of the measuring adapter must be connected to the test socket of the ST 755 / 760.

Before testing



Before starting the test, determine the internal R_{PE} resistance of the measuring adapter (see chapter 7).



Disconnect the test sample from the mains supply!



PRCD/RCD tests may only be carried out without load, as otherwise the appliance tester will be destroyed.

Symbol:



The rotary switch (7) of the measuring adapter can be used in any position for PRCD measurement.

The rotary switch (8) of the measuring adapter must be set to the position for appliance testing!

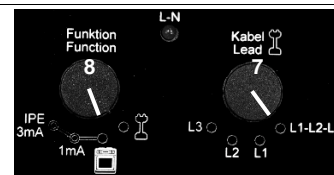

The rotary switch (8) of the measuring adapter must **not** be changed during the test.

Application



The PRCD / mobile power distributor (RCD) must be connected to the IEC socket of the ST 755 / 760.

Testing of PRCDs

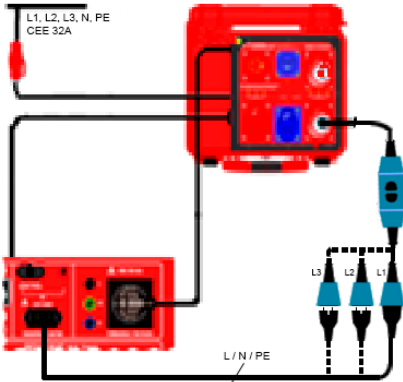

Connection diagram of PRCDs

Testing of mobile power distributors (PRCDs/RCDs)

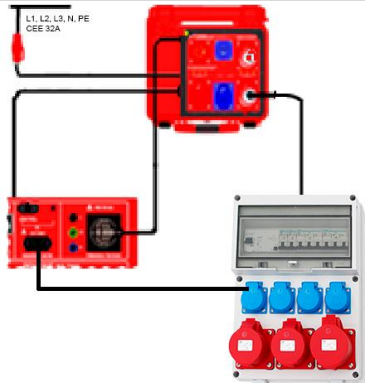

Connection diagram of mobile power distributors (RCDs)

Circuit diagram PRCD / power distributor (RCD)

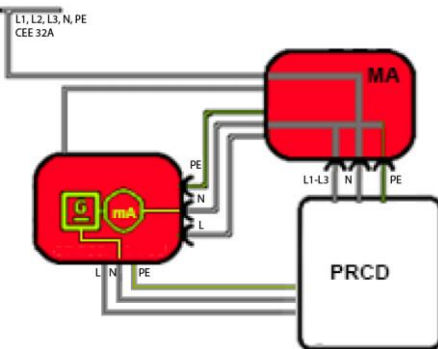

Circuit diagram for connection of PRCDs

The following measurements are supported in combination with the ST 755 / 760:

- Tripping current measurement
- Tripping time measurement
- Test key measurement

7. Internal R_{PE} resistance of the measuring adapter

R_{PE} measuring adapter

- Start the R_{PE} measurement on your appliance tester.
- Contact the test probe of the appliance tester with the PE contact (pos. 9, pos. 10 and pos. 11, chapter 4 “Operating elements”) of the corresponding CEE socket (see the figure “R_{PE} measuring adapter” below).
- Write down the measured R_{PE} value.
- Follow the test procedure **Class I, R_{PE}** for “portable test samples”.

Setup for measuring the internal R_{PE} resistance of the measuring adapter

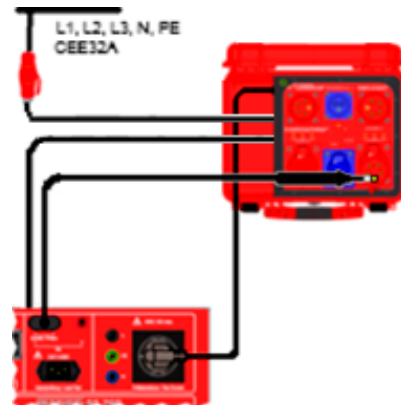

Connection diagram



Detailed view

8. Technical data

Nominal voltage	3*400 V ±10 %; 50 Hz – 60 Hz	
Current carrying capacity	32 A three-phase current	
Power consumption	"Mains active" 7 VA, cos φ ~ 0.4	
Protection class	Protection class I acc. to: EN / IEC 61010-1, VDE 0411-1	
Measuring category	II	
Contamination level	2	
EMC	EN 61326-1	
Measuring range	0.08 mA ... 10.0 mA AC	
Current accuracy	4 % of the measured value ±40 µA	
Measuring accuracy	6 % of the measured value ±60 µA	
Fault current source for the tester	N (differential current measuring method), PE (1 kΩ measuring resistance)	
Current source range	0.08 mA ... 10.0 mA AC	
Ambient conditions:	Altitudes of up to 2000 m above sea level	
Temperature range:		
Operating temperature	0.0 °C to 35.0 °C	
Storage temperature	-20.0 °C to 60.0 °C	
Max. relative humidity: linearly decreasing non-condensing	80.0 % at 30.0 °C 60.0 % at 40.0 °C	
Protection category	IP 40 with the case being open IP 67 with the case being closed	
Dimensions H x W x D	[mm]	170 x 410 x 350
Weight	4.2 kg	

9. Maintenance

Designation	Part no.
Measuring adapter	044162

The measuring adapter does not require any special maintenance. Please make sure that the surface near the connector contacts is clean and dry. For cleaning, use a slightly moistened cloth. Do not use any cleaning agents, abrasives or solvents.

10. Optional accessories

Figure	Designation	Item no.
	Adapter cable for the MA 4 16 A / 400 V CEE connector – 32 A / 400 V CEE coupling, Length: 1 m	044163

11. Warranty terms

The measuring adapter is subject to strict quality control. In case of faults with regard to correct functioning, we grant a manufacturer's warranty of 24 months. Manufacturing faults or material defects shall be eliminated by us free of charge as far as the device shows malfunction without external influence and is returned to us without having been opened. Damages caused by falling or incorrect use are excluded from warranty.

12. Service contacts

Spare parts management

Phone: +49 2871 93-553

E-mail: spareparts@benning.de

General service requests

Phone: +49 2871 93-556

E-mail: servicerequests@benning.de

Returns management

Phone: +49 2871 93-554

E-mail: returns@benning.de

Training management

Phone: +49 2871 93-557

E-mail: trainingscenter@benning.de

Technical support

Phone: +49 2871 93-555

E-mail: helpdesk@benning.de

BENNING

Support / helpdesk

BENNING helpdesk team

Phone: +49 2871 93-555

Fax: +49 2871 93-417

E-mail: helpdesk@benning.de

Website: www.benning.de