

Product Declaration Certificate

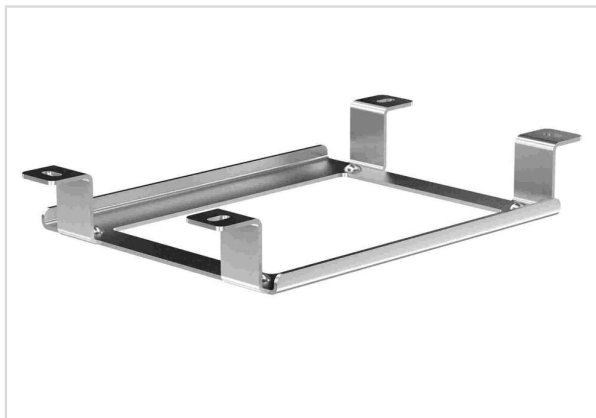

Image is for illustration purposes only. Please refer to product description.

Part number	24 98 100 0002
Specification	Ha-VIS MK3000 Cover60
HARTING eCatalogue	https://b2b.harting.com/24981000002

RoHS	compliant
ELV status	compliant
China RoHS	e
REACH Annex XVII substances	Not contained
REACH ANNEX XIV substances	Not contained
REACH SVHC substances	Not contained
California Proposition 65 substances	Yes

RoHS: Directive 2011/65/EU with all amending directives and regulations in force at the declaration's creation date.

ELV status: Directive 2000/53/EC with all amending directives and regulations in force at the declaration's creation date.

REACH ANNEX: Regulation (EU) No. 1907/2006 with all amending directives and regulations in force at the declaration's creation date.

REACH SVHC substances: We applied "Candidate List of substances of very high concern for Authorisation" of ECHA valid on the declaration's creation date.

ECHA SCIP: Article notification number in the SCIP Data base of the European Chemicals Agency (ECHA) according to Waste Frame Directive 2008/89/EC with amended directive 2018/851 in Article 9