

Montageanleitung

Ⓒ mounting instruction Ⓕ Notice de montage Ⓖ Instrukcja montażu
Ⓔ Instrucciones de montaje Ⓘ Istruzioni di montaggio

PURELIGHT-A

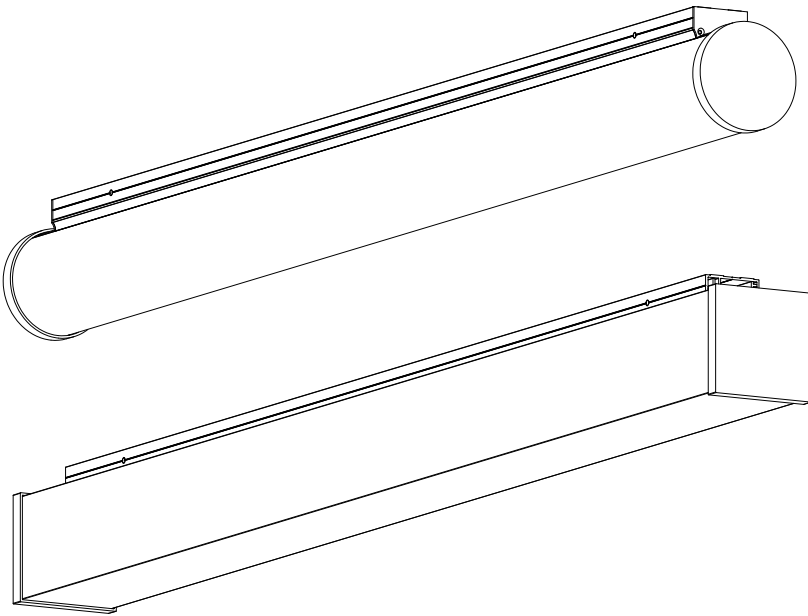

RIDI Leuchten GmbH
Hauptstrasse 31 - 33 · D-72417 Jungingen
Tel. 07477/872-0 · Fax 07477/872-48
kontakt@ridi-group.de · www.ridi-group.com



D Für die Installation und für den Betrieb der Leuchten sind die nationalen Sicherheitsvorschriften zu beachten.

GB Please note national safety instructions for installation and operation of this luminaire.

F Pour l'installation et le fonctionnement des luminaires il est impératif de respecter les normes nationales de sécurité en vigueur.

PL W celu prawidłowej instalacji i poprawnego działania oprawy należy przestrzegać krajowych przepisów bezpieczeństwa.

E Para la instalación y la puesta en funcionamiento de las luminarias deben observarse las normas nacionales de seguridad.

I Per l'installazione e il funzionamento delle lampade si fa riferimento alle normative di sicurezza nazionali.

D Die Lichtquelle dieser Leuchte darf nur vom Hersteller oder einem von ihm beauftragten Servicetechniker oder einer vergleichbar qualifizierten Person ersetzt werden.

GB Only the manufacturer, an instructed service technician or another equally qualified person is allowed to replace the light source of this luminaire.

F La source lumineuse de ce luminaire ne peut être remplacée que par le fabricant, un technicien de service mandaté par celui-ci ou une personne présentant une qualification analogue.

PL Wymiany źródła światła oprawy oświetleniowej może dokonać wyłącznie producent lub uprawniony pracownik serwisu lub osoba o podobnych kwalifikacjach.

E La fuente de luz de esta luminaria solamente podrá ser sustituida por el fabricante o una persona designada por este, ya sea un técnico de servicio u otra persona debidamente cualificada.

I La sorgente luminosa di tale lampada può essere sostituita solo dal produttore o da un tecnico di assistenza da questi designato oppure da personale dotato di qualifica equivalente.

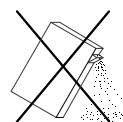
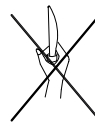
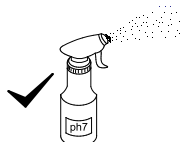
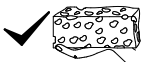

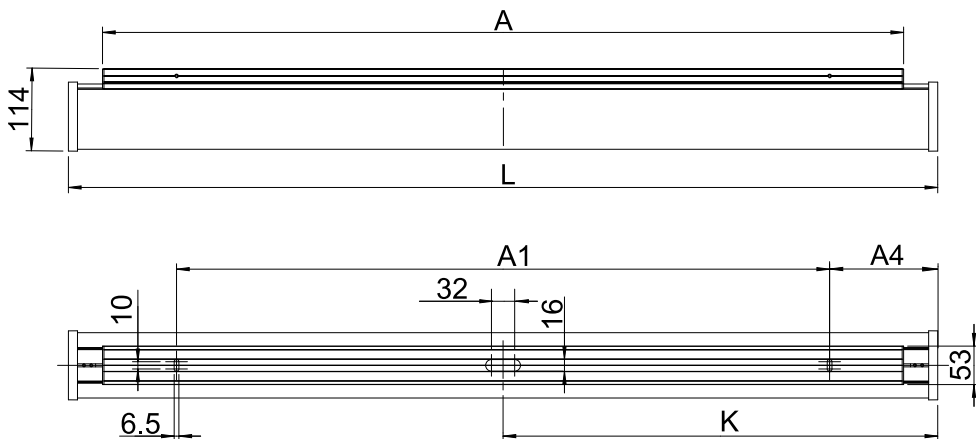

PURELIGHT-QA238	2389	2282	1400	495	1195	410N
PURELIGHT-QA179	1798	1691	900	449	899	310N
PURELIGHT-QA149	1503	1396		302	752	260N
PURELIGHT-QA120	1207	1100		154	604	220N
PURELIGHT-QA090	912	805		600	156	456
PURELIGHT-QA061	616	513	300	158	308	120N
PURELIGHT-RA238	2380	2286	1400	490	1190	400N
PURELIGHT-RA179	1789	1695	900	445	895	300N
PURELIGHT-RA149	1494	1400		297	747	250N
PURELIGHT-RA120	1198	1104		149	599	210N
PURELIGHT-RA090	903	809	600	152	452	160N
PURELIGHT-RA061	607	513	300	153,5	303,5	110N
Typ	L	A	A1	A4	K	

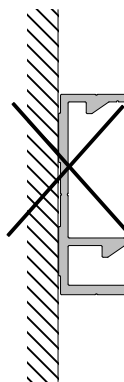
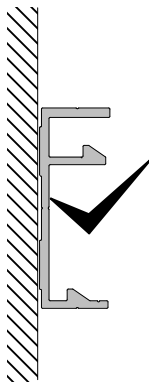
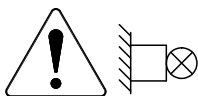

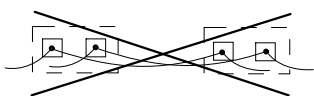
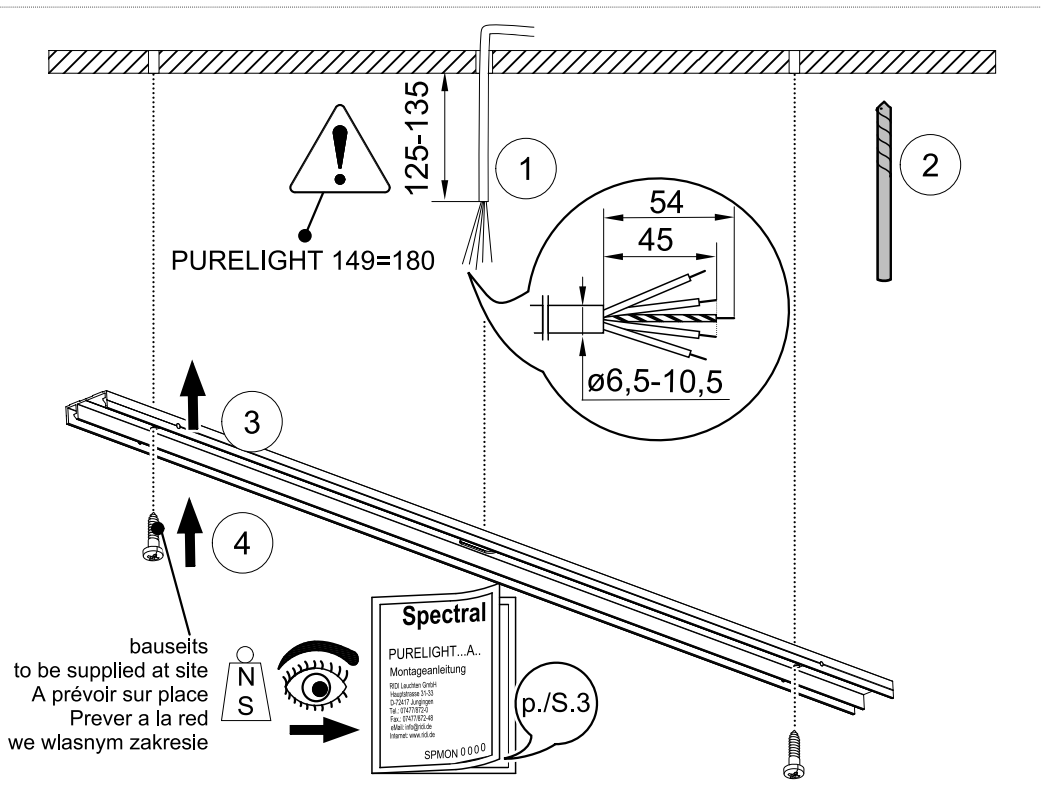

Spectral

AC 220-240 V

50-60 Hz

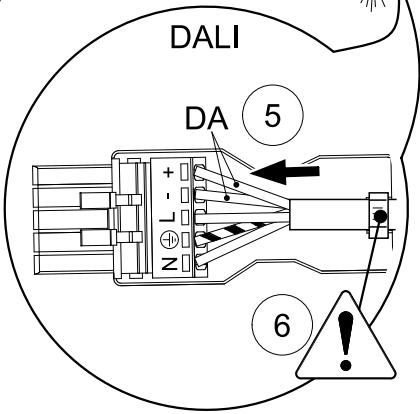
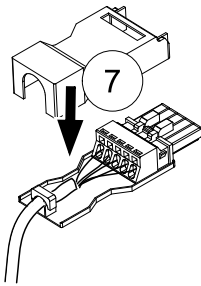
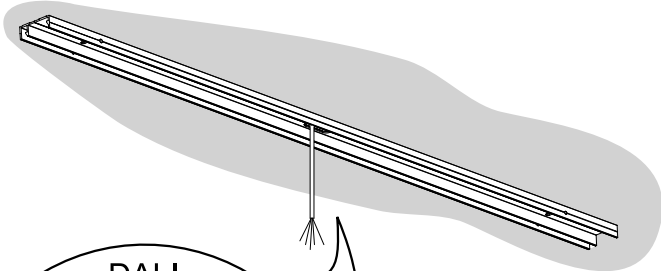

	mm ²	A
0,75mm ²	0,75	9

	mm ²	A
sol.	0,75-1,5	9
0,75-1,5mm ²		

