



Maßzeichnungen Instafix® BKI Installationskanal

Artikelnummer: IFAK030030w

Instafix® BKI Abschlusskappe 30 x 30 mm, reinweiß

GTIN 4251636715608

Maßzeichnungen:

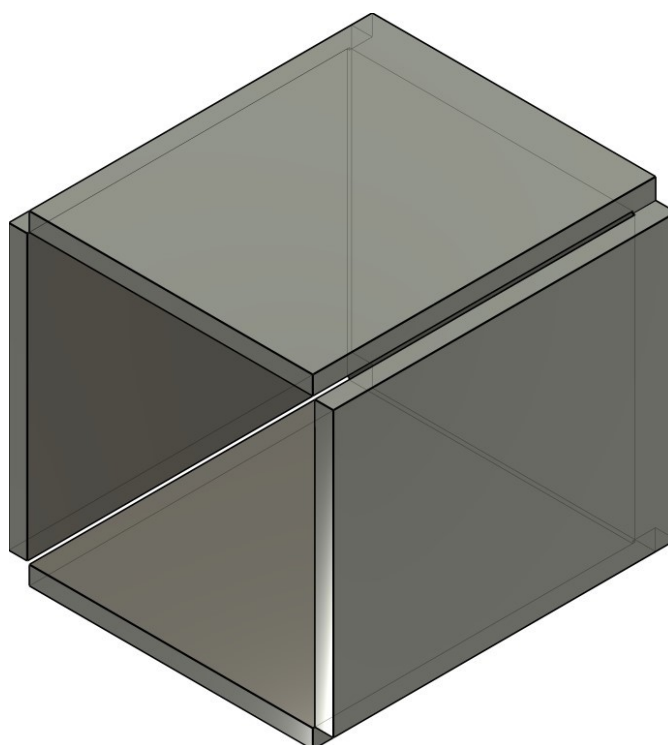
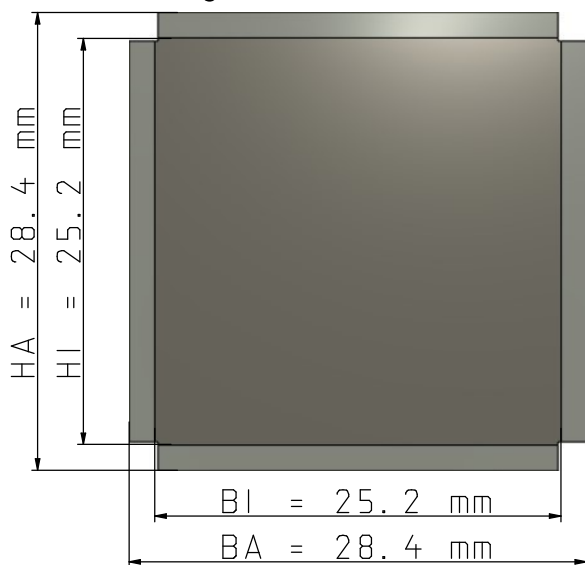

Einfach. Sicher. Für alle.

Wichmann Brandschutzsysteme GmbH & Co. KG • Siemensstraße 7 • 57439 Attendorn

Telefon: 02722 6382-0 • Telefax: 02722 6382-299 • E-Mail: info@wichmann.biz • www.wichmann.biz