

3:10

3:10

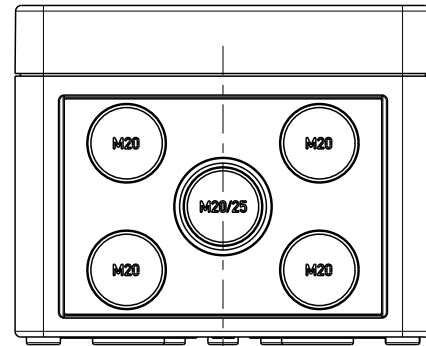

A-A

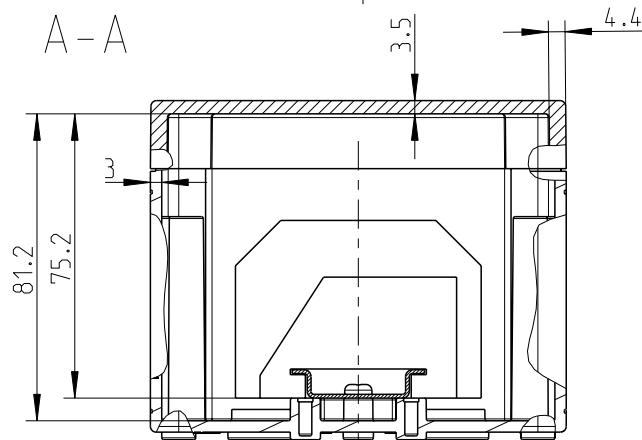

Ansicht ohne Deckel  
view without cover

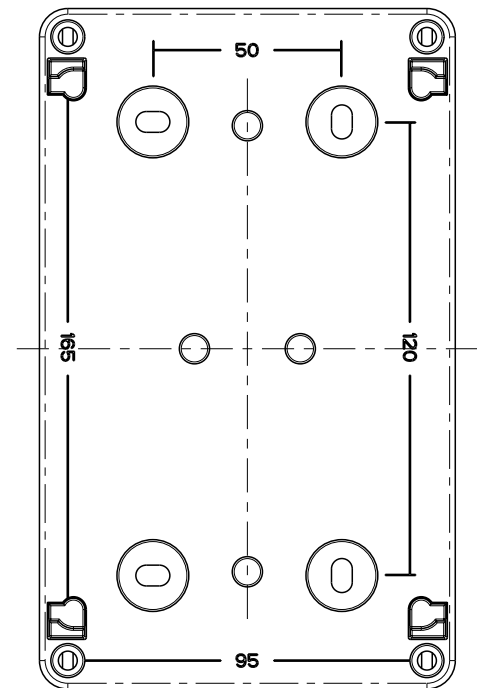
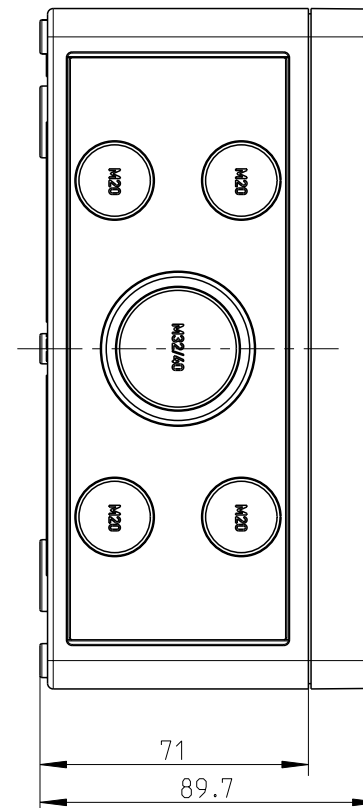
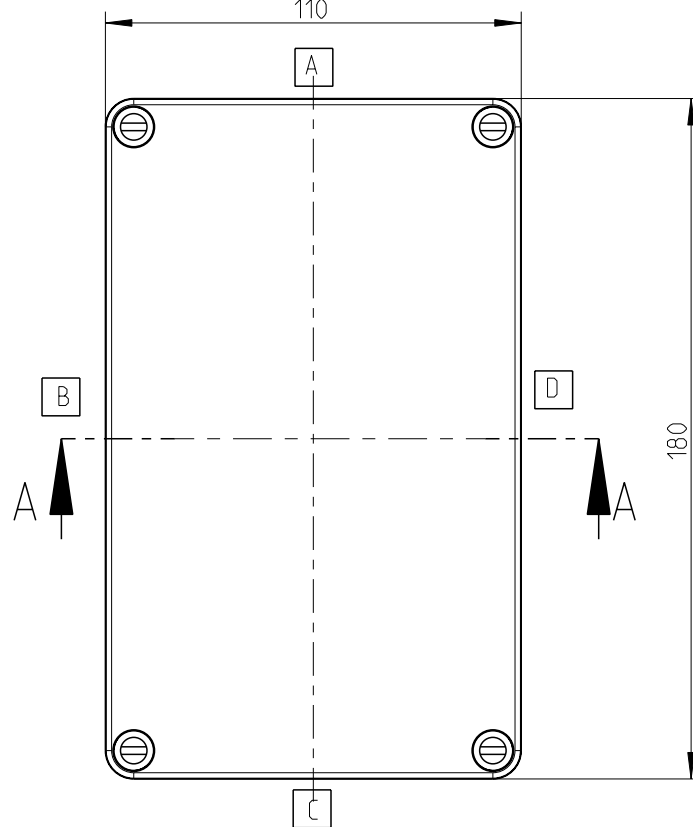
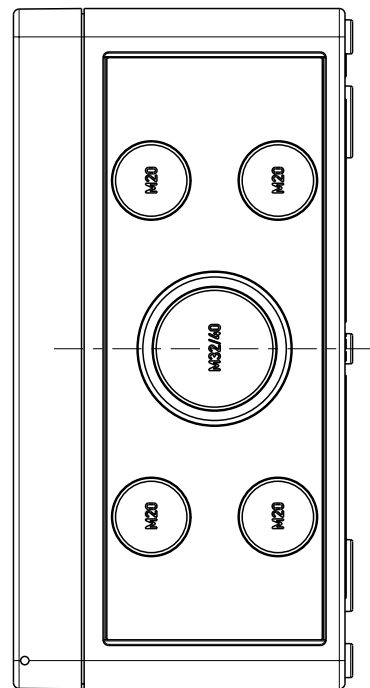
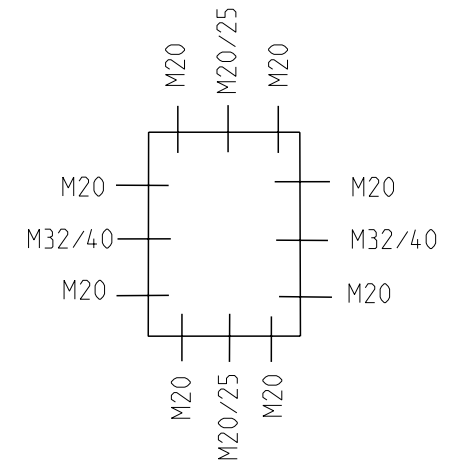
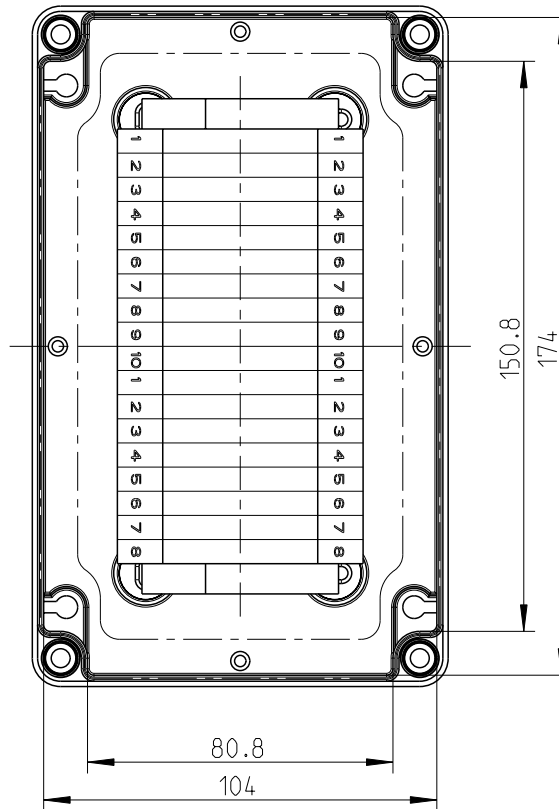

Fehlende Maße können dem Massblatt M-TK-1811 entnommen werden  
missing size can be taken from the dimensional sheet M-TK-1811

Schutzvermerk ISO 16016 beachten. Refer to protection notice ISO 16016. Maßstab: 1:2

	Massblatt	
	RK 4/18 K-18x4 <sup>2</sup> M-RK 4/18 K-18/4 <sup>2</sup>	
<small>0</small> Freigabe <small>07.04.16</small>	<small>(Dateiname Modell:) M-615-018-01</small>	<small>(Dateiname Zeichnung) M-615-018-01</small>